

2020

LEVEL OF DEVELOPMENT (LOD) SPECIFICATION PART I & COMMENTARY

For Building Information Models and Data

December 2020

Committee Co-Chairs
Jim Bedrick, FAIA, Will Ikerd, P.E., Jan Reinhardt

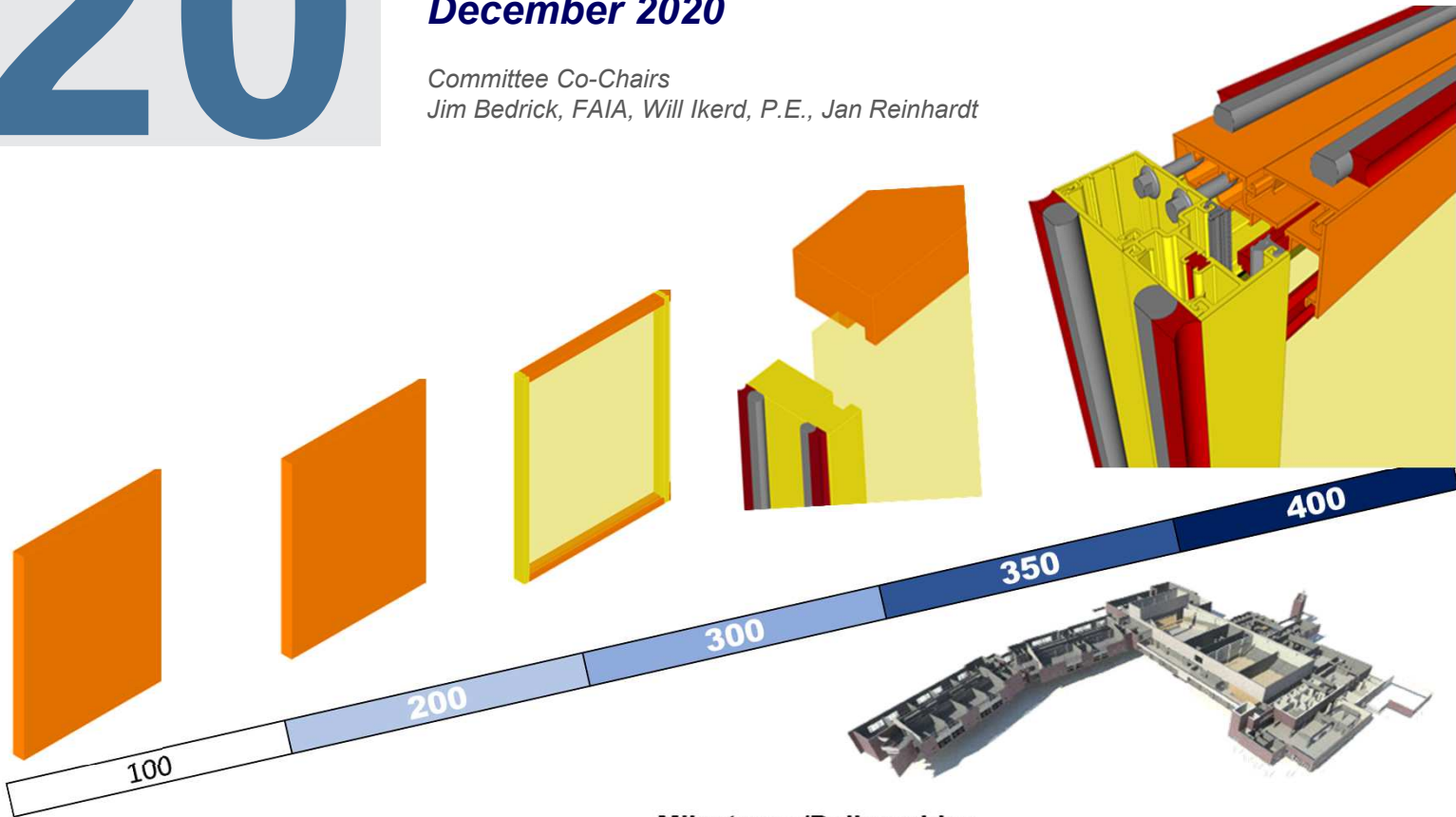

Milestones/Deliverables

		SD		DD		CD	Constr. Coord.	Fabrication
Building Systems	—							
	—							
	—							
	—							
	—							
	—							
	—							
	—							

PARTICIPATING ORGANIZATIONS



LOD Spec 2020

For Building Information Models

Part I

December 2020

Nothing contained in this work shall be considered the rendering of legal advice. Readers are responsible for obtaining such advice from their own legal counsel. This work and any forms herein are intended solely for educational and informational purposes.

All images are intended to illustrate building conditions in compliance with common building codes. However, the images do not take into account site specific conditions, regional building codes and other important information that may require a material change for specific projects. These illustrations do not make representation for fitness for a particular project nor for code or design compliance.

Copyright © 2020 by BIMForum. All rights reserved

The LOD Specification Part I and Part II as well as the LOD Specification Guide are made available to the public without charge. In order to maintain the integrity and usefulness of these documents as a reference standard, certain restrictions apply to their use. These documents are licensed to the public under Creative Commons licenses as follows:

Part I of this work is licensed under the Creative Commons Attribution-NonCommercial-NoDerivatives 4.0 International License (<http://creativecommons.org/licenses/by-nc-nd/4.0/>).

Part II of this work is licensed under the Creative Commons Attribution-NonCommercial 4.0 International License (<http://creativecommons.org/licenses/by-nc/4.0/>).

The LOD Spec Guide is licensed under the Creative Commons Attribution-NonCommercial-NoDerivatives 4.0 International License (<http://creativecommons.org/licenses/by-nc-nd/4.0/>).

Licensing questions should be directed to LOD@BIMForum.org.



ACKNOWLEDGEMENTS

Many thanks to all the individuals and organizations who reviewed and contributed to this work, and to the following industry association representatives and co-chairs of the major discipline subgroups who made this document possible:

Chairs

Overall

Jim Bedrick, FAIA, AEC Process Engineering
Will Ikerd, PE, IKERD Consulting LLC
Jan Reinhardt, Adept Project Delivery

Domain Groups

Structures

Design

Will Ikerd, PE, LEED AP
IKERD

Construction

David Merrifield
National Institute of Steel Detailers

Exterior Skin

Michael F. Czap, AIA
The Beck Group

Will Ikerd, P.E.
IKERD

Interior Construction

Ron Dellaria, AIA, CSI
Collaborative Construction
Consultants

Brian Filkins
The Beck Group

South Cole
Texas Steel Tech LLC

Conveying

Brian Skripac, Assoc. AIA,
LEED AP BD+C
Cannon Design

Ken Flannigan, LEED AP
KONE

Building Services

Mark Mergenschroer
Bernhardt TME

David Francis
ICT Tracker

Joseph Powell
IKERD

Civil

Will Ikerd, PE, LEED AP
IKERD

Jake Fears, PE
JHF Engineering

Landscape

Elise Bertret
Tract Consultants

Jan Reinhardt,
Adept Project Delivery

Will Ikerd, PE, LEED AP
IKERD

Jake Fears, PE
JHF Engineering

Bridge: Highway & Rail

Will Ikerd, PE, LEED AP
IKERD

David Merrifield
National Institute of Steel Detailers

Estimating with BIM

Brent pilgrim
Beck Group

Ryan Short
Rudick Construction

Michael Perdue
IKERD

Nicholas Grinnan
Rudick Construction

Data with BIM

Michael Perdue
IKERD

Jan Reinhardt,
Adept Project Delivery

Legal

Carl G. Roberts,
Law Offices of Carl G. Roberts LLC



Industry Association Representatives

Michael Bomba, Esq., American Institute of Architects

Overall Editing and Graphics Creation

Ascend Building Knowledge Foundation (AscendBKF.org), Technical Writing, Editing & Graphics
IKERD Consulting, LLC (IKERD.com), Editing
BIMxD Solutions, LLC (BIMxD.com), Graphics

Additional Contributors

In addition, we'd like to thank the many contributors from all sectors of the industry who helped make this specification possible, including:

Andy Jizba, US CAD

Benjamin Crosby, Yates Construction

Bill Klorman, Klorman Construction & ACI 131 BIM Committee Member (Concrete)

Brenda Ikerd, IKERD Consulting, IKERD.com (Structures, Civil)

Chuck Eastman, Ph.D, Georgia Institute of Technology

Jamie L. Davis, PE, LEED AP, Ryan Biggs | Clark Davis Engineering & Surveying (Masonry)

Jason P. Lien, PE, Precast Concrete Institute (PCI) BIM Committee, EnCon United (Precast)

Jonathan Koller, IKERD Consulting, IKERD.com (Graphics Editing, Structures, and Anchors)

Joe Cipra, Vulcraft/Verco Group (Structural Steel Open Web Joists and Metal Deck)

Joe Powell, EIT, Ikerd Consulting, IKERD.com (MEP)

Kirk Capristo, Astorino (Cover)

Lee Garduno, Southland Industries (MEP)

Luke Faulkner, LEED AP, AISC (Structural Steel)

Matthew J. Gomez PE, SE, Trimble (Structural Steel)

Michael Bolduc, PE (MA), Simpson Gumpertz & Heger (Structural)

Michael Gustafson, PE, Autodesk (Structural)

Michael Mulder, Southland Industries (MEP)

Michael Perdue, Ikerd Consulting, IKERD.com (LOD Part II Data Tables)

Murat Karakas, Arup (MEP)

Paul J. Hause, PE, Structural Consultants Inc. (Structural)

Peter J. Carrato, Ph.D., PE, SE, Bechtel & ACI 131 BIM Committee Chair (Concrete)

R. Wayne Muir, P.E., Structural Consultants Inc. & SEI-CASE BIM Committee Co-Chair (Structures)

Roger Becker, PE, SE, Precast Concrete Institute (PCI) Managing Director of Research and Development (Precast)

Scott Babin, ITW Building Components Group (Wood)

Soheil Seiqali, Klorman Construction (Concrete)

Steven Bumbalough (Wood)

William Northcutt, IKERD Consulting, IKERD.com (Graphics Editing, Structures, and Anchors)



EXECUTIVE SUMMARY

For a detailed guide on the use of this Specification see [LOD Spec Guide](#) at the end of this document.

The Level of Development (LOD) Specification is a reference tool intended to improve the quality of communication among users of Building Information Models (BIMs) about the characteristics of elements in models. The *LOD Specification* expands upon the LOD schema developed by the American Institute of Architects (AIA) for its *E202-2009 BIM and Digital Data Exhibit* and updated for the AIA's *G202-2013 Project BIM Protocol Form*¹ by providing definitions and illustrations of BIM elements of different building systems at different stages of their development and use in the design and construction process.

Building Information Modeling presents information about a construction project or structure in the form of three-dimensional graphical representations of elements (e.g., doors, beams, etc.), which can be further associated with information about other characteristics of those elements. It is possible for the graphical representation of an element, taken alone, to suggest that greater accuracy or intention can be attributed to the element than is in fact the case. The AIA's LOD Schema was developed to provide a more systematic way of conveying the extent of reliance that may be placed on an element. Many participants in the design and construction process felt, however, that the industry would benefit from a more detailed treatment of the AIA's brief narrative definitions.

Discussions within the BIMForum led to the creation of a multi-disciplinary task force to develop and maintain the *LOD Specification*. The *LOD Specification* is an organized collection of interpretations of the AIA's LOD definitions describing input and information requirements and providing graphical examples of the different levels of development of a broad variety of building element classes.

Users of the *LOD Specification* are cautioned that it does not prescribe the necessary levels of development for different steps in the construction process. That determination is left to each project team. It is believed, however, that the availability of more precise definitions will reduce the risks of miscommunication among members of project teams when the expectations for different stages in the design and construction process are established, through easier identification of what each member of the team is expected to deliver and greater predictability of the level of effort that is required to create each member's deliverables.

The *LOD Specification* is organized by CSI Unifomat 2010², with the subclasses expanded to Level 4 (and in a few cases to Level 5) to provide detail and clarity to the element definitions. The *LOD Specification* addresses only LOD 100 through LOD 400 of the AIA's LOD Schema, along with a new level – LOD 350 – which was added between LOD 300 and LOD 400 to better address the information levels required for effective trade coordination. The *LOD Specification* does not address LOD 500 since that LOD relates to field verification and is not an indication of progression to a higher level of geometry or information. See below for the Fundamental LOD Definitions.

The *LOD Specification* does not prescribe who the author of a particular component at a given LOD should be, as that will vary from one project to another. However, the document does provide a concise schematic means through the spreadsheet in Part II for a project team to identify model element authors, again in the interest of improving communication among model users. In addition, the *LOD Specification* task force has been working with software developers to provide a means within the software of tagging individual elements within a model with their current LOD level.

The *LOD Specification* is intended as a reference standard, but is also intended to evolve as the use of BIM develops. The Specification is updated annually, and previous versions are maintained on the BIMForum website (www.bimforum.org/lo). Users are invited to provide comments and recommendations for consideration in future editions. These should be sent by email to LOD@BIMForum.org.

¹ AIA Contract Document *G202-2013, Building Information Modeling Protocol Form* is part of a series of digital practice documents the AIA published in June 2013. This series consists of *AIA E203™–2013, Building Information Modeling and Digital Data Exhibit*, *AIA G201™–2013, Project Digital Data Protocol Form*, and *AIA G202™–2013, Project Building Information Modeling Protocol Form*. For general information on the documents and downloadable samples see www.aia.org/digitaldocs. For executable versions of the documents see <http://www.aia.org/contractdocs>.

² UniFormat™ Numbers and Titles used in this publication are from UniFormat™, published by CSI and Construction Specifications Canada (CSC), and are used with permission from CSI. For a more in-depth explanation of UniFormat™ and its use in the construction industry visit <http://www.csinet.org> or contact CSI, 110 South Union Street, Suite 100, Alexandria, VA 22314. (800) 689-2900.



CONTENTS

EXECUTIVE SUMMARY	5
CHANGES FROM 2019 VERSION	12
UPDATES OF THIS DOCUMENT	13
FUNDAMENTAL LOD DEFINITIONS	15
PART I – ELEMENT GEOMETRY	17
N/A 36-51 OFFICE RESOURCES	17
N/A 36-51 73 11 13 11 19 SPACES	17
N/A 36-51 73 11 13 17 11 Horizontal Grids	18
N/A 36-51 73 11 13 17 13 Vertical Levels.....	18
A 21-01 SUBSTRUCTURE	20
A10 21-01 10 Foundations	20
A1010 21-01 10 10 Standard Foundations	20
A1020 21-01 10 20 Special Foundations.....	26
A20 21-01 20 Subgrade Enclosures.....	31
A2010 21-01 20 10 Walls for Subgrade Enclosures	32
A40 21-01 40 Slabs-on-Grade	33
A4010 21-01 40 10 Standard Slabs-on-Grade	33
A4020 21-01 40 20 Structural Slabs-on-Grade	34
A4030 21-01-40-30 Slab Trenches TBD	35
A4040 21-01-40-40 Pits and Bases TBD.....	35
A4090 21-01-40-90 Slab-On-Grade Supplementary Components TBD	36
A60 21-01-60 Water and Gas Mitigation TBD	36
A6010 21-01-60-10 Building Subdrainage TBD.....	36
A6020 21-01-60-20 Off-Gassing Mitigation TBD	36
A90 21-01-90 Substructure Related Activities TBD.....	36
A9010 21-01-90-10 Substructure Excavation TBD.....	36
A9020 21-01-90-20 Construction Dewatering TBD	36
A9030 21-01-90-30 Excavation Support TBD	36
A9040 21-01-90-40 Soil Treatment TBD	36
B 21-02 00 00 SHELL.....	37
B10 21-02 10 Superstructure	37
B1010 21-02 10 10 Floor Construction.....	37
B1020 21-02 10 20 Roof Construction	60
B1080 21-02 10 80 Stairs	61
B20 21-02 20 Exterior Vertical Enclosures.....	69
B2010 21-02 20 10 Exterior Walls	70
B2020 21-02 20 20 Exterior Windows	83
B2050 21-02 20 50 Exterior Doors and Grilles	88
B2070 Exterior Louvers and Vents	90
B30 21-02 30 Exterior Horizontal Enclosures.....	92



B3010	21-02 30 10 Roofing.....	92
B3020	21-02 30 20 Roof Appurtenances	93
B3040	21-02 30 40 Traffic Bearing Horizontal Enclosures	94
B3060	21-02 30 60 Horizontal Openings.....	96
B3080	21-02 30 80 Overhead Exterior Enclosures	96
C	21-03 INTERIORS.....	98
C10	21-03 10 Interior Construction.....	98
C1010	21-03 10 10 Interior Partitions	98
C1020	21-03 10 20 Interior Windows	109
C1030	21-03 10 30 Interior Doors	110
C1040	21-03 10 40 Interior Grilles and Gates	113
C1060	21-03 10 60 Raised Floor Construction.....	113
C1070	21-03 10 70 Suspended Ceiling Construction	114
C1090	21-03 10 90 Interior Specialties.....	116
C20	21-03 20 Interior Finishes	118
C2010	21-03 20 10 Wall Finishes.....	118
C2020	21-03 20 20 Interior Fabrications	120
C2030	21-03 20 30 Flooring.....	120
C2040	21-03 20 40 Stair Finishes	123
C2050	21-03 20 50 Ceiling Finishes.....	123
D	21-04 00 00 SERVICES	124
D10	21-04 10 Conveying.....	124
D1010	21-04 10 10 Vertical Conveying Systems.....	124
D1030	21-04 10 30 Horizontal Conveying	128
D1050	21-04 10 50 Material Handling	128
D1080	21-04 10 80 Operable Access Systems	132
D20	21-04 20 Plumbing.....	133
D2010	21-04 20 10 Domestic Water Distribution.....	133
D2020	21-04 20 20 Sanitary Drainage	138
D2030	21-04 20 30 Building Support Plumbing Systems	141
D2050	21-04 20 50 General Service Compressed-Air.....	146
D2060	21-04 20 60 Process Support Plumbing Systems.....	146
D30	21-04 30 Heating, Ventilation, and Air Conditioning (HVAC)	148
D3010	21-04 30 10 Facility Fuel Systems	148
D3020	21-04 30 20 Heating Systems	152
D3030	21-04 30 30 Cooling Systems	154
D3050	21-04 30 50 Facility HVAC Distribution Systems	157
D3060	21-04 30 60 Ventilation	160
D3070	21-04 30 70 Special Purpose HVAC Systems	164
D40	21-04 40 Fire Protection	165
D4010	21-04 40 10 Fire Suppression.....	165



D4030	21-04 40 30 Fire Protection Specialties.....	167
D50	21-04 50 Electrical.....	168
D5010	21-04 50 10 Facility Power Generation.....	168
D5020	21-04 50 20 Electrical Service and Distribution.....	170
D5030	21-04 50 30 General Purpose Electrical Power.....	174
D5040	21-04 50 40 Lighting.....	176
D5080	21-04 50 80 Miscellaneous Electrical Systems.....	178
D60	21-04 60 Communications.....	179
D6010	21-04 60 10 Data Communications.....	180
D6020	21-04 60 20 Voice Communications.....	182
D6030	21-04 60 30 Audio-Video Communication.....	182
D6060	21-04 60 60 Distributed Communications and Monitoring.....	182
D6090	21-04 60 90 Communications Supplementary Components.....	182
D70	21-04 70 Electronic Safety and Security.....	182
D7010	21-04 70 10 Access Control and Intrusion Detection.....	182
D7030	21-04 70 30 Electronic Surveillance.....	182
D7050	21-04 70 50 Detection and Alarm.....	183
D7070	21-04 70 70 Electronic Monitoring and Control.....	183
D7090	21-04 70 90 Electronic Safety and Security Supplementary Components.....	183
D80	21-04 80 Integrated Automation.....	183
D8010	21-04 80 10 Integrated Automation Facility Controls.....	183
E	21-05 00 00 EQUIPMENT & FURNISHINGS.....	184
E10	21-05 10 Equipment.....	184
E1010	21-05 10 10 Vehicle and Pedestrian Equipment.....	184
E1030	21-05 10 30 Commercial Equipment.....	185
E1040	21-05 10 40 Institutional Equipment.....	187
E1060	21-05 10 60 Residential Equipment.....	188
E1070	21-05 10 70 Entertainment and Recreational Equipment.....	188
E1090	21-05 10 90 Other Equipment Associated Masterformat Sections: 11 90 00.....	189
E20	21-05 20 Furnishings.....	190
E2010	21-05 20 10 Fixed Furnishings.....	190
E2050	21-05 20 50 Movable Furnishings.....	191
F	21-06 00 00 SPECIAL CONSTRUCTION & DEMOLITION.....	193
F10	21-06 10 Special Construction.....	193
F1010	21-06 10 10 Integrated Construction.....	193
F1020	21-06 10 20 Special Structures.....	193
F1030	21-06 10 30 Special Function Construction.....	201
F1050	21-06 10 50 Special Facility Components.....	201
F1060	21-06 10 60 Athletic and Recreational Special Construction.....	201
F1080	21-06 10 80 Special Instrumentation.....	202
F20	21-06 20 Facility Remediation Associated Masterformat Sections:.....	202



F2010	21-06 20 10 Hazardous Materials Remediation	202
F30	21-06 30 Demolition	202
F3010	21-06 30 10 Structure Demolition	202
F3030	21-06 30 30 Selective Demolition	202
F3050	21-06 30 50 Structure Moving	202
G10	21-07 10 Site Preparation	202
G1010	21-07 10 10 Site Clearing	203
G1020	21-07 10 20 Site Elements Demolition	203
G1030	21-07 10 30 Site Element Relocations	203
G1050	21-07 10 50 Site Remediation	203
G1070	21-07 10 70 Site Earthwork	203
G20	21-07 20 Site Improvements	204
G2010	21-07 20 10 Roadways	205
G2020	21-07 20 20 Parking Lots	205
G2030	21-07 20 30 Pedestrian Plazas and Walkways	206
G2040	21-07 20 40 Airfields	207
G2050	21-07 20 50 Athletic, Recreational, and Playfield Areas	207
G2060	21-07 20 60 Site Development	208
G2080	21-07 20 80 Landscaping	208
G30	21-07 30 Liquid and Gas Site Utilities	208
G3010	21-07 30 10 Water Utilities	209
G3020	21-07 30 20 Sanitary Sewerage Utilities	209
G3030	21-07 30 30 Storm Drainage Utilities	210
G3050	21-07 30 50 Site Energy Distribution	210
G3060	21-07 30 60 Site Fuel Distribution	210
G3090	21-07 30 90 Liquid and Gas Site Utilities Supplementary Components	211
G40	21-07 40 Electrical Site Improvements	211
G4050	21-07 40 50 Site Lighting	212
G50	21-07 50 Site Communications	213
	G5010 – Site Communications Systems	213
G90	21-07 90 Miscellaneous Site Construction	214
	G9010 21-07 90 10 Tunnels	214
N/A	22-31 23 16 13 Trenches	215
N/A	23-13 STRUCTURAL AND EXTERIOR ENCLOSURE PRODUCTS	216
N/A	23-13-23 Mechanical Fasteners, Adhesives, and Sealants	216
N/A	23-13 23 11 Mechanical Fasteners – L-Bolt	216
N/A	23-13 23 11 Mechanical Fasteners – J-Bolt	218
N/A	23-13 23 11 Mechanical Fasteners – Hex Head Bolt with Washer	219
N/A	23-13 23 11 Mechanical Fasteners – Welded Headed Stud Bolt	221
N/A	23-13 23 11 Mechanical Fasteners – Adhesive Anchor	222
N/A	23-13 23 11 Mechanical Fasteners – Undercut Anchor	224



N/A	23-13 23 11	Mechanical Fasteners – Torque-controlled Expansion Anchor (Sleeve Type)	226
N/A	23-13 23 11	Mechanical Fasteners – Torque-controlled Expansion Anchor (Stud Type)	228
N/A	23-13 23 11	Mechanical Fasteners – Drop-in Type Displacement-Controlled Expansion Anchor	230
N/A	23-13 31	Structural Concrete Products	232
N/A	23-13 31 17	Formwork– Concrete Column	232
N/A	23-13 31 17	Formwork– Concrete Slab	234
N/A	35-51-11 11 11 11	Site Trailers	236
N/A	35-51 11 11 11 27	Site Lighting	237
CIVIL			239
		Highway Bridges Precast Structural I Girder (Concrete)	239
		Highway Bridge Girder Steel	242
		Railroad Bridges Precast Structural I Girder (Concrete)	243
		Railroad Bridge Girder Steel	245
GUIDE AND COMMENTARY			249
EXECUTIVE SUMMARY			252
CONTENTS			253
CHANGES FROM 2019 VERSION			259
UPDATES OF THIS DOCUMENT			260
1 OVERVIEW			260
1.1 Description			260
1.1.1 LODs and Design Phase			261
1.1.2 LODs and Model Definition			261
1.2 Intent			261
1.2.1 Not a Set of Requirements			261
1.2.2 Complements a BIM Execution Plan (BIMXP)			261
1.3 Background			262
1.3.1 AIA Effort			262
1.3.2 BIMForum Effort			262
1.3.3 LOD Definitions			262
2 LEVELS OF DEVELOPMENT			262
2.1 BIM as a Communication Tool			262
2.2 Level of Development vs. Level of Detail			263
2.3 Fundamental LOD Definitions			263
2.3.1 LOD 100			263
2.3.2 LOD 200			263
2.3.3 LOD 300			263
2.3.4 LOD 350			264
2.3.5 LOD 400			264
2.3.6 LOD 500 [NOT USED]			264
2.4 Example – Light Fixture:			264
3 USING THE SPECIFICATION			265



- 3.1 Glossary 265
 - 3.1.1 Actual: 265
 - 3.1.2 BXP, BEP 265
 - 1.1.1 Specific:..... 265
- 3.2 Details 265
 - 3.2.1 Order of Precedence 265
 - 3.2.2 LOD Definitions as Minimum Requirements..... 265
 - 3.2.3 LOD Definitions are Cumulative 265
 - 3.2.4 Model Element Author 265
 - 3.2.5 2D Supplementary Drawings..... 266
- 3.3 Project-Specific Information 266
 - 3.3.1 Size Thresholds 266
- 3.4 Using the Specification with a BIMXP 266
 - 3.4.1 Reliance 266
 - 3.4.2 Multiple uses 266
 - 3.4.3 Efficient sequencing 266
 - 3.4.4 Avoidance of over-modeling..... 266
- 3.5 Implementation of the Specification 267
 - 3.5.1 Rely on the Model Element Table 267
 - 3.5.2 Include LOD Designations as Attributes of Individual Model Elements 267
- 4 ORGANIZATION OF THE SPECIFICATION..... 268
 - 4.1 Geometric and Attribute Information 268
 - 4.1.1 Part I: Element Geometry 268
 - 4.1.2 Part II: Associated Attribute Information 268
 - 4.1.3 Model Element Table 268
 - 4.1.4 Building Systems..... 268
 - 4.1.5 Milestones/Deliverables 269
 - 4.1.6 Attribute Tables 269
 - 4.1.7 Attribute Table Anatomy 270
 - 4.1.8 MEPF Attribute Tables 270
 - 4.1.9 Using the Attribute Tables 271
- 5 SUPPLEMENTARY GUIDELINES 272
 - 5.1 Clearly Define the Local X,Y,Z Origin: Basis for all LOD By Will Ikerd, P.E. 272



CHANGES FROM 2019 VERSION

Note – Changes in the Element Geometry section are indicated with a change bar in the left margin. Items such as grammar corrections, added Unifomat descriptions, added Masterformat references, added or upgraded graphics, minor corrections/additions, etc. are marked with a bar but not detailed in this section. Minor grammatical and typo corrections are not indicated.

Specific Changes

Part I

Unifomat	Omniclass		
B1010.50	21-02 10 10 50	Ramps	Content added
D1050.10	21-04 10 50 10	Cranes	LOD 300, 350 modified
F10.20.40	21-06 10 20 40	Special Structures: Metal Building Systems	Modified
G20	21-07 20	Site Improvements	LOD 200 modified
G2030	21-07 20 30	Pedestrian Plazas and Walkways	Content added
G2050	21-07 20 50	Athletic, Recreational, and Playfield Areas	Content added
G2080	21-07 20 80	Landscaping	Content added
N/A	22-31 23 16 13	Trenches	Content added
N/A	35-51 11 11 11 11	Trailers	Content added
N/A	35-51 11 11 11 27	Site Lighting:	Content added
N/A	35-51 17 27	Temporary Fencing:	Content added
N/A	35-61 31 31 21 51 26	Batch Plants:	Content added

Part II

Model Element Table	All elements listed in CSI's Unifomat 2010 have been included in the spreadsheet regardless of whether they have been addressed in Part I.
Notes tab	Added



UPDATES OF THIS DOCUMENT

While this document is intended as a reference that can be cited in agreements such as contracts and BIM execution plans, it is recognized that the use of BIM in design and construction is evolving. To accommodate this evolution this document will be updated periodically in clearly identifiable versions. A project can adopt a specific version and then has the option to remain with that version or update if a new version is published. Initially the target update frequency is annually, but that may change in the future. In addition, interim updates may be issued if needed.

Revision History

11/23/2020	Level of Development Specification 2020 DRAFT FOR PUBLIC COMMENT	
01/18/2019	Level of Development Specification 2019	
09/25/2018	Level of Development Specification 2019 DRAFT FOR PUBLIC COMMENT	
09/04/2018	Level of Development Specification 2018	
07/16/2018	Level of Development Specification 2018 DRAFT FOR PUBLIC COMMENT	
11/07/2017	Level of Development Specification 2017	
08/25/2017	Level of Development Specification 2017 DRAFT FOR PUBLIC COMMENT	
10/17/2016	Level of Development Specification 2016	
08/25/2016	Level of Development Specification 2016 DRAFT FOR PUBLIC COMMENT	Definitions have not been changed except for minor grammatical corrections and formatting. Engineered metal building structures, precast concrete, highway and rail road bridge content moved from Appendix to main body.
10/30/2015	Level of Development Specification 2015	Definitions have not been changed except for minor grammatical corrections and formatting. New content released as an Appendix to Part A for engineered metal building structures, precast concrete, highway bridge content and rail road bridge content.
4/30/2015	Level of Development Specification 2015 DRAFT FOR PUBLIC COMMENT	Definitions have not been changed except for minor grammatical corrections and formatting. Part B, Model Element Table, and Attribute Tables were added.
12/30/2014	Level of Development Specification 2014	Definitions have not been changed except for minor grammatical corrections and formatting. Images and image notes have been added in <i>blue italics font</i> .
8/22/2013	Level of Development Specification 2013	
4/24/2013	Initial draft for public review	

Revision Process

Public Comment

Each new version is first released as a draft for public comment. Feedback is evaluated and resolved prior to the publishing of the official version.



Appendix

An increasing number of professional organizations are adopting this Specification and providing additional content relating to their domains. To accommodate information that becomes available after the public-comment release but prior to the final release, content is developed in collaboration with industry organizations and leading expert practitioners, and then vetted by the LOD working group. This content is released as an Appendix to Part A and as additional identified Attribute Table tabs in Part B. The new content is then integrated into the next public comment draft.



FUNDAMENTAL LOD DEFINITIONS³

LOD 100

The Model Element may be graphically represented in the Model with a symbol or other generic representation, but does not satisfy the requirements for LOD 200. Information related to the Model Element (i.e. cost per square foot, tonnage of HVAC, etc.) can be derived from other Model Elements.

BIMForum Interpretation: LOD 100 elements are not geometric representations. Examples are information attached to other model elements or symbols showing the existence of a component but not its shape, size, or precise location. Any information derived from LOD 100 elements must be considered approximate.

LOD 200

The Model Element is graphically represented within the Model as a generic system, object, or assembly with approximate quantities, size, shape, location, and orientation. Non-graphic information may also be attached to the Model Element.

BIMForum interpretation: At this LOD elements are generic placeholders. They may be recognizable as the components they represent, or they may be volumes for space reservation. Any information derived from LOD 200 elements must be considered approximate.

LOD 300

The Model Element is graphically represented within the Model as a specific system, object or assembly in terms of quantity, size, shape, location, and orientation. Non-graphic information may also be attached to the Model Element.

BIMForum interpretation: The quantity, size, shape, location, and orientation of the element as designed can be measured directly from the model without referring to non-modeled information such as notes or dimension call-outs. The project origin is defined and the element is located accurately with respect to the project origin.

LOD 350

The Model Element is graphically represented within the Model as a specific system, object, or assembly in terms of quantity, size, shape, location, orientation, and interfaces with other building systems. Non-graphic information may also be attached to the Model Element.

BIMForum interpretation: Parts necessary for coordination of the element with nearby or attached elements are modeled. These parts will include such items as supports and connections. The quantity, size, shape, location, and orientation of the element as designed can be measured directly from the model without referring to non-modeled information such as notes or dimension call-outs.

LOD 400

The Model Element is graphically represented within the Model as a specific system, object or assembly in terms of size, shape, location, quantity, and orientation with detailing, fabrication, assembly, and installation information. Non-graphic information may also be attached to the Model Element.

BIMForum interpretation: An LOD 400 element is modeled at sufficient detail and accuracy for fabrication of the represented component. The quantity, size, shape, location, and orientation of the element as designed can be measured directly from the model without referring to non-modeled information such as notes or dimension call-outs.

³ The definitions for LOD 100, 200, 300, 400, and 500 included in this Specification represent the updated language that appears in Contract Document G202–2013, Project Building Information Modeling Protocol Form. The LOD 100, 200, 300, 400 and 500 definitions are used by permission. Copyright © 2013. ACD Operations, LLC. All rights reserved. LOD 350 was developed by the BIMForum working group. Copyright © 2013. The BIMForum and ACD Operations. All rights reserved.



LOD 500 [NOT USED]

The Model Element is a field verified representation in terms of size, shape, location, quantity, and orientation. Non-graphic information may also be attached to the Model Elements.

BIMForum interpretation. Since LOD 500 relates to field verification and is not an indication of progression to a higher level of model element geometry or non-graphic information, this Specification does not define or illustrate it.

Example – Light Fixture:

- 1) 100 cost/sf attached to floor slabs
- 2) 200 light fixture, generic/approximate size/shape/location
- 3) 300 Design specified 2x4 troffer, specific size/shape/location
- 4) 350 Actual model, Lightolier DPA2G12LS232, specific size/shape/location
- 5) 400 As 350, plus special mounting details, as in a decorative soffit



Unifomat Omniclass

PART I – ELEMENT GEOMETRY

N/A 36-51 OFFICE RESOURCES

N/A 36-51 73 11 13 11 19 SPACES

Associated Masterformat Sections: N/A

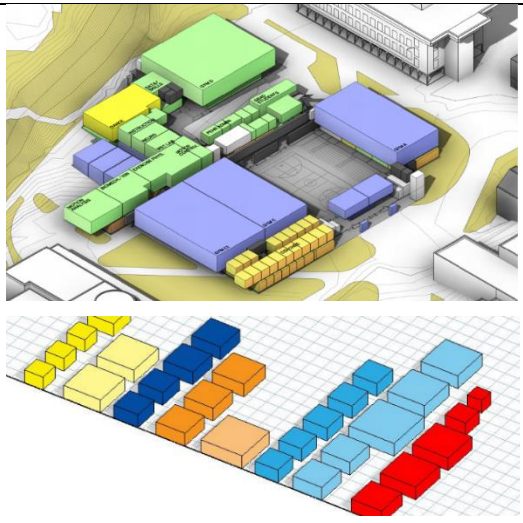
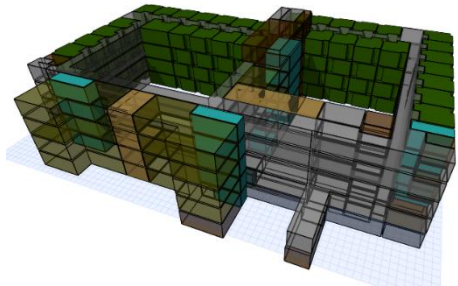
<p>100</p>	<p>Spaces are modeled as generic objects with approximate size, shape and location. This level is typically appropriate for design of spatial requirements where space objects are placed in a model either in a random manner for quantification or in a 'blocking and stacking' process.</p> <p>Bounding elements are not required, but may be needed if specific dimensions are desired.</p> <p>Element modeling to include:</p> <ul style="list-style-type: none"> • Space object based on area required by program or brief. • 	 <p>From http://revitaddons.blogspot.com/2014/02/free-space-planning-massing-from-excel.html</p>
<p>200</p>	<p>Spaces are modeled or placed with bounding elements such as walls and columns that are at a minimum of LOD200. Perimeter and area of spaces are calculated with respect to the bounding elements.</p> <p>LOD of spaces shall not exceed the LOD of the bounding elements. For example, if interior partitions are defined at LOD200, the space objects for the project cannot be delivered at LOD300.</p> <p>Element modeling to include:</p> <ul style="list-style-type: none"> • Vertical bounding elements at LOD200 • Space objects that automatically associate with vertical bounding elements 	 <p>From http://cad-3d.blogspot.com/2012/06/improve-usage-of-bim-during-early.html</p>
<p>300</p>	<p>Spaces are modeled or placed with bounding elements that are at a minimum of LOD300. Perimeter and area of spaces are calculated with respect to the bounding elements.</p> <p>Element modeling to include:</p>	



Unifomat Omniclass

	<ol style="list-style-type: none"> 1) Vertical bounding elements at LOD300 2) Space objects that automatically associate with vertical bounding elements 	
350	<p><i>Comply with the LOD300 requirements.</i></p> <p>Volume of the space is accurately calculated to the nearest horizontal finish surface such as a ceiling or underside of slab above.</p> <p>Element modeling to include:</p> <ol style="list-style-type: none"> 1) Vertical bounding elements to minimum LOD300 2) Horizontal bounding elements such as ceilings or slabs 3) Space objects that automatically associate with vertical and horizontal bounding elements 	

N/A

36-51 73 11 13 17 11

Horizontal Grids

See [Vertical Levels](#)

N/A

36-51 73 11 13 17 13

Vertical Levels

Includes: Grids and elevations used to coordinate and annotate models.

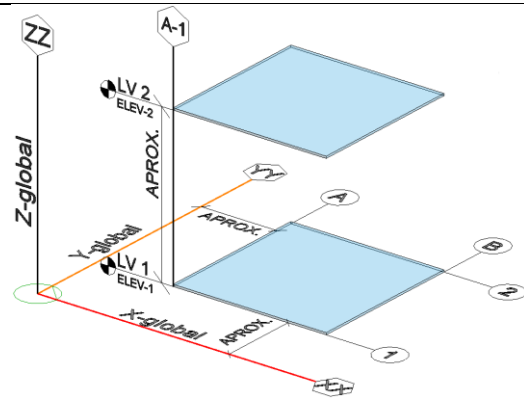
100		
200	<p>Grids & Elevations</p> <p>Equipment, Building, Campus, Civil, and GIS is approximate in its relation to the content in the given model.</p>	 <p><i>LOD 200 Grids & Elevations From AscendBKF.org</i></p>

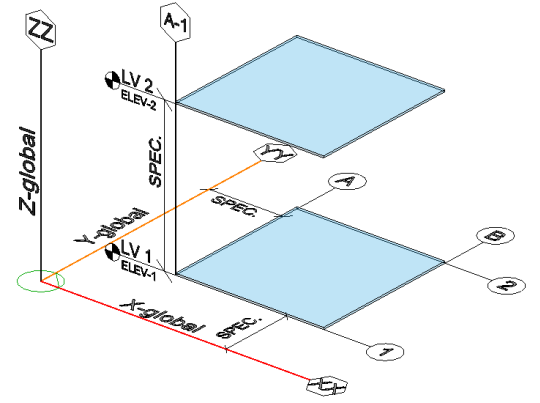

Unifomat Omniclass

300	<p>Grids & Elevations</p> <p>Equipment, Building, Campus, Civil, and GIS is <i>specific</i> in its relation to the content in the given model.</p>	 <p>The diagram illustrates a 3D coordinate system with three axes: Z-global (vertical), Y-global (depth), and X-global (width). Two horizontal planes are shown, representing Level 1 (LV 1) and Level 2 (LV 2). The Z-axis is labeled 'Z-global' and has a 'Z' symbol at the top. The Y-axis is labeled 'Y-global' and the X-axis is labeled 'X-global'. The top plane is labeled 'LV 2 ELEV. 2' and the bottom plane is labeled 'LV 1 ELEV. 1'. Grid lines are shown as dashed lines on both planes, with labels 'A-1' and 'A' for vertical grid lines, and '1' and '2' for horizontal grid lines. The vertical distance between the two planes is labeled 'SPEC.'. The diagram also shows a 'Z' symbol at the origin and a 'Y' symbol at the end of the Y-axis.</p> <p>LOD 300 Grids & Elevations From AscendBKF.org</p>
-----	--	---



Unifomat Omniclass

A 21-01 SUBSTRUCTURE

Associated Masterformat Sections: 01 82 00

A10 21-01 10 Foundations

Associated Masterformat Sections: 01 82 13

100	Assumptions for foundations are included in other modeled elements such as an architectural floor element or volumetric mass that contains layer for assumed structural framing depth. Or, schematic elements that are not distinguishable by type or material. Assembly depth/thickness and locations still flexible.	
200	Element modeling to include: <ul style="list-style-type: none"> • Approximate size and shape of foundation element • Structural building grids for local project coordinate system are defined in model and approximately coordinated with civil coordinate . 	

A1010 21-01 10 10 Standard Foundations

Includes: Formwork, concrete, masonry and reinforcement. Includes Standard Foundation Supplementary Components as appropriate. May Include: Related Activities: Excavation, dewatering, excavation support systems, backfill and compaction, and soil treatment.

Note – for formwork see [Structural Concrete Products](#)

Associated Masterformat Sections: 01 82 13

100	See A10	
200	See A10	
300	Elements are modeled to the design-specified size and shape of the foundation. Element modeling to include: <ul style="list-style-type: none"> • Overall size and geometry of the foundation element • Sloping surfaces or floor depressions • External dimensions of the members • Main openings such as elevators and other shafts 	



Unifomat Omniclass

A1010.10 21-01 10 10 10 Wall Foundations (Shallow Foundations)

Associated Masterformat Sections: 03 30 00 / 03 40 00 / 04 20 00 / 06 14 00

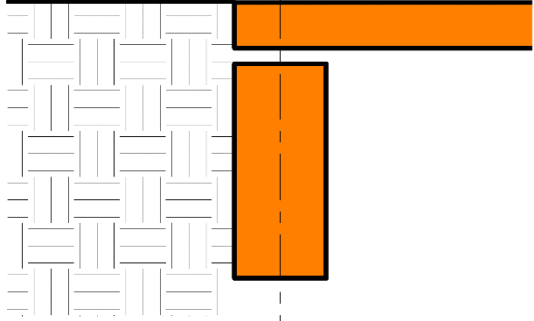
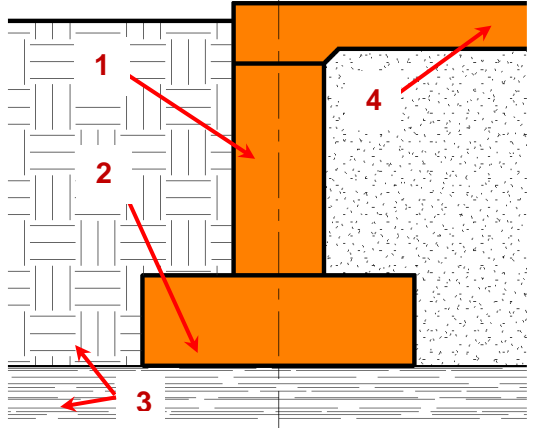
100	See A10	
200	<p>See A10</p> <p><i>Image Notes:</i></p> <ul style="list-style-type: none"> • <i>Generic wall foundation is modeled.</i> • <i>Site is generically modeled from geotechnical information in geotechnical report.</i> 	 <p>From lkerd.com</p>
300	<p>Element modeling to include:</p> <ol style="list-style-type: none"> 1) Overall size and geometry of the foundation element 2) Sloping surfaces. 3) External dimensions of the members 4) Geotechnical bearing strata elevation is modeled from geotechnical report. 5) Area of bearing influence – modeled or accommodated by model checking software <p><i>Image Notes:</i></p> <ol style="list-style-type: none"> 6) <i>Wall foundation sizes are accurately modeled with footings where applicable.</i> 7) <i>Bearing elevation is modeled from the geotechnical report.</i> 8) <i>Geotechnical regions are shown for context and not required to be modeled as part of this element at this LOD.</i> 9) <i>See slab on grade for related conditions at this LOD.</i> 	 <p>1 A1010.10-LOD-300 Wall Foundation From lkerd.com</p>

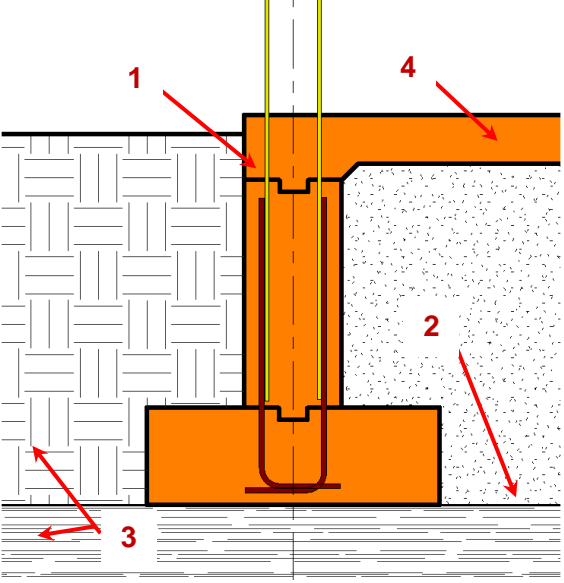

Unifomat Omniclass

<p>350</p>	<p>Element modeling to include:</p> <ol style="list-style-type: none"> 1) Location of sleeve penetrations 2) Pour joints 3) Chamfer 4) Moisture retarder 5) Dowels 6) All exposed embeds or reinforcement such as lintels 7) Expansion joints 8) Geotechnical Bearing Strata is modeled from geotechnical report estimates. <p><i>Image Notes:</i></p> <p>9) <i>Grade beam sizes are modeled with interfaces to other systems such as but not limited to slab turn downs, key-ways between concrete pours, construction joints and reinforcing dowels into adjacent pours.</i></p> <p>10) <i>Bearing elevation is modeled from the geotechnical report with the addition on interface elements such as void boxes where applicable.</i></p> <p>11) <i>Geotechnical regions are shown for context and not required to be modeled as part of this element at this LOD.</i></p> <p>12) <i>See slab on grade for related conditions at this LOD.</i></p>	 <p>2 A1010.10-LOD-350 Wall Foundations (Shallow Foundations), From lkerd.com</p>
<p>400</p>	<p>Element modeling to include:</p> <ul style="list-style-type: none"> • Rebar including hooks and lap splices • Dowels • Coursing for unit masonry defined • Waterproofing 	

A1010.30 21-01 10 10 30 Column Foundations (Deep Foundations)

Associated Masterformat Sections: 03 30 00

<p>100</p>	<p>See A10</p>	
<p>200</p>	<p>See A10</p>	

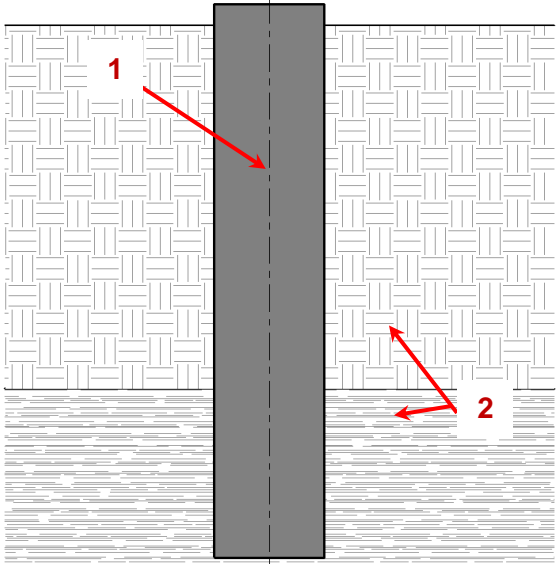

Unifomat Omniclass

300	<p>Element modeling to include:</p> <ol style="list-style-type: none">1) Assumed bearing depth per geotechnical report with designed penetration geometry modeled.2) Top of Pier3) Size of Pier4) Area of bearing influence - modeled or accommodated by model checking software <p><i>Image Notes:</i></p> <ol style="list-style-type: none">5) Pier sizes are accurately modeled with top of pier elevation, estimated depth to bearing and specified depth of penetration into bearing strata.6) Geotechnical regions are shown for context and not required to be modeled as part of this element at this LOD.	 <p>3 A1010.30-LOD-300 Column Foundations (Deep Foundations), From lkerd.com</p>
-----	--	---

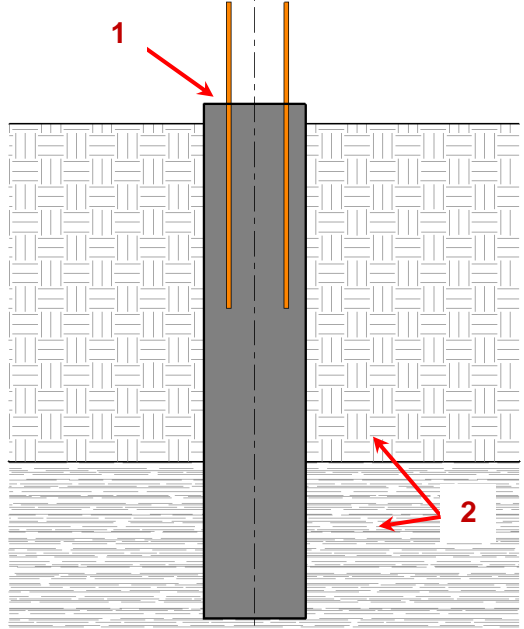

Unifomat Omniclass

<p>350</p>	<p>Element modeling to include:</p> <ul style="list-style-type: none">• Actual Top of Pier (TOP) and expected Bottom of Pier (BOT) modeled per engineer's review of site conditions• Foundation dowel locations and anchor rods if applicable. <p><i>Image Notes:</i></p> <ol style="list-style-type: none">1. Pier sizes are accurately modeled with interfaces to other systems such as but not limited to slab turn downs, key-ways between concrete pours, construction joints and reinforcing dowels into adjacent pours.2. Geotechnical regions are shown for context and not required to be modeled as part of this element at this LOD.	 <p>The diagram shows a vertical column foundation. A red arrow labeled '1' points to the top surface of the column. A red arrow labeled '2' points to the interface between the column and the surrounding geotechnical region, which is depicted with a brick-like pattern. Below the column, there are horizontal lines representing a different material or layer. Below the diagram, there is a 3D perspective view of the column with several vertical rods extending from its top.</p> <p>4 A1010.30-LOD-350 Column Foundations, From lkerd.com</p>
------------	---	---

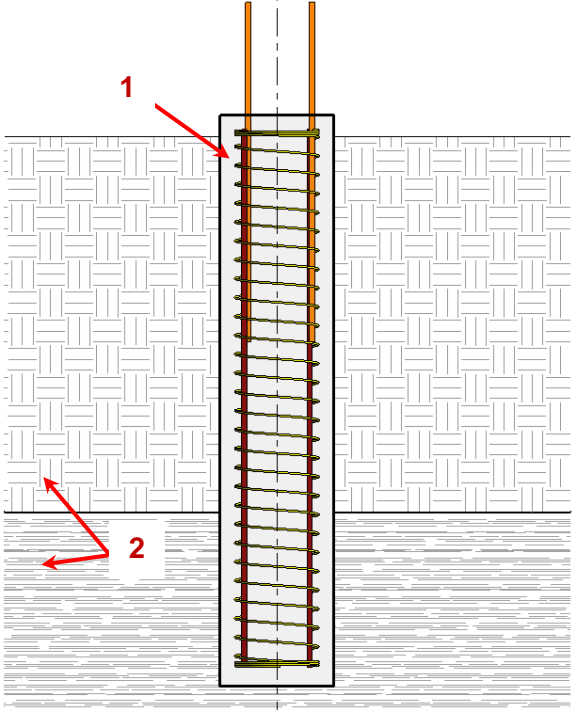

Unifomat Omniclass

400	<p>Element modeling to include:</p> <ul style="list-style-type: none">• Depth to bearing stratum• Penetration into bearing stratum• Locations of lap splices• Rebar including hooks and lap splices• Dowels• Pier sled or Pier wheel for side clear cover• Pier bolster for bottom clear cover <p><i>Image Notes:</i></p> <ol style="list-style-type: none">1. Pier modeling is developed to include all fabrication content that is part of the element.2. Geotechnical regions are shown for context and not required to be modeled as part of this element at this LOD.3. Pier sled, pier wheel, pier bolsters and other related items are not shown in image for clarity.	 <p>The diagram illustrates a vertical pier with a rebar cage. The pier is shown in a cross-section, with the rebar cage highlighted in a darker color. The pier is surrounded by a geotechnical region, which is shown with a pattern of horizontal and vertical lines. Two red arrows point to specific features: arrow 1 points to the top of the pier, and arrow 2 points to the bottom of the pier. The diagram is labeled 'From lkerd.com' at the bottom.</p>
-----	---	--

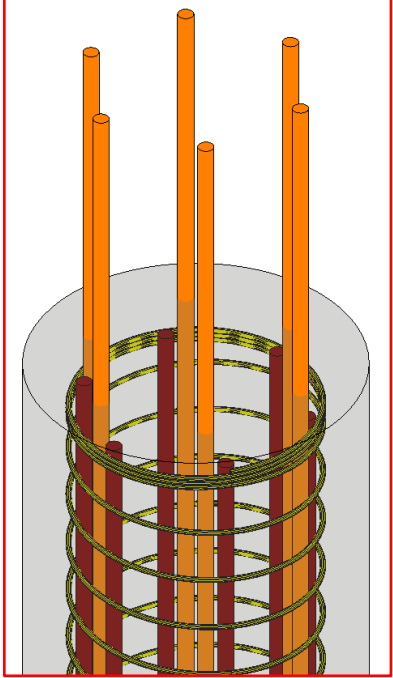

Unifomat Omniclass

		 <p data-bbox="906 989 1365 1045">5 A1010.30-LOD-400 Column Foundations From lkerd.com</p>
--	--	--

A1010.90 21-01 10 10 90 Standard Foundation Supplementary Components TBD

A1020 21-01 10 20 Special Foundations

Includes: Drilling, casing, bell bottom, excavation, dewatering, removal of excavated, materials, reinforcing, and concrete. Drilled Piers, Driven Piles, Mat Foundation, elevator pits.

Associated Masterformat Sections: 31 60 00

100	See A10	
200	See A10	
300	See A1010 1) Elevator pit slabs are sloped correctly 2) Sump pits are shown at correct locations and geometries	



Unifomat Omniclass

350	<p>Element modeling to include:</p> <ul style="list-style-type: none"> • Location and size of sleeve penetrations and MEP openings • Chamfer • Pour joints • Dowels • All elements needed for cross-trade collaboration are to be modeled • Actual location and shape of structural element • Exposed embeds or reinforcement such as lintels • Penetrations detailed and modeled • Expansion joints 	
400	<p>Element modeling to include:</p> <ul style="list-style-type: none"> • Rebar detailing including hooks and lap splices • Dowels • Moisture retarder • Coursing for unit masonry defined • Waterproofing 	

A1020.10

21-01 10 20 20

Driven Piles

TBD

Includes: Piles, pile driving, pile cut off, pile testing.





Unifomat Omniclass

A1020.10.10 21-01 10 20 20

Helical Piles, Helical Piers

Associated Masterformat Sections: N/A

100	See A10	
200	See A10 Helical Pile	 <p><i>A1020.10.10 LOD 200 Helical Piers From AscendBKF.org</i></p>
300	<p>Element modeling to include:</p> <ul style="list-style-type: none"> • Pile system type • Pile material • Coating • Influence area modeled or accommodated by model checking software 	 <p><i>A1020.10.10 LOD 300 Helical Piers From AscendBKF.org</i></p>

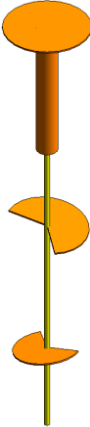
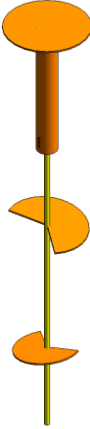

Uniformat Omniclass

350	<p>Element modeling to include:</p> <ul style="list-style-type: none"> • Spacing • Plate Size • Bearing Strata 	 <p><i>A1020.10.10 LOD 350 Helical Piers From AscendBKF.org</i></p>
400	<p>Element modeling to include:</p> <ul style="list-style-type: none"> • Full fabrication connections 	 <p><i>A1020.10.10 LOD 400 Helical Piers From AscendBKF.org</i></p>

A1020.20	21-01 10 20 20	Caissons	TBD
A1020.30	21-01 10 20 30	Special Foundation Walls	TBD
A1020.40	21-01 10 20 40	Foundation Anchors	TBD



Unifomat Omniclass

A1020.50	21-01 10 20 50	Underpinning	TBD
A1020.60	21-01 10 20 60	Raft Foundations	TBD
A1020.70	21-01 10 20 70	Pile Caps	TBD
A1020.80	21-01 10 20 80	Grade Beams	

Includes: Formwork, reinforcement, and concrete.

Associated Masterformat Sections: 03 30 00

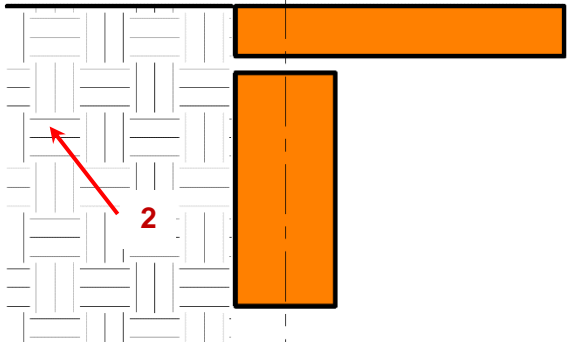
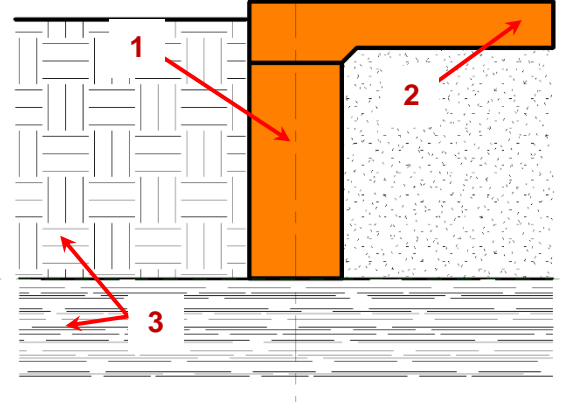
100	See A10	
200	See A10 <i>Image Notes:</i> <ul style="list-style-type: none"> • <i>Generic beam geometry is shown.</i> • <i>Geotechnical regions are shown for context and not required to be modeled as part of this element at this LOD.</i> 	 <p>6 A1020.80-LOD-200 Grade Beams, From lkerd.com</p>
300	See A1010 <i>Image Notes:</i> <ol style="list-style-type: none"> 1) <i>Grade Beam</i> 2) <i>See slab on grade (A4010, A4020) for related conditions at this LOD.</i> 1) <i>Geotechnical regions are shown for context and not required to be modeled as part of this element at this LOD.</i> 	 <p>7 A1020.80-LOD-300 Grade Beams, From lkerd.com</p>

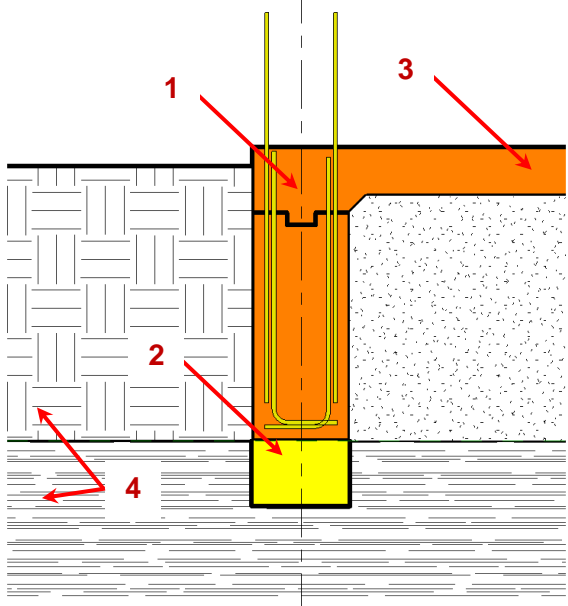

Unifomat Omniclass

<p>350</p>	<p>Element modeling to include:</p> <ul style="list-style-type: none"> • Water stops • Pour joints and sequences required to identify reinforcing lap splice, scheduling, etc. • Chamfer <p><i>Image Notes:</i></p> <ul style="list-style-type: none"> • <i>Grade beam sizes are modeled with interfaces to other systems such as but not limited to slab turn downs, key-ways between concrete pours, construction joints and reinforcing dowels into adjacent pours.</i> • <i>Interface elements such as void boxes or critical bearing zones are modeled where applicable.</i> • <i>See slab on grade ((A4010, A4020) for related conditions at this LOD.</i> • <i>Geotechnical regions are shown for context and not required to be modeled as part of this element at this LOD.</i> 	 <p>8 A1020.80-LOD-350 Grade Beams, From lkerd.com</p>
<p>400</p>	<p>Element modeling to include:</p> <ul style="list-style-type: none"> • Detailed post-tensioned components • Rebar including hooks and lap splices • Dowels • Waterproofing 	

A20 21-01 20 Subgrade Enclosures

Associated Masterformat Sections: 01 82 16

<p>100</p>	<p>Solid mass model representing overall building volume; or, schematic wall elements that are not distinguishable by type or material.</p> <p>Assembly depth/thickness and locations still flexible.</p>	
<p>200</p>	<p>Element modeling to include:</p> <ul style="list-style-type: none"> • Approximate size and shape of the subgrade enclosure element. • Structural building grids for local project coordinate system are defined in model and coordinated with global civil coordinate system (State Plane Coordinate System, etc). 	



Uniformat Omniclass

	Suggested Baseline Attributes 1) Member Type	
--	---	--

A2010 21-01 20 10 Walls for Subgrade Enclosures

Includes: Perimeter walls enclosing building space below grade. Includes formwork, reinforcing, concrete and masonry. Includes Subgrade Enclosure Wall Supplementary Components as appropriate. May Include: Related Activities: Excavation, dewatering, excavation support systems, backfill and compaction, and soil treatment.

Associated Masterformat Sections: 01 82 16

100	See A20	
200	See A20	
300	Element modeling to include: <ul style="list-style-type: none"> Overall size and geometry of the subgrade element Sloping surfaces External dimensions of the element Major openings such as large mechanical elements modeled to nominal dimensions. 	
350	Element modeling to include: <ul style="list-style-type: none"> Chamfers All penetrations modeled to rough opening dimensions. Pour joints Rebar and any embedded elements modeled at congested areas where specified by project BXP which is typically within a set distance from the area of congestion. Any permanent shoring or forming structures such as void boxes insulation Expansion joints Moisture retarder Exposed embeds or reinforcement such as lintels Penetrations detailed and modeled Expansion joints 	
400	Element modeling to include: <ul style="list-style-type: none"> Rebar including hooks and lap splices Dowels Coursing for unit masonry defined Waterproofing 	



Unifomat Omniclass

A2010.10	21-01 20 10 10	Subgrade Enclosure Wall Construction	TBD
A2010.20	21-01 20 10 20	Subgrade Enclosure Wall Interior Skin	TBD
A2010.90	21-01 20 10 90 TBD	Subgrade Enclosure Wall Supplementary Components	

A40 21-01 40 Slabs-on-Grade

Associated Masterformat Sections: 01 82 00

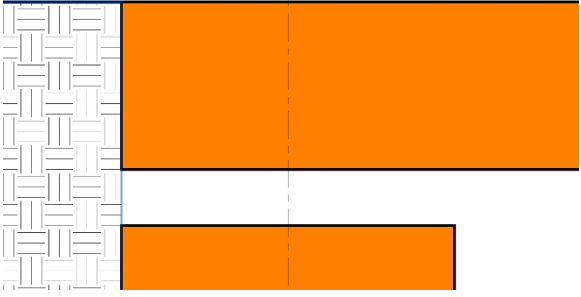
100	Assumptions for slabs are included in other modeled elements such as a volumetric mass or architectural floor element that contains a layer for assumed structural framing depth.	
200	<p>Element modeling to include</p> <ul style="list-style-type: none"> • Generic slab with approximate thickness. • Structural building grids for local project coordinate system are defined in model and coordinated with global civil coordinate system (State Plane Coordinate System, etc.) 	 <p>9 A40-LOD-200 Slabs-on-Grade From lkerd.com</p>

A4010 21-01 40 10 Standard Slabs-on-Grade

Includes: Slab construction supported continuously by earth or compacted fill. Includes fine grading, subbase layer, mud slab, insulation, vapor retarder, waterproofing, formwork, expansion joints, control joints, reinforcement, concrete, and finishing includes: Slabs-On-Grade Supplementary Components as appropriate. May Include: Related Activities: Excavation, dewatering, excavation support systems, backfill and compaction, and soil treatment.

Associated Masterformat Sections: 03 30 00

100	See A40	
200	See A40	

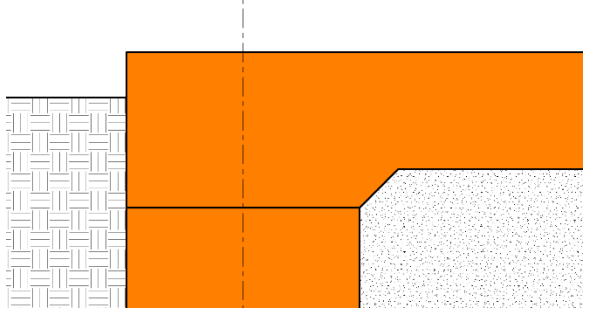
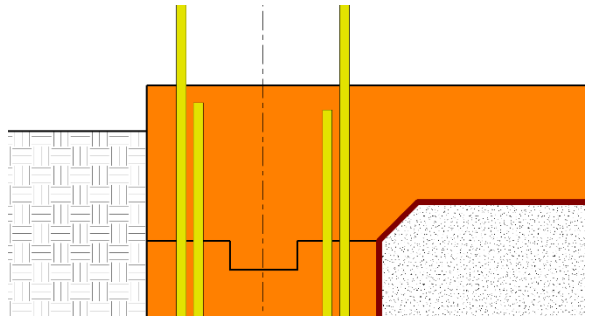

Unifomat Omniclass

<p>300</p>	<p>Element modeling to include:</p> <ul style="list-style-type: none"> • Overall size, thickness and geometry of the slab • Major openings such as large mechanical elements modeled to nominal dimensions. • Slab depressions • Edge turn downs • Material strength • Surfaces modeled to actual slopes 	 <p>10 A4010-LOD-300 Standard Slabs-on-Grade From lkerd.com</p>
<p>350</p>	<p>Element modeling to include:</p> <ul style="list-style-type: none"> • All penetrations modeled to rough opening dimensions. • Pour joints • Control joints • Expansion joints • Water stops • Rebar and any embedded elements modeled at congested areas where specified by project BIMXP which is typically with in a set distance from the area of congestion. • Void boxes • Anchor rods • Dowels • Post-tension profile and strands if required by the BXP. 	 <p>11 A4010-LOD-350 Standard Slabs-on-Grade From lkerd.com</p>
<p>400</p>	<p>Element modeling to include:</p> <ul style="list-style-type: none"> • Fully modeled rebar • Actual slab dimensions and profiles with fully modeled rebar • Post tensioning components • All joints • Water proofing • Finish 	

A4020 21-01 40 20 Structural Slabs-on-Grade

Includes: Self-supporting slab construction not supported continuously by earth or compacted fill. Includes formwork, accessories, reinforcement, concrete, and finishing. Includes Slabs-On-Grade Supplementary Components as appropriate. May Include: Related Activities: Excavation, dewatering, excavation support systems, backfill and compaction, and soil treatment.

Associated Masterformat Sections: 03 30 00

<p>100</p>	<p>See A40</p>	
------------	--------------------------------	--

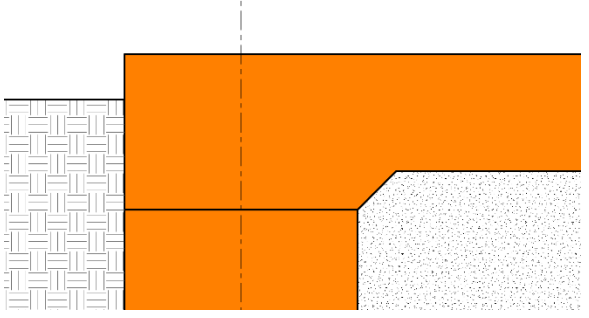
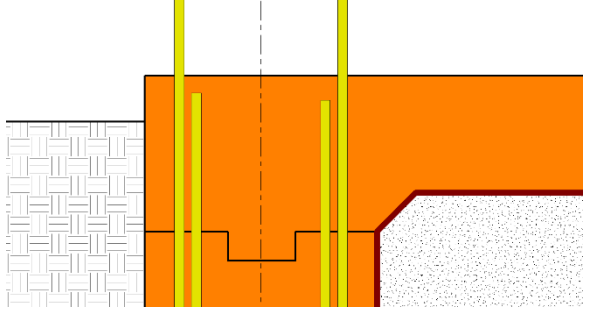

Unifomat Omniclass

200	See A40	
300	<p>Element modeling to include:</p> <ul style="list-style-type: none"> • Overall size, thickness and geometry of the slab-on-grade • Major openings such as large mechanical elements modeled to nominal dimensions. • Slab depressions • Edge turn downs • All sloping surfaces included in model element with exception of elements affected by manufacturer selection which are not known at this LOD. Such conditions could include floor geometry differences where different <u>specified</u> manufacturers will not be known until the <u>actual</u> system is selected. 	 <p><i>12 A4020-LOD-300 Structural Slabs-on-Grade From lkerd.com</i></p>
350	<p>Element modeling to include:</p> <ul style="list-style-type: none"> • All penetrations modeled to rough opening dimensions. • Pour joints • Control joints • Expansion joints • Water Stops • Rebar and any embedded elements modeled at congested areas where specified by project BXP which is typically within a set distance from the area of congestion. • Void boxes • Anchor rods • Moisture retarder • Dowels • Post-tension profile and strands modeled if required by the BXP 	 <p><i>13 A4020-LOD-350 Structural Slabs-on-Grade From lkerd.com</i></p>
400	<p>Element modeling to include:</p> <ul style="list-style-type: none"> • Fully modeled rebar • Actual slab dimensions and profiles with fully modeled rebar • Post tensioning components • All joints • Water proofing • Finish 	

A4030	21-01-40-30	Slab Trenches	TBD
A4040	21-01-40-40	Pits and Bases	TBD



Unifomat	Omniclass		
A4090	21-01-40-90	Slab-On-Grade Supplementary Components	TBD
A60	21-01-60	Water and Gas Mitigation	TBD
A6010	21-01-60-10	Building Subdrainage	TBD
A6020	21-01-60-20	Off-Gassing Mitigation	TBD
A90	21-01-90	Substructure Related Activities	TBD
A9010	21-01-90-10	Substructure Excavation	TBD
A9020	21-01-90-20	Construction Dewatering	TBD
A9030	21-01-90-30	Excavation Support	TBD
A9040	21-01-90-40	Soil Treatment	TBD



Unifomat Omniclass

B 21-02 00 00 SHELL

Associated Masterformat Sections: 01 83 00

B10 21-02 10 Superstructure

Associated Masterformat Sections: 01 83 13

100	<p>Assumptions for structural framing are included in other modeled elements such as an architectural floor element that contains a layer for assumed structural framing depth or schematic structural elements that are not distinguishable by type or material.</p> <p>Assembly depth/thickness or component size and locations still flexible.</p>	
-----	---	--

B1010 21-02 10 10 Floor Construction

Associated Masterformat Sections: 01 83 13

100	See B10	
200	<p>Model elements to include:</p> <ul style="list-style-type: none"> • Floor with approximate dimensions • Approximate supporting framing members • Structural grids defined accurately 	

B1010.10 21-02 10 10 10 Floor Structural Frame

Includes: Structural elements required for support of floor construction within basements and above grade. Includes columns, girders, beams, trusses, joists. Includes cast-in-place concrete, precast concrete, unit masonry, metal framed, and wood framed systems. Includes framed and sleeved openings for services. Includes Floor Construction Supplementary Components as appropriate.

Specific structural systems within this section are listed as follows:

- Concrete [B1010.10.10](#)
- Precast Structural Inverted T Beam [B1010.10.11](#)
- Precast Structural Column [B1010.10.12](#)
- Masonry [B1010.10.20](#)
- Steel Framing Columns [B1010.10.30](#)
- Steel Framing Beams [B1010.10.40](#)
- Steel Framing Bracing Rods [B1010.10.50](#)
- Steel Joists [B1010.10.60](#)
- Cold-Formed Metal Framing [B1010.10.70](#)
- Wood Floor Trusses [B1010.10.80](#)

Associated Masterformat Sections: 03 30 00 / 03 40 00 / 04 20 00 / 05 10 00 / 05 20 00
05 21 23 / 05 42 00 / 05 44 00 / 06 11 00 / 06 13 00 / 06 13 26 / 06 17 33 / 06 17 36
06 17 53 / 06 18 13 / 06 18 16 / 06 50 00



Unifomat Omniclass

B1010.10.10 21-02 10 10 10 10 Floor Structural Frame (Concrete)

Associated Masterformat Sections: 03 30 00 / 03 40 00

100	See B10	
200	Element modeling to include: <ul style="list-style-type: none"> Type of structural concrete system Approximate geometry (e.g. depth) of structural elements 	
300	Element modeling to include: <ol style="list-style-type: none"> Composite model assembly by type with overall thickness of structural frame <ul style="list-style-type: none"> Specific sizes and locations of main concrete structural members modeled per defined structural grid with correct orientation Concrete defined per spec (strength, air entrainment, aggregate size, etc.) All sloping surfaces included in model element with exception of elements affected by manufacturer selection 	
350	Element modeling to include: <ul style="list-style-type: none"> Reinforcing Post-tension profiles and strand locations Reinforcement called out, modeled if required by the BXP, typically only in congested areas Pour joints and sequences to help identify reinforcing lap splice locations, scheduling, etc. Expansion Joints Embeds and anchor rods Post-tension profile and strands modeled if required by the BXP Penetrations for items such as MEP Any permanent forming or shoring components Shear reinforcing and stud rails Critical structural zones for coordination, including but not limited to zones that cannot be penetrated, cut, or damaged Chamfer 	
400	Element modeling to include: <ul style="list-style-type: none"> All reinforcement including post tension elements detailed and modeled camber, etc. 	



Unifomat Omniclass

B1010.10.11 21-02 10 10 10 11 Precast Structural Inverted T Beam (Concrete)

Includes: Structural elements required for support of floor construction within basements and above grade. Includes columns, girders, beams, trusses, joists. Includes cast-in-place concrete, precast concrete, unit masonry, metal framed, and wood framed systems. Includes framed and sleeved openings for services. Includes Floor Construction Supplementary Components as appropriate.

Associated Masterformat Sections: 03 30 00 / 03 40 00 / 04 20 00 / 05 10 00 / 05 20 00
05 21 23 / 05 42 00 / 05 44 00 / 06 11 00 / 06 13 00 / 06 13 26 / 06 17 33 / 06 17 36
06 17 53 / 06 18 13 / 06 18 16 / 06 50 00

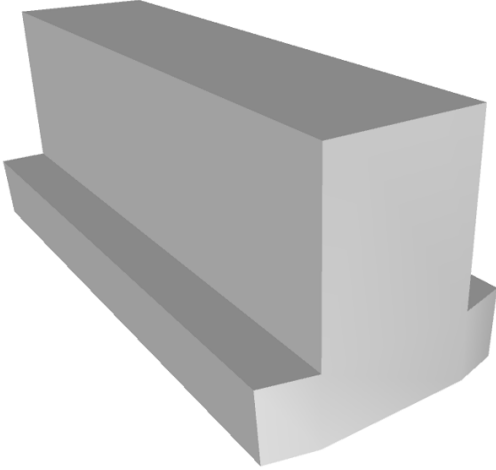
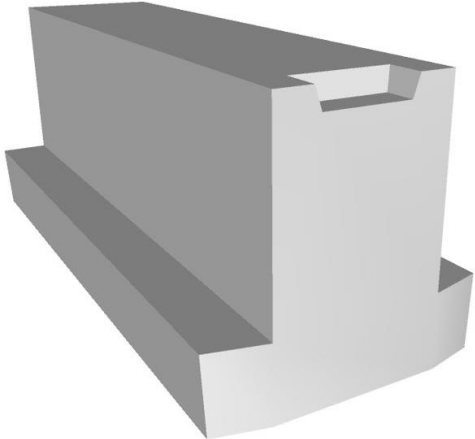
100	See B10	
200	<p>Element modeling to include:</p> <ul style="list-style-type: none"> Type of structural concrete system Approximate geometry (e.g. depth) of structural elements 	 <p>14 B1010.10-LOD 200 Precast Structural Inverted T Beam (Concrete), From lkerd.com</p>
300	<p>Element modeling to include:</p> <ul style="list-style-type: none"> Specific sizes and locations of main concrete structural members modeled per defined structural grid with correct orientation All sloping surfaces included in model element with exception of elements affected by manufacturer selection 	 <p>15 B1010.10-LOD 300 Precast Structural Inverted T Beam (Concrete), From lkerd.com</p>

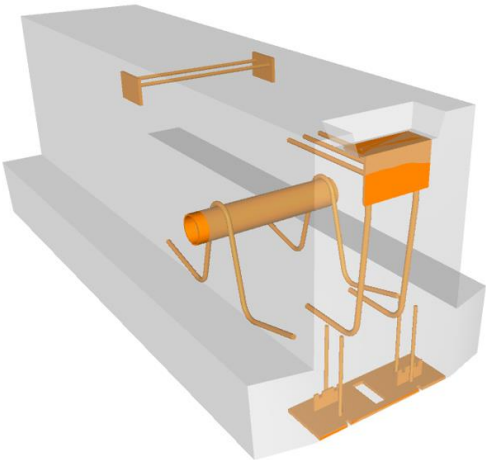
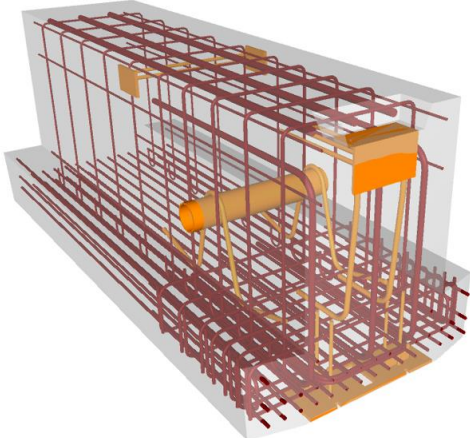

Unifomat Omniclass

<p>350</p>	<p>Element modeling to include:</p> <ul style="list-style-type: none"> • Reinforcing Post-tension profiles and strand locations • Reinforcement called out, modeled if required by the BXP, typically only in congested areas • Chamfer • Pour joints and sequences to help identify reinforcing lap splice locations, scheduling, etc. • Lifting devices • Expansion Joints • Embeds and anchor rods • Post-tension profile and strands modeled if required by the BXP • Penetrations for items such as MEP • Any permanent forming or shoring components 	 <p>16 B1010.10-LOD 350 Precast Structural Inverted T Beam (Concrete), From lkerd.com</p>
<p>400</p>	<p>Element modeling to include:</p> <ul style="list-style-type: none"> • All reinforcement including post tension elements detailed and modeled • Finishes 	 <p>17 B1010.10-LOD 400 Precast Structural Inverted T Beam (Concrete), From lkerd.com</p>



Unifomat Omniclass

B1010.10.12 21-02 10 10 10 12 Precast Structural Column (Concrete)

Includes: Structural elements required for support of floor construction within basements and above grade. Includes columns, girders, beams, trusses, joists. Includes cast-in-place concrete, precast concrete, unit masonry, metal framed, and wood framed systems. Includes framed and sleeved openings for services. Includes Floor Construction Supplementary Components as appropriate.

Associated Masterformat Sections: 03 30 00 / 03 40 00 / 04 20 00 / 05 10 00 / 05 20 00
05 21 23 / 05 42 00 / 05 44 00 / 06 11 00 / 06 13 00 / 06 13 26 / 06 17 33 / 06 17 36
06 17 53 / 06 18 13 / 06 18 16 / 06 50 00

100	See B10	
200	<p>Element modeling to include:</p> <ul style="list-style-type: none"> • Type of structural concrete system • Approximate geometry (e.g. depth) of structural elements 	 <p>18 B1010.10- LOD 200 Precast Structural Column (Concrete), From lkerd.com</p>



Unifomat Omniclass

300	<p>Element modeling to include:</p> <ul style="list-style-type: none">• Specific sizes and locations of main concrete structural members modeled per defined structural grid with correct orientation• All sloping surfaces included in model element with exception of elements affected by manufacturer selection	 <p>19 B1010.10 - LOD 300 Precast Structural Column (Concrete), From lkerd.com</p>
-----	--	--

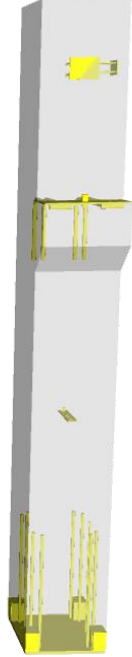

Uniformat Omniclass

350	<p>Element modeling to include:</p> <ul style="list-style-type: none">• Reinforcing Post-tension profiles and strand locations• Reinforcement called out, modeled if required by the BXP, typically only in congested areas• Chamfer• Pour joints and sequences to help identify reinforcing lap splice locations, scheduling, etc.• Expansion Joints• Lifting devices• Embeds and anchor rods• Post-tension profile and strands modeled if required by the BXP• Penetrations for items such as MEP• Any permanent forming or shoring components	 <p>20 B1010.10 - LOD 350 Precast Structural Column (Concrete), From lkerd.com</p>
-----	---	--



Unifomat Omniclass

400	<p>Element modeling to include:</p> <ul style="list-style-type: none"> All reinforcement including post tension elements detailed and modeled Finishes 	 <p>21 B1010.10 - LOD 400 Precast Structural Column (Concrete), From lkerd.com</p>
-----	--	--

B1010.10.20 21-02 10 10 10 20 Floor Structural Frame (Masonry)

Associated Masterformat Sections: 04 20 00

100	See B10	
200	<p>Element modeling to include:</p> <ul style="list-style-type: none"> Type of structural masonry system 	
300	<p>Element modeling to include:</p> <ul style="list-style-type: none"> Specific sizes of main structural elements modeled per defined structural grid with correct dimensions Rough openings with reinforcement and lintels called out Penetrations for items such as MEP 	
350	<p>Element modeling to include:</p> <ul style="list-style-type: none"> Actual location and shape of structural masonry element All exposed embeds or reinforcement such as lintels All penetrations modeled to rough opening dimensions Expansion joints Grouted cell locations 	





Unifomat Omniclass

400	Element modeling to include: <ul style="list-style-type: none"> • Waterproofing • Coursing • Reinforcing Grout 	
-----	--	--

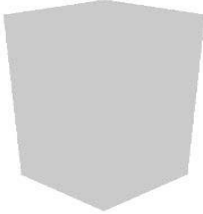
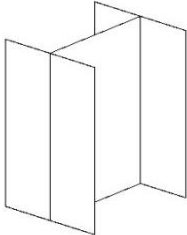

B1010.10.30 21-02 10 10 10 30 Floor Structural Frame (Steel Framing Columns)

Associated Masterformat Sections: 05 10 00

100	Generic column element, See B10 .	 <p><i>22 B1010.10-LOD-100 Floor Structural Frame (Steel Framing Columns), From lkerd.com</i></p>
200	See B1010	 <p><i>23 B1010.10-LOD-200 Floor Structural Frame (Steel Framing Columns), From lkerd.com</i></p>
300	Element modeling to include: <ul style="list-style-type: none"> • Specific sizes of main vertical structural members modeled per defined structural grid with correct location and orientation 	 <p><i>24 B1010.10-LOD-300 Floor Structural Frame (Steel Framing Columns). From lkerd.com</i></p>

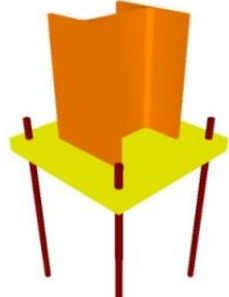

Unifomat Omniclass

<p>350</p>	<p>Element modeling to include:</p> <ul style="list-style-type: none"> • Actual elevations and location of member connections • Main elements of typical connections applied to all structural steel connections such as base plates, gusset plates, anchor rods, etc. • Any miscellaneous steel members with correct size, shape, orientation, and material. • Any steel structure reinforcement such as web stiffeners, sleeve penetrations, etc. 	 <p>25 B1010.10-LOD-350 Floor Structural Frame (Steel Framing Columns) From lkerd.com</p>
<p>400</p>	<p>Element modeling to include:</p> <ul style="list-style-type: none"> • Welds • Coping of members • Cap pates • Washers, nuts, etc. • All assembly elements 	 <p>26 B1010.10-LOD-400 Floor Structural Frame (Steel Framing Columns), From lkerd.com</p>



Unifomat Omniclass

B1010.10.40 21-02 10 10 10 40 Floor Structural Frame (Steel Framing Beams)

Associated Masterformat Sections: 05 10 00 / 05 20 00 / 05 21 23

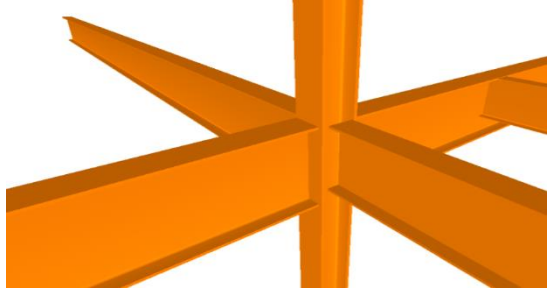
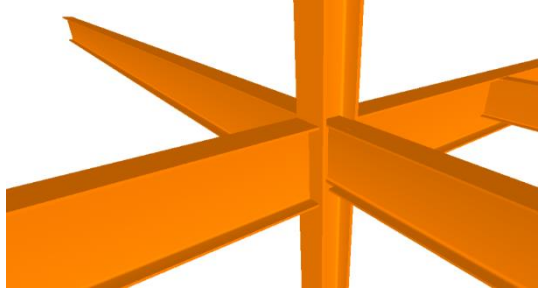
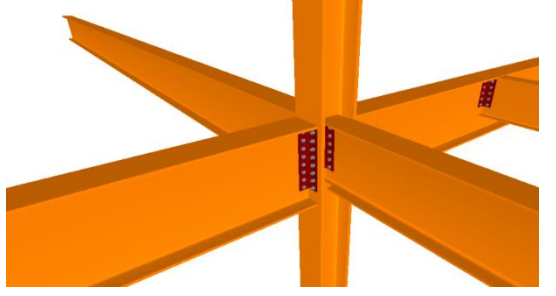
100	See B10	
200	See B1010	
300	<p>Element modeling to include:</p> <ul style="list-style-type: none"> • Specific sizes of main horizontal structural members modeled per defined structural grid with correct orientation, slope and elevation • 	 <p><i>27 B1010.10-LOD-300 Floor Structural Frame (Steel Framing Beams), From lkerd.com</i></p>
350	<p>Element modeling to include:</p> <ul style="list-style-type: none"> • Actual elevations and location of member connections • Main elements of typical connections applied to all structural steel connections such as base plates, gusset plates, anchor rods, etc. • Any miscellaneous steel members with correct size, shape, orientation and material • Any steel structure reinforcement such as web stiffeners, sleeve penetrations, etc. 	 <p><i>28 B1010.10-LOD-350 Floor Structural Frame (Steel Framing Beams), From lkerd.com</i></p>
400	<p>Element modeling to include:</p> <ul style="list-style-type: none"> • Welds • Coping of members • Bent plates, cap pates, etc. • Bolts, washers, nuts, etc. • All assembly elements 	 <p><i>29 B1010.10-LOD-400 Floor Structural Frame (Steel Framing Beams), From lkerd.com</i></p>



Unifomat Omniclass

B1010.10.50 21-02 10 10 10 50 Floor Structural Frame (Steel Framing Bracing Rods)

Associated Masterformat Sections: 05 10 00

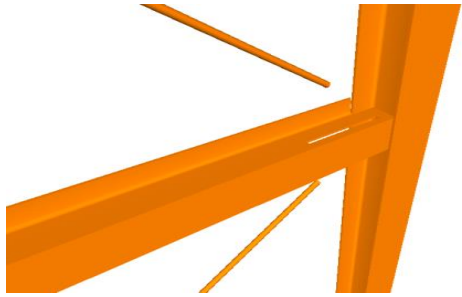
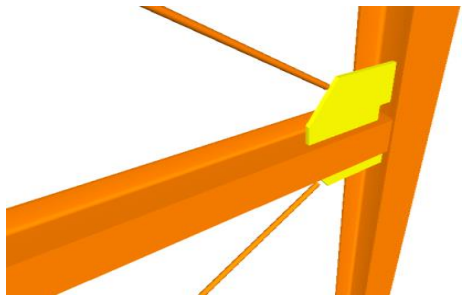
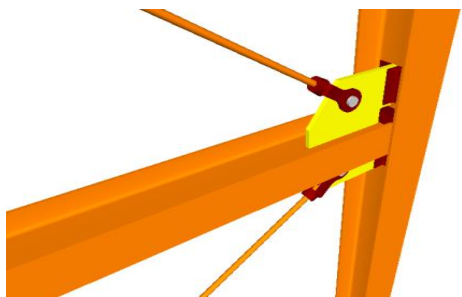
100	See B10	
200	See B1010	
300	<p>Element modeling to include:</p> <ul style="list-style-type: none"> • Specific sizes of main structural braces modeled per defined structural grid 	 <p>30 B1010.100-LOD-300 Floor Structural Frame (Steel Framing Bracing Rods), From lkerd.com</p>
350	<p>Element modeling to include:</p> <ul style="list-style-type: none"> • Connection details • Actual elevations and location of member connections • Main elements of typical connections applied to all structural steel connections such as base plates, gusset plates, anchor rods, etc. • Any miscellaneous steel members with correct size, shape, orientation and material 	 <p>31 B1010.100-LOD-350 Floor Structural Frame (Steel Framing Bracing Rods), From lkerd.com</p>
400	<p>Element modeling to include:</p> <ul style="list-style-type: none"> • Welds • Clevis • Bolts, washers, nuts, etc. • All assembly elements 	 <p>32 B1010.100-LOD-400 Floor Structural Frame (Steel Framing Bracing Rods), From lkerd.com</p>



Unifomat Omniclass

B1010.10.60 21-02 10 10 10 60 Floor Structural Frame (Steel Joists)

Associated Masterformat Sections: 05 10 00 / 05 20 00 / 05 21 23

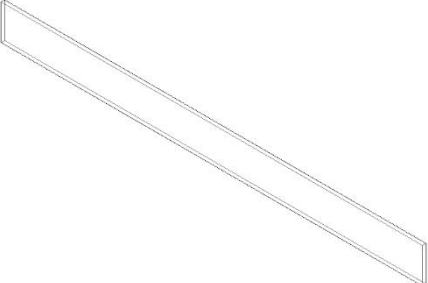
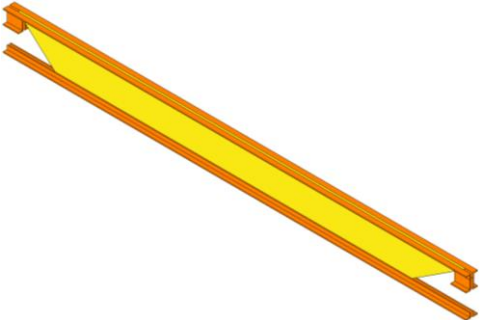
100	See B10	
200	<p>Element modeling to include:</p> <ul style="list-style-type: none"> • Approximate depth 	 <p>33 B1010.10-LOD-200 Floor Structural Frame (Steel Joists), From lkerd.com</p>
300	<p>Element modeling to include:</p> <ul style="list-style-type: none"> • Joist size, depth, slope, and material • Spacing and end elevations • Joist seat depth 	 <p>34 B1010.10-LOD-300 Floor Structural Frame (Steel Joists), From lkerd.com</p>

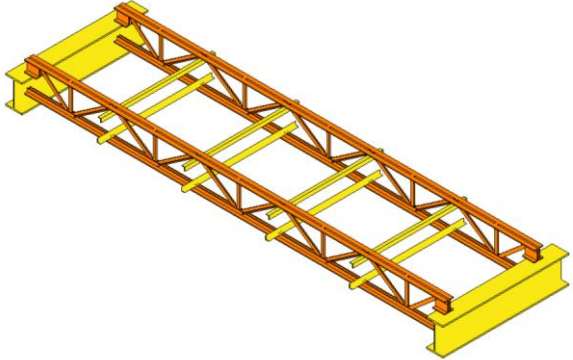
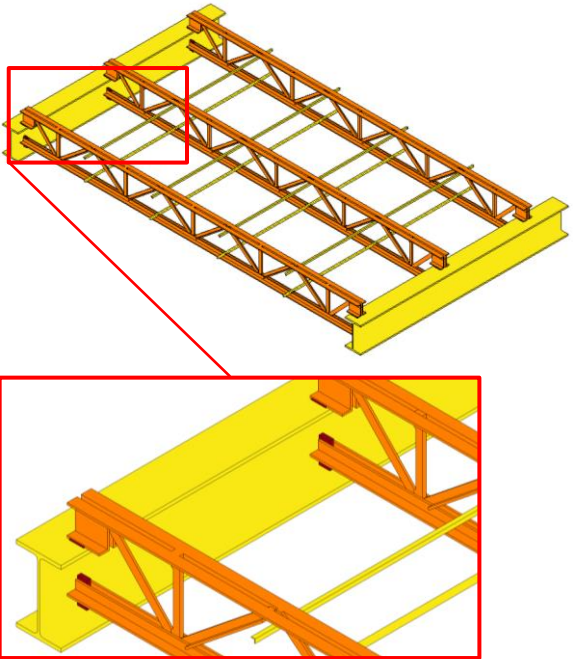

Unifomat Omniclass

<p>350</p>	<p>Element modeling to include, information needed for cross trade collaboration such as:</p> <ul style="list-style-type: none"> • Actual final joist profile locations with accurate panel points • Joist bridging and lateral braces. • Fire protection coating • Any miscellaneous steel pertaining to the joist • Joist seat width • Erection details for installation • Chord and web member section profiles are defined • Joist layout in coordination with metal deck fasteners would be confirmed • Non-standard joist seat depths and/or sloping joist seat 	 <p>35 B1010.10-LOD-350 Floor Structural Frame (Steel Joists), From lkerd.com</p>
<p>400</p>	<p>Element modeling to include:</p> <ul style="list-style-type: none"> • Welds • Connection plates • Member fabrication part number • Quantity • Spacing • Anchorage • Material required for proper installation • Mark identification that correlates with bill of material <p>Type of shop paint if required</p>	 <p>36 B1010.10-LOD-400 Floor Structural Frame (Steel Joists), From lkerd.com</p>

B1010.10.70 21-02 10 10 10 70 Floor Structural Framing (Cold Formed Metal Framing)

Associated Masterformat Sections: 05 10 00 / 05 42 00 / 05 44 00



Unifomat Omniclass

100	See B10	
200	Element modeling to include: <ul style="list-style-type: none"> • Rough architectural masses • Approximate member depth • Desired member spacing 	
300	Element modeling to include: <ul style="list-style-type: none"> • floor element with design-specified locations and geometries 	
350	Element modeling to include: <ul style="list-style-type: none"> • Members modeled at any interface with wall edges (top, bottom, sides) or opening through wall • Bridging or straps 	
400	Element modeling to include: <ul style="list-style-type: none"> • Welds • Connections • Member fabrication part number • Any part required for complete installation 	

B1010.10 21-02 10 10 10 Floor Structural Frame (Masonry Framing)

Includes: Structural elements required for support of floor construction within basements and above grade. Includes columns, girders, beams, trusses, joists. Includes cast-in-place concrete, precast concrete, unit masonry, metal framed, and wood framed systems. Includes framed and sleeved openings for services. Includes Floor Construction Supplementary Components as appropriate.

Associated Masterformat Sections: 04 20 00

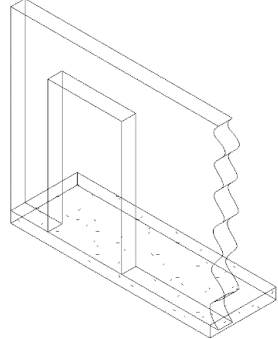
100	See B10	
200	See B10	 <p>37 B1010.10-LOD-200 Floor Structural Frame (Masonry Framing), From lkerd.com</p>

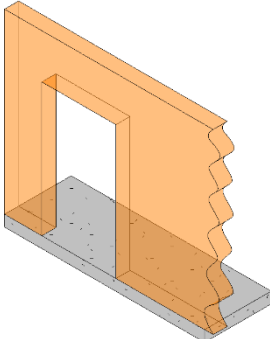
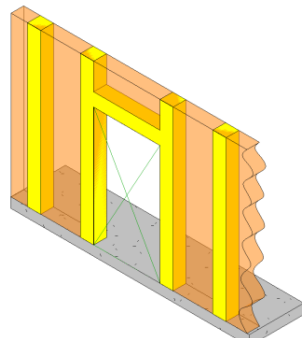

Unifomat Omniclass

300	<p>Element modeling to include:</p> <ul style="list-style-type: none">• floor element with design-specified locations and geometries	 <p>38 B1010.10-LOD-300 Floor Structural Frame (Masonry Framing), From lkerd.com</p>
350	<p>Element modeling to include:</p> <ul style="list-style-type: none">• Members modeled at any interface with wall edges (top, bottom, sides) or opening through wall• Any regions that would impact coordination with other systems such as but not limited to:<ul style="list-style-type: none">○ Bond Beam & Lintel Regions○ Reinforcing & Embed Regions○ Jam Regions○ Any other grouted regions	 <p>39 B1010.10-LOD-350 Floor Structural Frame (Masonry Framing), From lkerd.com</p>

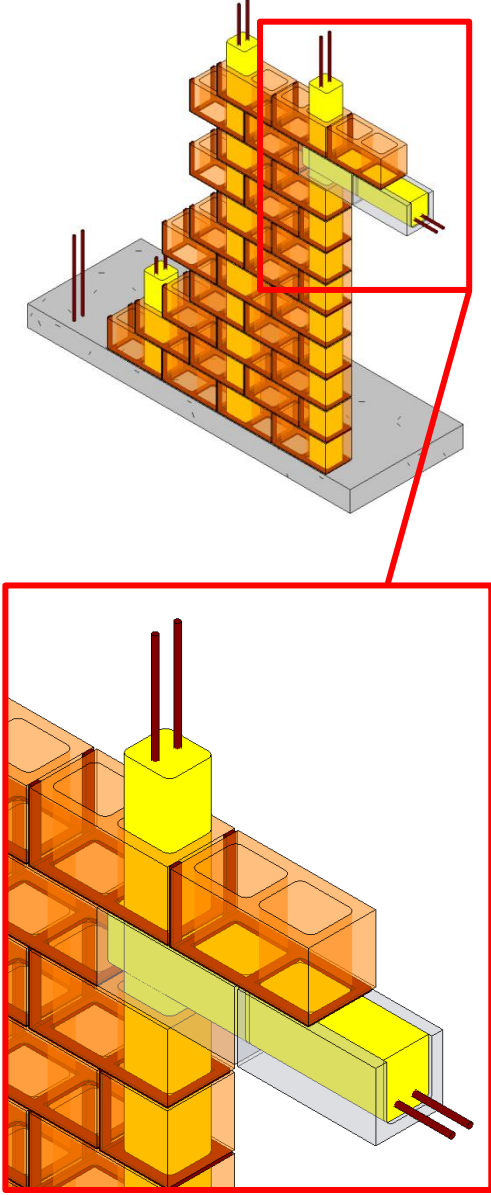

Unifomat Omniclass

400	<p>Element modeling to include:</p> <ul style="list-style-type: none">• Reinforcing• Connections• Grouting Material• Jams• Bond Beams• Lintels• Member fabrication part number• Any part required for complete installation	 <p>40 B1010.10-LOD-400 Floor Structural Frame (Masonry Framing), From lkerd.com</p>
-----	--	--



Unifomat Omniclass

Associated Masterformat Sections: 06 11 00 / 06 13 26 / 06 17 53

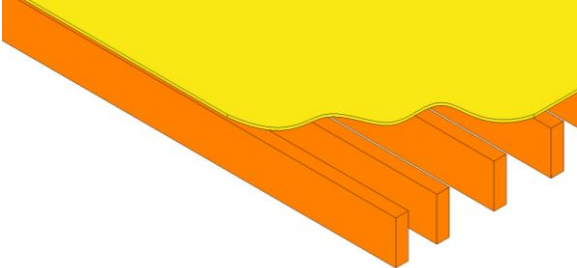
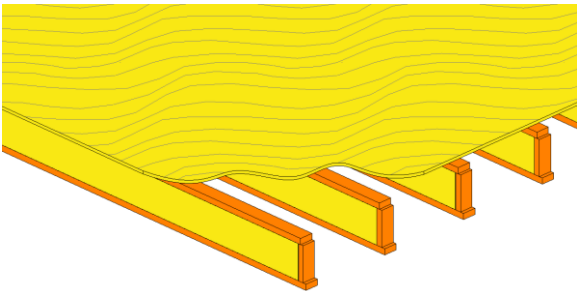
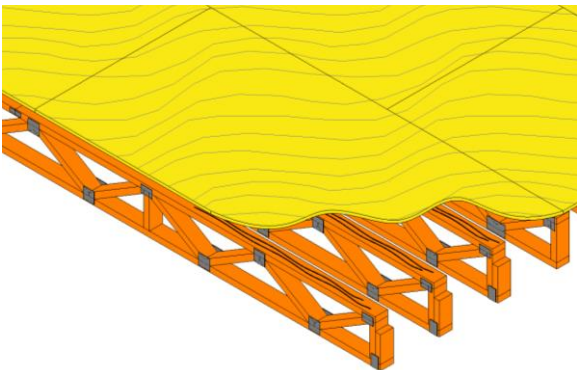
100	See B10	
200	<p>Element modeling to include:</p> <ul style="list-style-type: none"> • Top chord or bottom chord bearing • Truss orientation • Approximate depth • Approximate width • Truss orientation • Approximate centerline location of individual trusses 	 <p>41 B1010.10-LOD-200 Floor Structural Frame (Wood Floor Trusses), From lkerd.com</p>
300	<p>Element modeling to include:</p> <ul style="list-style-type: none"> • Truss size, depth, and material with sloping geometry • Spacing and end elevations • Support locations 	 <p>42 B1010.10-LOD-300 Floor Structural Frame (Wood Floor Trusses), From lkerd.com</p>
350	<p>Element modeling to include:</p> <ul style="list-style-type: none"> • Actual final truss profile with accurate panel points • Bridging and lateral braces • Fire protection coating • Any miscellaneous framing pertaining the truss • Erection details for installation • Chord and web member section profiles are accurately defined • Truss layout in coordination with deck fasteners would be confirmed • Hold down locations for large bolts. 	 <p>43 B1010.10-LOD-350 Floor Structural Frame (Wood Floor Trusses), From lkerd.com</p>

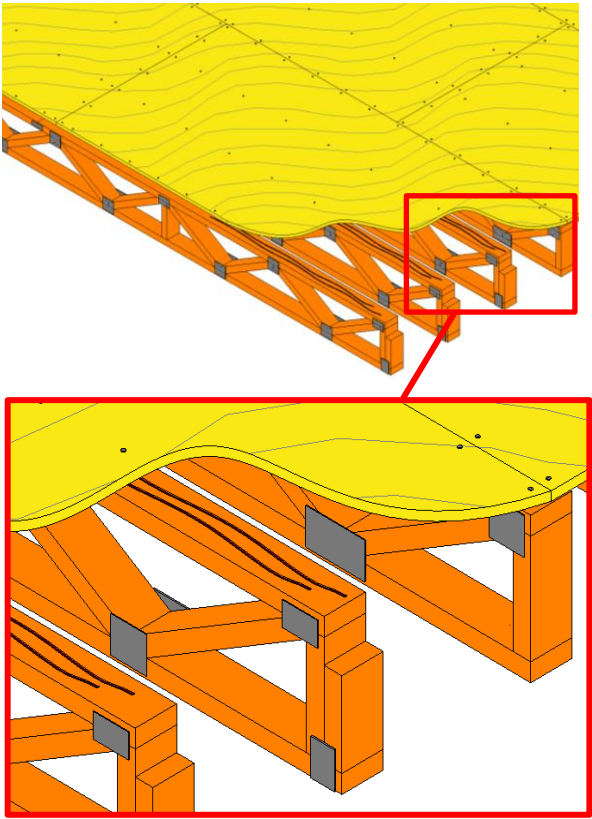

Unifomat Omniclass

400	<p>Element modeling to include:</p> <ul style="list-style-type: none">• Fasteners• Sealant• Truss plates and connection material• Nails and fasteners• Truss plates.• Deck patterns and joints	 <p>44 B1010.10-LOD-400 Floor Structural Frame (Wood Floor Trusses), From lkerd.com</p>
-----	---	---

B1010.20 21-02 10 10 20 Floor Decks, Slabs, and Toppings

Includes: Structural slab, deck, and sheathing floor construction at intermediate floors of basement construction and above grade. Includes cast-in-place concrete, precast concrete, cementitious decks and toppings, metal decking, wood sheathing, and wood decking. Includes framed and sleeved penetrations for services and housekeeping pads for equipment. Includes Floor Construction Supplementary Components as appropriate.

Specific structural systems within this section are listed as follows:

- [Wood Floor Deck](#)
- [Metal Floor Deck](#)
- [Composite Floor Deck](#)
- [Concrete](#)

Associated Masterformat Sections: 03 30 00 / 03 40 00 / 03 50 00 / 05 30 00 / 05 34 00
05 35 00 / 06 12 00 / 06 15 00 / 06 16 00 / 06 18 00 / 06 53 00 / 06 73 00



Uniformat Omniclass

B1010.20.10 21-02 10 10 20 10 Floor Decks, Slabs, and Toppings (Wood Floor Deck)

Associated Masterformat Sections: 06 12 00 / 06 15 00 / 06 16 00 / 06 18 00

100	See B10	
200	See B1010	
300	Element modeling to include: <ul style="list-style-type: none"> Applicable slopes Expected framing member profiles, spacing, and material 	
350	Element modeling to include: <ul style="list-style-type: none"> Deck edge location Actual framing member and location per manufacture All miscellaneous framing including braces, kickers, etc. Deck openings modeled with support framing around openings Point load locations Actual opening locations and sizes defined 	
400	Element modeling to include: <ul style="list-style-type: none"> All framing accessory and fasteners modeled per expected installation Waterproofing 	

B1010.20.20 21-02 10 10 20 20 Floor Decks, Slabs, and Toppings (Metal Floor Deck)

Associated Masterformat Sections: 05 30 00 / 05 34 00 / 05 35 00

100	See B10	
200	See B10	
300	Element modeling to include: <ul style="list-style-type: none"> Deck thickness Specific Framing member profiles, spacing, and material Opening locations are prescriptively defined with notes for additional miscellaneous framing Point load locations 	
350	Element modeling to include: <ul style="list-style-type: none"> Deck edge location Deck splice and end lap locations Actual deck profile and flute locations per manufacturer All miscellaneous framing including braces, kickers, etc. Deck openings modeled with support framing 	



Unifomat Omniclass

400	Element modeling to include: <ul style="list-style-type: none"> • All framing accessory and fasteners modeled per expected installation • Welds • Waterproofing 	
-----	--	--

B1010.20.30 21-02 10 10 20 30 Floor Decks, Slabs, and Toppings (Composite Floor Deck)

Associated Masterformat Sections: 06 73 00

100	See B10	
200	See B10	
300	Element modeling to include: <ul style="list-style-type: none"> • Specific deck thickness • Specific Framing member profiles, spacing, material • Opening locations are prescriptively defined with notes for additional miscellaneous framing 	
350	Element modeling to include: <ul style="list-style-type: none"> • Deck edge location • Actual deck profile and flute locations per manufacture • Deck splice and end lap locations • Actual framing member and location per manufacture • All miscellaneous framing including deck support, deck closure, shear studs, etc. • Slab openings modeled with support framing around openings • Point load locations • Slab reinforcing modeled if specified in BXP 	
400	Element modeling to include: <ul style="list-style-type: none"> • All framing accessory and fasteners modeled per expected installation • All slab reinforcing • Welds • Waterproofing 	

B1010.20.40 21-02 10 10 20 40 Floor Decks, Slabs, and Toppings (Concrete)

Associated Masterformat Sections: 03 30 00 / 03 40 00 / 03 50 00

100	See B10	
-----	-------------------------	--



Unifomat Omniclass

200	<p>Element modeling to include:</p> <ul style="list-style-type: none"> Type of structural concrete system (e.g. cast-in-place or precast) Approximate geometry (e.g. depth) of structural elements 	
300	<p>Element modeling to include:</p> <ul style="list-style-type: none"> Specific sizes and locations of main concrete structural members modeled per defined structural grid with correct orientation All sloping surfaces included in model element with exception of elements affected by manufacturer selection 	
350	<p>Element modeling to include:</p> <ul style="list-style-type: none"> Reinforcement called out, modeled if required by the BXP, typically only in congested areas Chamfer Pour joints and sequences to help identify reinforcing lap splice locations, scheduling, etc. Expansion Joints Embeds and anchor rods Post-tension profile and strands modeled if required by the BXP Penetrations for items such as MEP Any permanent forming or shoring components Shear reinforcing and stud rails 	
400	<p>Element modeling to include:</p> <ul style="list-style-type: none"> All reinforcement including post tension elements detailed and modeled Finishes 	

B1010.20.41 21-02 10 10 10 41 Precast Structural Double Tee (Concrete)

Includes: Structural elements required for support of floor construction within basements and above grade. Includes columns, girders, beams, trusses, joists. Includes cast-in-place concrete, precast concrete, unit masonry, metal framed, and wood framed systems. Includes framed and sleeved openings for services. Includes Floor Construction Supplementary Components as appropriate

Associated Masterformat Sections: 03 30 00 / 03 40 00 / 04 20 00 / 05 10 00 / 05 20 00
05 21 23 / 05 42 00 / 05 44 00 / 06 11 00 / 06 13 00 / 06 13 26 / 06 17 33 / 06 17 36
06 17 53 / 06 18 13 / 06 18 16 / 06 50 00

100	See B10B10	
-----	----------------------------	--

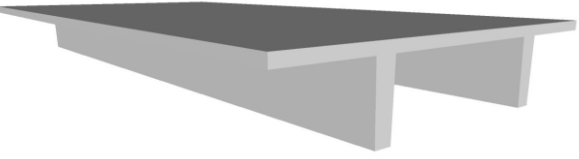
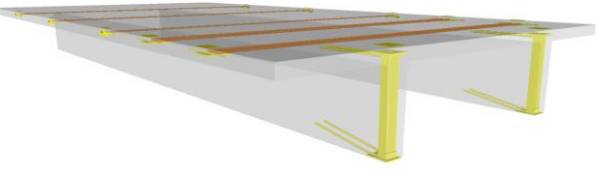
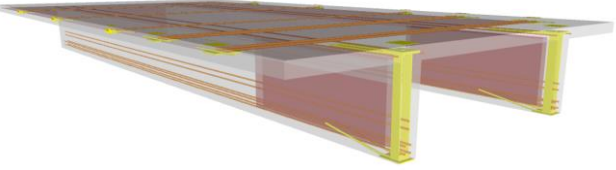

Unifomat Omniclass

200	<p>Element modeling to include:</p> <ul style="list-style-type: none"> • Approximate geometry (e.g. depth) of structural elements 	 <p><i>45 B1010.20 – LOD 200 Precast Structural Double Tee (Concrete), From lkerd.com</i></p>
300	<p>Element modeling to include:</p> <ul style="list-style-type: none"> • Specific sizes and locations of main concrete structural members modeled per defined structural grid with correct orientation • Concrete defined per spec (strength, air entrainment, aggregate size, etc.) • All sloping surfaces included in model element with exception of elements affected by manufacturer selection 	 <p><i>46 B1010.20 – LOD 300 Precast Structural Double Tee (Concrete), From lkerd.com</i></p>
350	<p>Element modeling to include:</p> <ul style="list-style-type: none"> • Reinforcing Post-tension profiles and strand locations • Reinforcement called out, modeled if required by the BXP, typically only in congested areas • Chamfer • Pour joints and sequences to help identify reinforcing lap splice locations, scheduling, etc. • Expansion Joints • Lifting devices • Embeds and anchor rods • Penetrations for items such as MEP • Any permanent forming or shoring components 	 <p><i>47 B1010.20 – LOD 350 Precast Structural Double Tee (Concrete), From lkerd.com</i></p>
400	<p>Element modeling to include:</p> <ul style="list-style-type: none"> • All reinforcement including post tension elements detailed and modeled • Finishes 	 <p><i>48 B1010.20 – LOD 400 Precast Structural Double Tee (Concrete), From lkerd.com</i></p>

B1010.30	21-02 10 10 30	Balcony Floor Construction	TBD
B1010.40	21-02 10 10 40	Mezzanine Floor Construction	TBD
B1010.50	21-02 10 10 50	Ramps	



Unifomat Omniclass

100	See fundamental definitions	
200	Generic model element Nominal overall unit scope shall include: • Nominal plan dimensions (length, width) • Nominal vertical dimensions (levels, landings)	
300	Major ramp support elements are modeled to disability access standards. Element is accurate as to • Width • Grade • Landing geometry	
350	Secondary ramp support elements are modeled (hangers, brackets, handrail, tactiles location, connection points etc.).	
400	All ramp elements are modeled to support fabrication and installation.	

B1010.90 21-02 10 10 50 Floor Construction Supplementary Components TBD

B1020 21-02 10 20 Roof Construction

Associated Masterformat Sections: 01 81 13

Note: This classification refers to roofs modeled as single composite objects (excluding structural frame). If individual layers are to be modeled refer to:

- [B1020.10](#) 21-02 10 20 10 Roof Structural Frame
- [B1020.20](#) 21-02 10 20 20 Roof Decks, Slabs, and Sheathing
- [B3010](#) 21-02 30 10 Roofing

B1020.10 21-02 10 20 10 Roof Structural Frame

Description: Structural elements required for support of floor construction within basements and above grade. Includes columns, girders, beams, trusses, joists. Includes cast-in-place concrete, precast concrete, unit masonry, metal framed, and wood framed systems. Includes framed and sleeved openings for services. Includes Floor Construction Supplementary Components as appropriate.

Associated Masterformat Sections: 03 30 00 / 03 40 00 / 04 20 00 / 05 10 00 / 05 20 00 / 05 21 23 / 05 42 00 / 05 44 00 / 06 11 00 / 06 13 00 / 06 13 26 / 06 17 33 / 06 17 36 / 06 17 53 / 06 18 13 / 06 18 16 / 06 50 00

[See [B1010.10](#)]



Unifomat Omniclass

B1020.20 21-02 10 20 20 Roof Decks, Slabs, and Sheathing

Includes: Structural roof deck, slab, and sheathing construction. Includes cast-in-place concrete, precast concrete, cementitious decks and toppings, metal decking, wood sheathing, wood decking, timber decking and expansion control. Includes framed and sleeved penetrations for services and housekeeping pads for equipment. Includes Roof Construction Supplementary Components as appropriate.

Associated Masterformat Sections: 03 30 00 / 03 40 00 / 03 50 00 / 03 52 00 / 05 30 00
05 34 00 / 05 35 00 / 06 12 00 / 06 15 00 / 06 16 00 / 06 18 00 / 06 53 00 / 06 73 00

100	N/A	
200	Generic roof objects separated by type of material Approximate thickness of layer represented by a single assembly. Layouts and locations still flexible.	
300	Penetrations are modeled to nominal dimensions for major roof openings such as skylights and large mechanical elements.	
350	All penetrations are modeled at actual rough-opening dimensions. Framing members at openings are modeled.	
400	Element modeling to include: <ul style="list-style-type: none"> • Studs and tracks • Individual masonry units • Reinforcing • Sheathing • Insulation 	

B1020.30 21-02 10 20 30 Canopy Construction

Includes: Structural frame and decks, slabs, and sheathing for canopy construction.

Associated Masterformat Sections: 03 30 00 / 03 40 00 / 05 10 00 / 05 19 19 / 05 20 00 / 06 11 00 / 06 12 00 / 06 13 00 / 06 15 00 / 06 16 00 / 06 17 00 / 06 18 00 / 06 50 00 / 06 73 00

[See [B1010.20](#)]

B1020.90 21-02 10 20 90 Roof Construction Supplementary Components TBD

Includes: Vapor retarders, air barriers, insulation, fireproofing, firestopping, and expansion control to be included with roof construction elements above as appropriate

B1080 21-02 10 80 Stairs

Includes: Stairs, fire escapes, metal walkways, and ladders.

Associated Masterformat Sections: 01 84 16

100	Assumptions for all stair systems (including railings, fire escapes, walkways, and ladders) are included in other modeled elements such as a spatial or massing element; or, schematic model	
-----	--	--



Unifomat Omniclass

	element that indicates the approximate overall dimensions of the stair layout.	
--	--	--

B1080.10 21-02 10 80 10 Stair Construction

Includes: Structural framing for exterior and interior stairs including treads, risers, and landings. Includes fire escapes and ladders.

Associated Masterformat Sections: 03 11 23 / 03 30 00 / 03 41 23 / 03 48 19 / 05 51 00
05 55 00 / 05 71 00 / 06 43 00

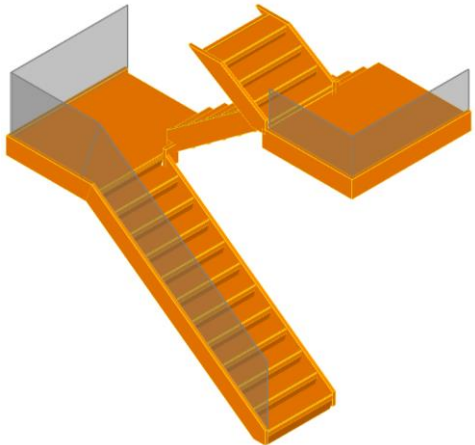
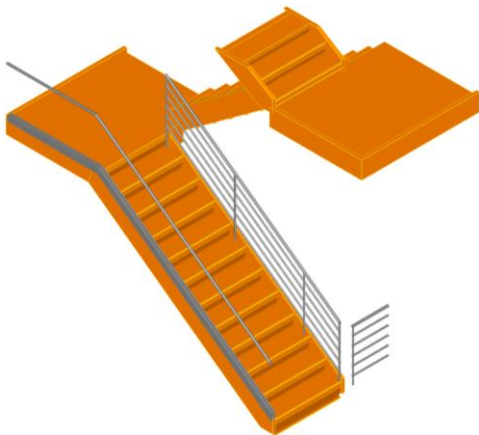
100	See B1080	
200	<p>Generic model element with simplified treads and risers.</p> <p>Nominal overall unit scope shall include:</p> <ul style="list-style-type: none"> Nominal plan dimensions (length, width) Nominal vertical dimensions (levels, landings) 	 <p>49 B1080.10-LOD-200 Stair Construction From lkerd.com</p>
300	<p>Major stair support elements are modeled (stringers).</p> <p>Element is accurate as to</p> <ul style="list-style-type: none"> Riser count Riser height Tread width Nosing conditions, including top and bottom Landing geometry 	 <p>50 B1080.10-LOD-300 Stair Construction From lkerd.com</p>

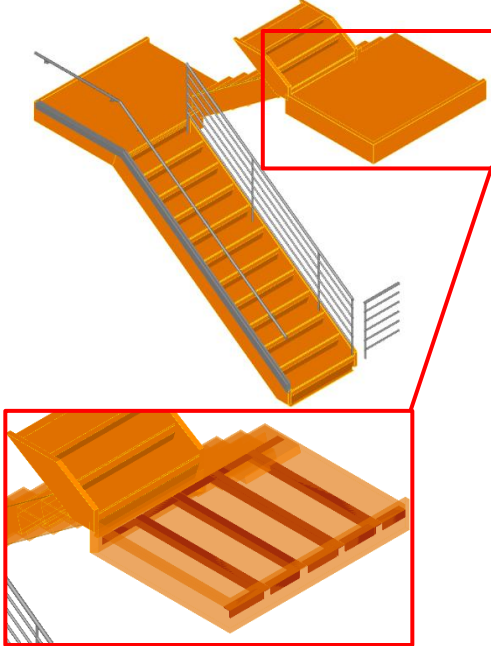

Uniformat Omniclass

350	Secondary stair support elements are modeled (hangers, brackets, handrail connection points etc.).	 <p>51 B1080.10-LOD-350 Stair Construction From lkerd.com</p>
-----	--	---

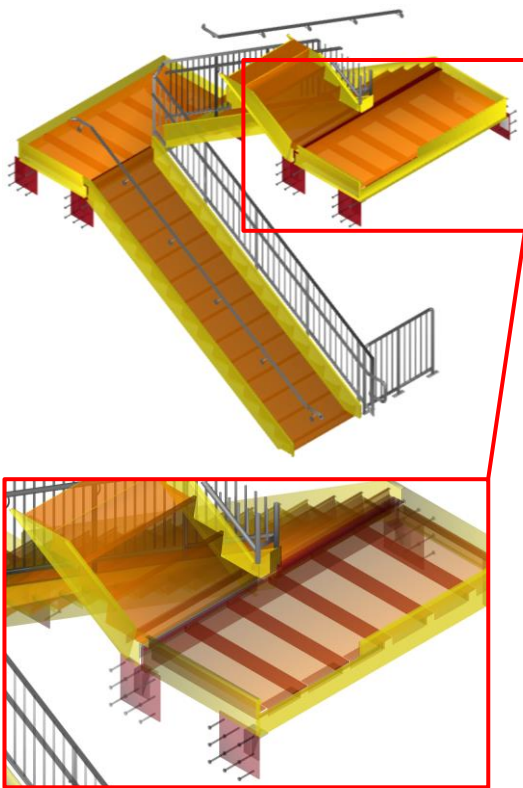

Unifomat Omniclass

<p>400</p>	<p>All stair elements are modeled to support fabrication and installation.</p>	 <p>52 B1080.10-LOD-400 Stair Construction From lkerd.com</p>
------------	--	---

B1080.20 21-02 10 80 10 Precast Structural Stairs (Concrete)

Includes: Structural framing for exterior and interior stairs including treads, risers, and landings. Includes fire escapes and ladders.

Associated Masterformat Sections: 03 11 23 / 03 30 00 / 03 41 23 / 03 48 19 / 05 51 00
05 55 00 / 05 71 00 / 06 43 00

<p>100</p>	<p>See B1080</p>	
------------	----------------------------------	--

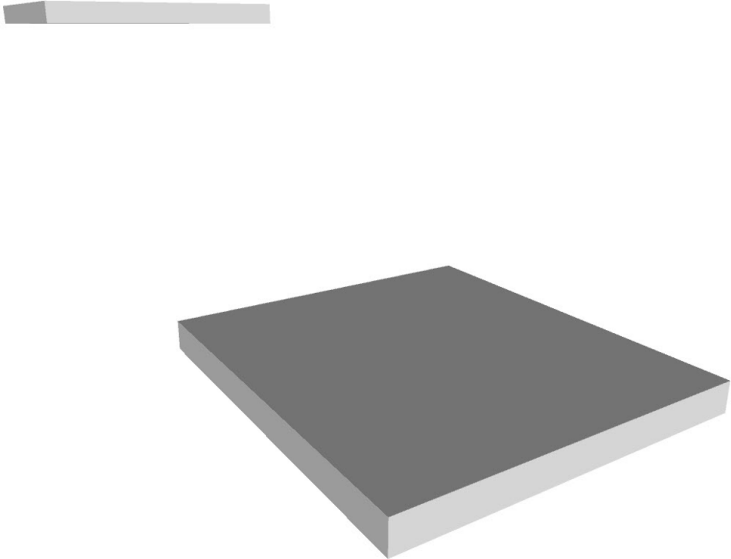
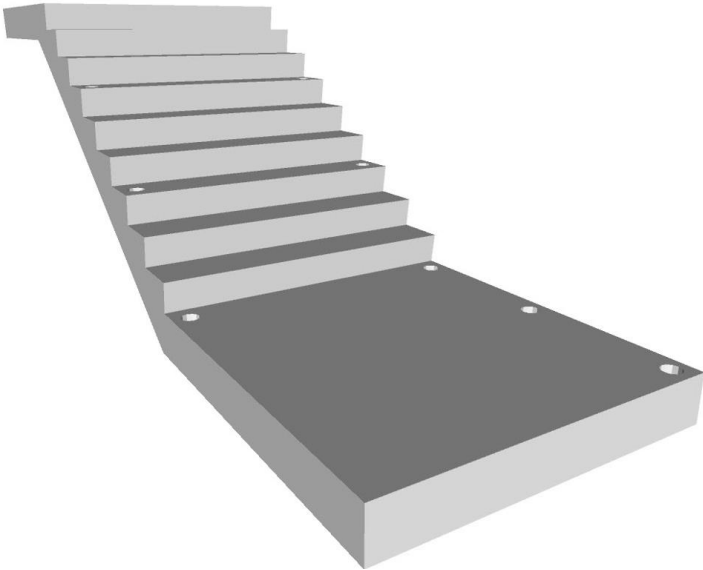

Unifomat Omniclass

200	<p>Element modeling to include:</p> <ul style="list-style-type: none">• Type of structural concrete system• Approximate geometry (e.g. depth) of structural elements	 <p>53 B1080.10-LOD 200 Precast Structural Stairs (Concrete), From lkerd.com</p>
300	<p>Element is accurate as to</p> <ul style="list-style-type: none">• Riser count• Riser height• Tread width• Nosing conditions, including top and bottom• Landing geometry	 <p>54 B1080.10-LOD 300 Precast Structural Stairs (Concrete), From lkerd.com</p>

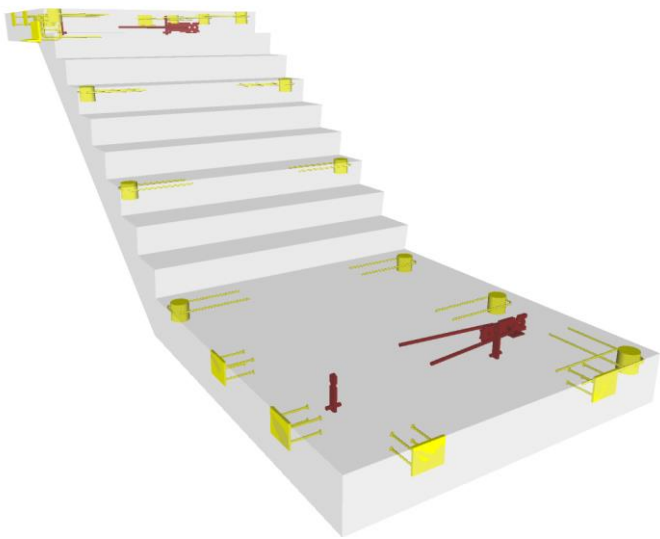
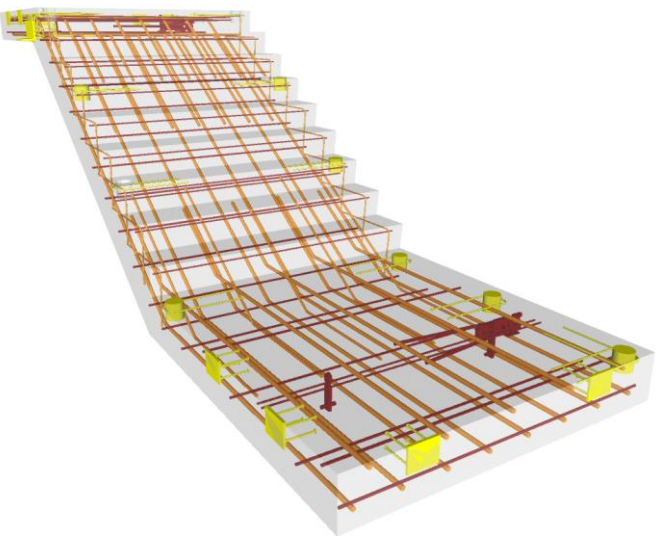

Unifomat Omniclass

<p>350</p>	<p>Element modeling to include:</p> <ul style="list-style-type: none"> • Reinforcing Post-tension profiles and strand locations • Reinforcement called out, modeled if required by the BXP, typically only in congested areas • Pour joints and sequences to help identify reinforcing lap splice locations, scheduling, etc. • Chamfer • Expansion Joints • Lifting devices • Embeds and anchor rods • Post-tension profile and strands modeled if required by the BXP • All penetrations modeled to rough opening dimensions. • Any permanent forming or shoring components 	 <p>55 B1080.10-LOD 350 Precast Structural Stairs (Concrete), From lkerd.com</p>
<p>400</p>	<p>Element modeling to include:</p> <ul style="list-style-type: none"> • All reinforcement including post tension elements detailed and modeled • Finishes, , etc. 	 <p>56 B1080.10-LOD 400 Precast Structural Stairs (Concrete), From lkerd.com</p>

B1080.30

21-02 10 80 30

Stair Soffits

TBD



Unifomat Omniclass

B1080.50 21-02 10 80 50 Stair Railings

Associated Masterformat Sections: 05 15 00 / 05 52 00 / 05 73 00 / 06 43 16 / 06 63 00
06 81 00

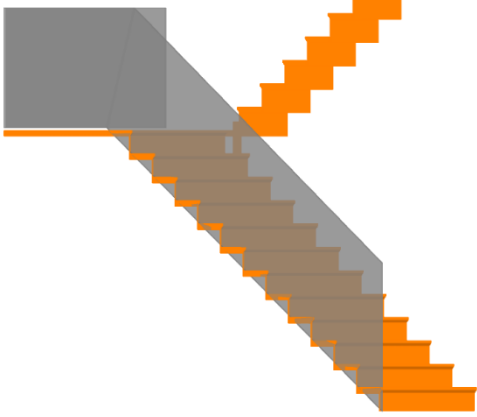
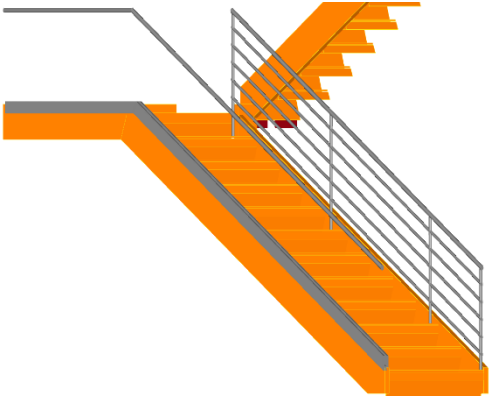
100	See B1080	
200	Generic model elements without articulation of material or railing structure such as balusters, posts, or supports.	 <p>57 B1080.50-LOD-200 Stair Railings, From Ikerd.com</p>
300	<p>Element is accurate as to</p> <ul style="list-style-type: none"> • Railing geometry • railing element spacing • Supports for wall mounted railings 	 <p>58 B1080.50-LOD-300 Stair Railings, From Ikerd.com</p>

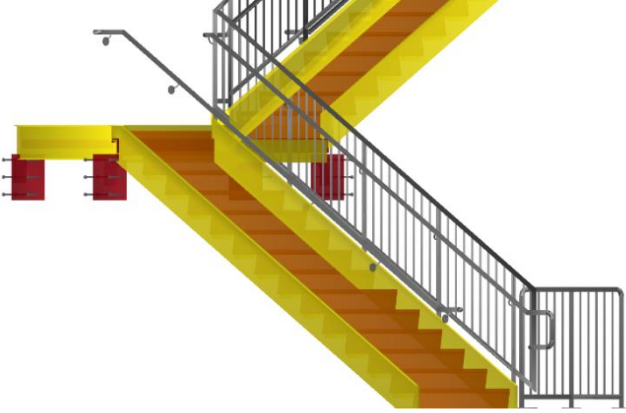

Unifomat Omniclass

400	[See Fundamental LOD Definitions]	 <p>59 B1080.50-LOD-400 Stair Railings, From lkerd.com</p>
-----	--	--

B1080.60 21-02 10 80 60 Fire Escapes

Associated Masterformat Sections: 05 51 23

[See [B1080.10](#) and [B1080.50](#)]

B1080.70 21-02 10 80 70 Metal Walkways

Includes: Catwalks and gratings over horizontal openings

Associated Masterformat Sections: 05 51 36 / 05 51 36.13 / 05 53 00

[See [B1080.10](#) and [B1080.50](#)]

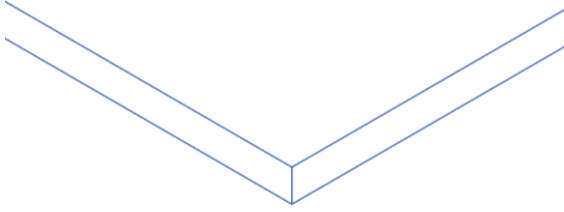
100	See B1080	
200	Grating type	 <p>B1080.70 LOD 200 Grating, From lkerd.com</p>

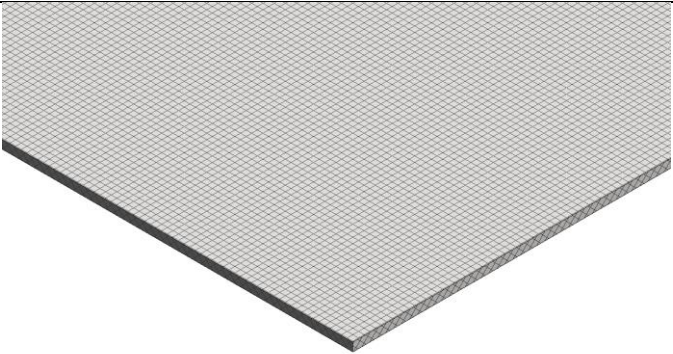
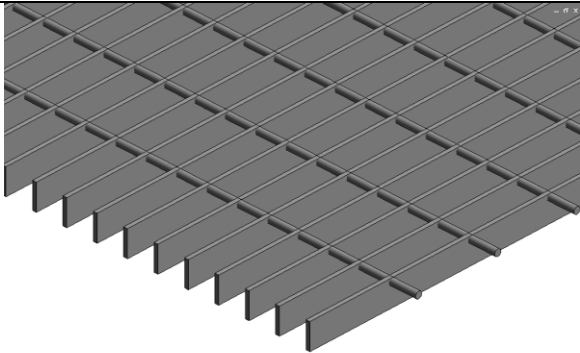

Unifomat Omniclass

300	<p>Element modeling to include:</p> <ul style="list-style-type: none"> • Grating type and overall geometry. • Thickness • Surface pattern showing span direction. 	 <p><i>B1080.70 LOD 300 Grating, From lkerd.com</i></p>
350	<p>Element modeling to include:</p> <ul style="list-style-type: none"> • Panel layout and grating deck edges. • Banding, openings, and grating penetrations. 	 <p><i>B1080.70 LOD 350 Grating, From lkerd.com</i></p>
400	<p>Element modeling to include:</p> <ul style="list-style-type: none"> • Full fabrication connections 	

B1080.80 21-02 10 80 80 Ladders
 Associated Masterformat Sections: 05 51 33 / 05 51 33.13 / 05 51 33.16 / 05 51 33.23
 [See [B1080.10](#) and [B1080.50](#)]

B20 21-02 20 Exterior Vertical Enclosures
 Associated Masterformat Sections: 01 83 16

100	<p>Solid mass model representing overall building volume; or, schematic wall elements that are not distinguishable by type or material.</p> <p>Assembly depth/thickness and locations still flexible.</p>	
-----	---	--



Unifomat Omniclass



B2010 21-02 20 10 Exterior Walls

Includes: Exterior Wall Supplementary Components as appropriate. Includes Exterior Wall Opening Supplementary Components as appropriate. Includes: Solid wall construction that is composite in nature; in other words, multiple layers of materials to form an overall assembly.

Associated Masterformat Sections: 01 83 16

Note: This classification refers to walls modeled as single composite objects. If individual layers are to be modeled refer to:

- [B2010.10](#) 21-02 20 10 10 Exterior Wall Veneer
- [B2010.20](#) 21-02 20 10 20 Exterior Wall Construction
- [B2010.30](#) 21-02 20 10 30 Exterior Wall Interior Skin

100	See B20	
200	<p>Generic wall objects separated by type of material (e.g. brick wall vs. terracotta).</p> <p>Approximate overall wall thickness represented by a single assembly.</p> <p>Layouts and locations still flexible.</p>	 <p>60 B2010-LOD-200 Exterior Walls, From lkerd.com</p>
300	<p>Single model element with specific overall thickness that accounts for veneer, structure, insulation, air space, and interior skin specified for the wall system. (Refer to LOD350 and LOD400 for individually modeled elements)</p> <p>Penetrations are modeled to nominal dimensions for major wall openings such as windows, doors, and large mechanical elements.</p>	 <p>61 B2010-LOD-300 Exterior Walls, From lkerd.com</p>



Unifomat Omniclass

<p>350</p>	<p>May be modeled as a single model element.</p> <p>Main structural members such as headers and jambs at openings are modeled.</p> <p>All penetrations are modeled at actual rough-opening dimensions.</p>	 <p>62 B2010-LOD-350 Exterior Walls, From lkerd.com</p>
------------	--	---

B2010.10 21-02 20 10 10 Exterior Wall Veneer

Includes: Nonstructural outside face elements of exterior walls. Includes precast concrete, unit masonry, EIFS, manufactured siding, and stucco Includes water repellents, coatings, and painting.

Associated Masterformat Sections: 03 40 00 / 04 20 00 / 04 26 13 / 04 42 00 / 04 43 13
04 70 00 / 05 19 13 / 06 20 13 / 06 61 00 / 07 19 00 / 07 24 00 / 07 42 00 / 07 44 00
07 46 00 / 09 24 00 / 09 24 23 / 09 90 00

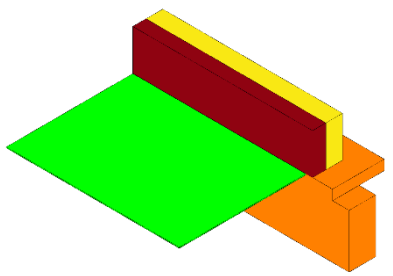
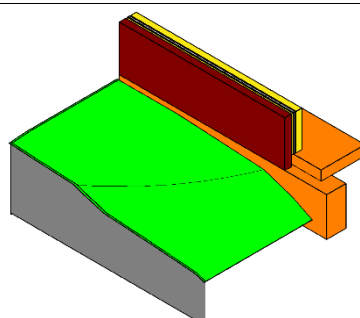
<p>100</p>	<p>N/A</p>	
<p>200</p>	<p>Generic wall objects separated by type of material (e.g. brick wall vs. terracotta).</p> <p>Approximate thickness of layer represented by a single assembly.</p> <p>Layouts and locations still flexible.</p>	 <p>63 B2010.10-LOD-200 Exterior Wall Veneer, From lkerd.com</p>
<p>300</p>	<p>Exterior wall veneer modeled as a separate element.</p> <p>Specific wall modeled to actual dimensions.</p> <p>Penetrations are modeled to nominal dimensions for major wall openings such as windows, doors, and large mechanical elements.</p>	 <p>64 B2010.10-LOD-300 Exterior Wall Veneer From lkerd.com</p>

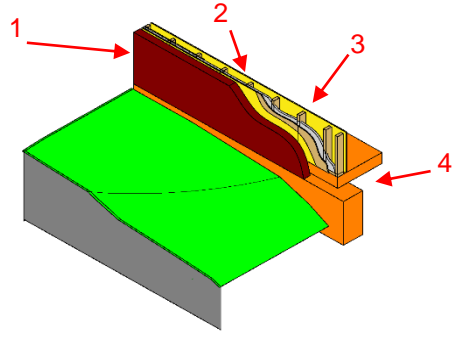
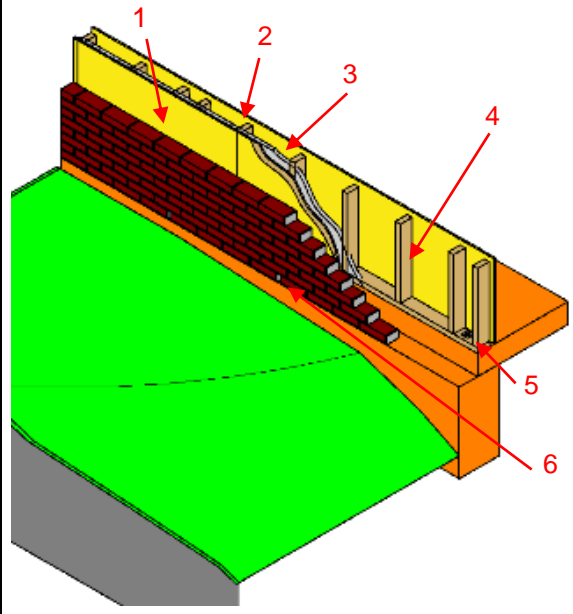

Unifomat Omniclass

<p>350</p> <p>Exterior wall veneer modeled as a separate element.</p> <p>All penetrations are modeled at actual rough-opening dimensions.</p> <p>Precast concrete panels are individually modeled. Connection points are specified.</p> <p>Connection to interfacing systems</p> <p><i>Images notes:</i></p> <ul style="list-style-type: none"> • Wall veneer element • Skin layers including but not limited to waterproofing membrane • Core framing • Concrete slab edge 		 <p>65 B2010.10-LOD-350 Exterior Wall Veneer From lkerd.com</p>
<p>400</p> <p>Element modeling includes:</p> <p><i>Image notes:</i></p> <ul style="list-style-type: none"> • Individual masonry units • Skin layers including • Moisture barrier, sheathing, and insulation • Core framing • Bolt • Concrete slab edge • Weep holes 		 <p>66 B2010.10-LOD-400 Exterior Wall Veneer From lkerd.com</p>

B2010.20 21-02 20 10 20 Exterior Wall Construction

Includes: Exterior wall construction including backup systems for wall veneer. May be vertical load bearing. Includes cast-in-place concrete walls, precast concrete walls, unit masonry walls, metal framed wall systems, and wood framed wall systems.

Associated Masterformat Sections: 03 30 00 / 03 40 00 / 04 20 00 / 05 41 00 / 06 11 00
06 12 00 / 06 16 00



Unifomat Omniclass

100	N/A	
200	<p>Generic wall objects separated by type of material (e.g. brick wall vs. terracotta).</p> <p>Approximate thickness of layer represented by a single assembly.</p> <p>Layouts and locations still flexible.</p>	
300	<p>Specific wall modeled to actual dimensions.</p> <p>Penetrations are modeled to nominal dimensions for major wall openings such as windows, doors, and large mechanical elements.</p>	
350	<p>Exterior wall construction modeled as a separate element.</p> <p>All penetrations are modeled at actual rough-opening dimensions.</p> <p>Headers and jamb framing are modeled.</p>	
400	<p>Element modeling to include:</p> <ul style="list-style-type: none"> • Studs and tracks • Individual masonry units • Reinforcing • Sheathing • Insulation 	

B2010.20.10 21-02 20 10 20 10 Exterior Wall Construction (Wood)

Includes: Exterior Wall Supplementary Components as appropriate. Includes Exterior Wall Opening Supplementary Components as appropriate. Includes: Solid wall construction that is composite in nature; in other words, multiple layers of materials to form an overall assembly.

Associated Masterformat Sections: 01 83 16

100	N/A	
-----	-----	--

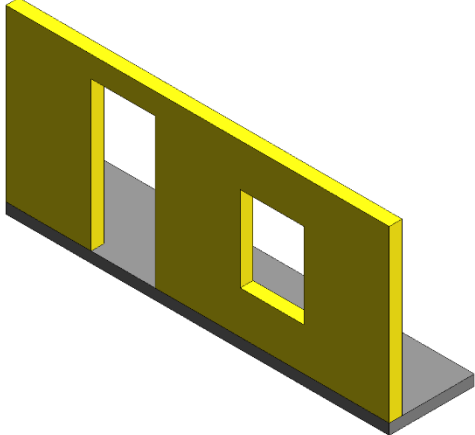
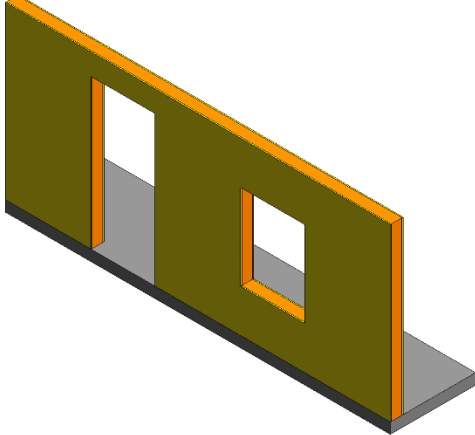

Unifomat Omniclass

200	<p>Generic wall objects separated by type of material (e.g. brick wall vs. terracotta).</p> <p>Approximate thickness of layer represented by a single assembly.</p> <p>Layouts and locations still flexible.</p>	 <p>67 B2010.06-LOD-200 Exterior Wall (Wood) From lkerd.com</p>
300	<p>Specific wall modeled to actual dimensions.</p> <p>Penetrations are modeled to nominal dimensions for major wall openings such as windows, doors, and large mechanical elements.</p> <p>Shear panels</p>	 <p>68 B2010.06-LOD-300 Exterior Wall (Wood) From lkerd.com</p>

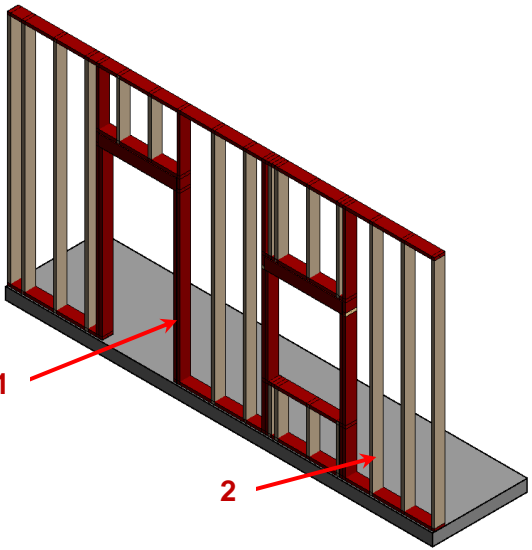
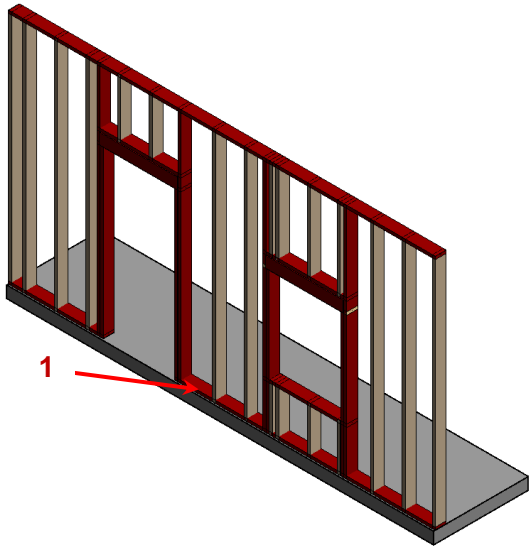

Unifomat Omniclass

<p>350</p>	<p>Wood framing is developed with sufficient elements to support detailed interface coordination with other systems such as MEP.</p> <p>All penetrations are modeled at actual rough-opening dimensions.</p> <p>Openings modeled with support framing around openings</p> <p><i>Image notes:</i></p> <ol style="list-style-type: none"> 1) Elements in red are critical wall support elements that cannot be easily cut for coordination of MEP opening through the walls. 2) Infill wood framing modeling may be omitted at this LOD if stated in the BXP. 3) Cladding and sheathing are not shown for clarity in this image. 	 <p>69 B2010.06-LOD-350 Exterior Wall (Wood) From lkerd.com</p>
<p>400</p>	<p>Wood framing is developed with sufficient elements that support the fabrication of the wood framing system.</p> <p><i>Image notes:</i></p> <ol style="list-style-type: none"> 1) Connection content is development in the wall elements. This includes but is not limited to fasteners, anchor rods, and other related hardware. 2) Cladding and sheathing are not shown for clarity in this image. 	 <p>70 B2010.06-LOD-400 Exterior Wall (Wood) From lkerd.com</p>



Unifomat Omniclass

B2010.20.20 21-02 20 10 20 20 Exterior Wall Construction (Cold-Form Metal Framing)

Includes: Exterior Wall Supplementary Components as appropriate. Includes Exterior Wall Opening Supplementary Components as appropriate. Includes: Solid wall construction that is composite in nature; in other words, multiple layers of materials to form an overall assembly.

Associated Masterformat Sections: 01 83 16

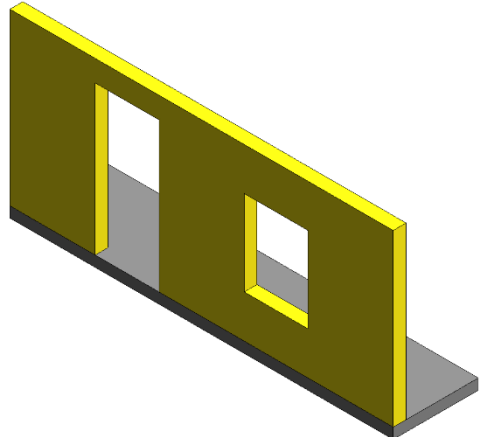
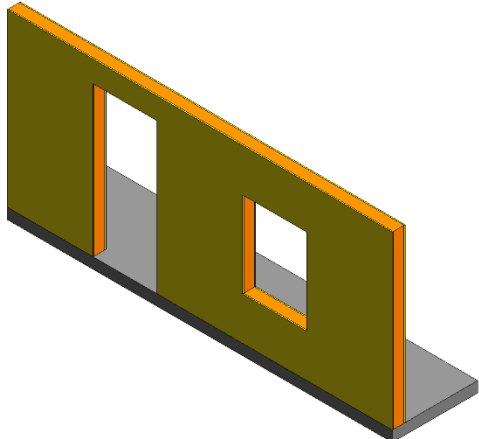
100	N/A	
200	<p>Generic wall objects separated by type of material (e.g. brick wall vs. terracotta).</p> <p>Approximate thickness of layer represented by a single assembly.</p> <p>Layouts and locations still flexible.</p>	 <p>71 B2010.05-LOD-200 Exterior Wall (Cold-Form Metal Framing), From lkerd.com</p>
300	<p>Specific wall modeled to actual dimensions.</p> <p>Penetrations are modeled to nominal dimensions for major wall openings such as windows, doors, and large mechanical elements.</p> <p>Shear panels</p>	 <p>72 B2010.05-LOD-300 Exterior Wall (Cold-Form Metal Framing), From lkerd.com</p>

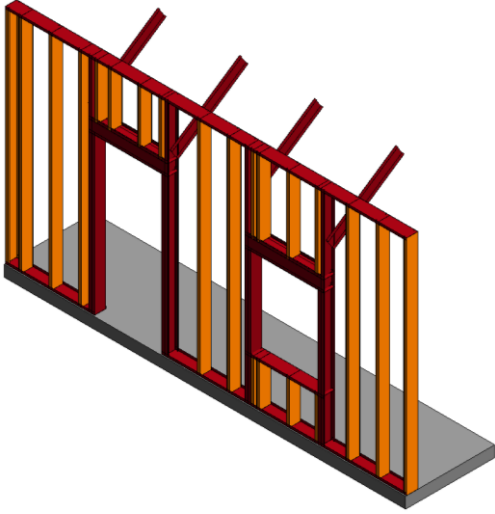

Unifomat Omniclass

<p>350</p>	<p>Cold formed metal framing is developed with sufficient elements to support detailed interface coordination with other systems such as MEP.</p> <p>All penetrations are modeled at actual rough-opening dimensions.</p> <p>Openings modeled with support framing around openings</p> <p><i>Image notes:</i></p> <ul style="list-style-type: none">• <i>Elements in red are critical wall support elements that cannot be easily cut for coordination of MEP opening through the walls.</i>• <i>Diagonal bracing (kickers) that may be in the above ceiling space are modeled for coordination with other building content such as MEP passing along the wall in the above ceiling spaces.</i>• <i>Infill cold formed metal framing modeling (Orange) may be omitted at this LOD if stated in the BXP.</i>• <i>Cladding and sheathing are not shown for clarity in this image.</i>	 <p>73 B2010.05-LOD-350 Exterior Wall (Cold-Form Metal Framing), From lkerd.com</p>
------------	--	--

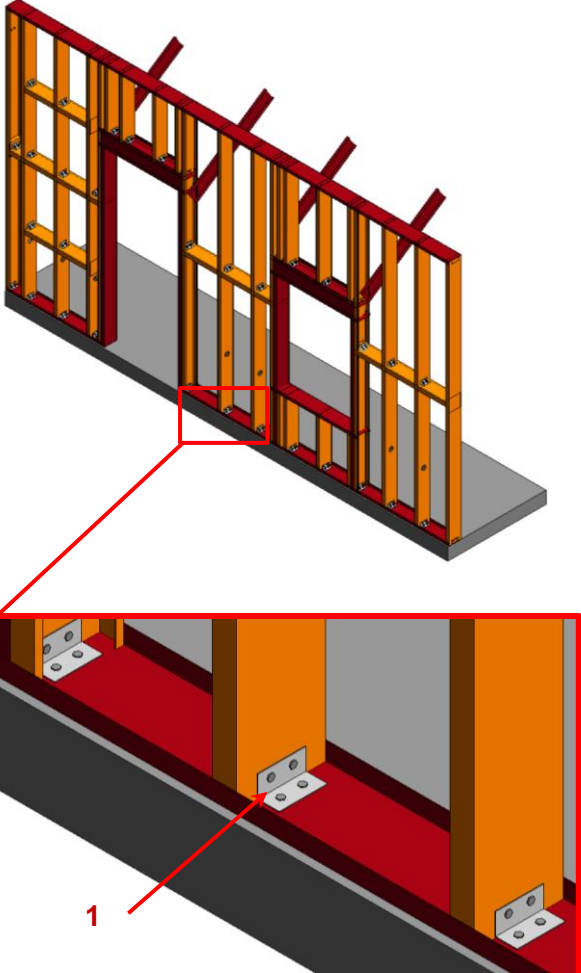

Unifomat Omniclass

<p>400</p>	<p>Cold formed metal framing is developed with sufficient elements that support the fabrication of the CFMF system.</p> <p><i>Image notes:</i></p> <ul style="list-style-type: none"> • Connection content is development in the wall elements. This includes but is not limited to fasteners, clips, and other related hardware. • Cladding and sheathing are not shown for clarity in this image. 	 <p>74 B2010.05-LOD-400 Exterior Wall (Cold-Form Metal Framing), From lkerd.com</p>
------------	---	---

B2010.20.30 21-02 20 10 20 30 Exterior Wall Construction (Masonry)

Includes: Exterior Wall Supplementary Components as appropriate. Includes Exterior Wall Opening Supplementary Components as appropriate. Includes: Solid wall construction that is composite in nature; in other words, multiple layers of materials to form an overall assembly.

Associated Masterformat Sections: 01 83 16

100	N/A	
-----	-----	--

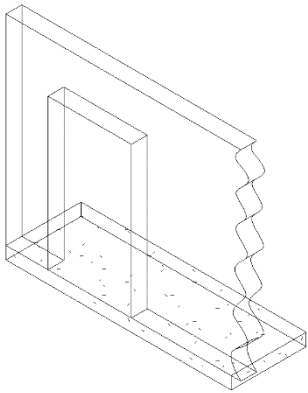
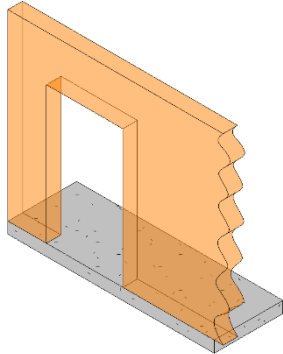
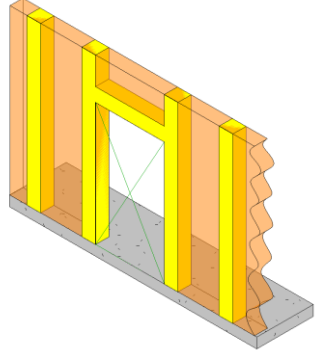

Unifomat Omniclass

<p>200</p>	<p>Generic wall objects separated by type of material (e.g. brick wall vs. terracotta).</p> <p>Approximate thickness of layer represented by a single assembly.</p> <p>Layouts and locations still flexible.</p>	 <p>75 B2010.04-LOD-200 Exterior Wall (Masonry), From lkerd.com</p>
<p>300</p>	<p>Specific wall modeled to actual dimensions.</p> <p>Penetrations are modeled to nominal dimensions for major wall openings such as windows, doors, and large mechanical elements.</p> <p>Shear panels</p>	 <p>76 B2010.04-LOD-300 Exterior Wall (Masonry), From lkerd.com</p>
<p>350</p>	<p>Element modeling to include:</p> <ul style="list-style-type: none"> • Members modeled at any interface with wall edges (top, bottom, sides) or opening through wall • All penetrations are modeled at actual rough-opening dimensions. • Openings modeled with support framing around openings • Any regions that would impact coordination with other systems such as but not limited to: <ul style="list-style-type: none"> ○ Bond Beam & Lintel Regions ○ Reinforcing & Embed Regions ○ Jam Regions ○ Any other grouted regions 	 <p>77 B2010.04-LOD-350 Exterior Wall (Masonry) From lkerd.com</p>

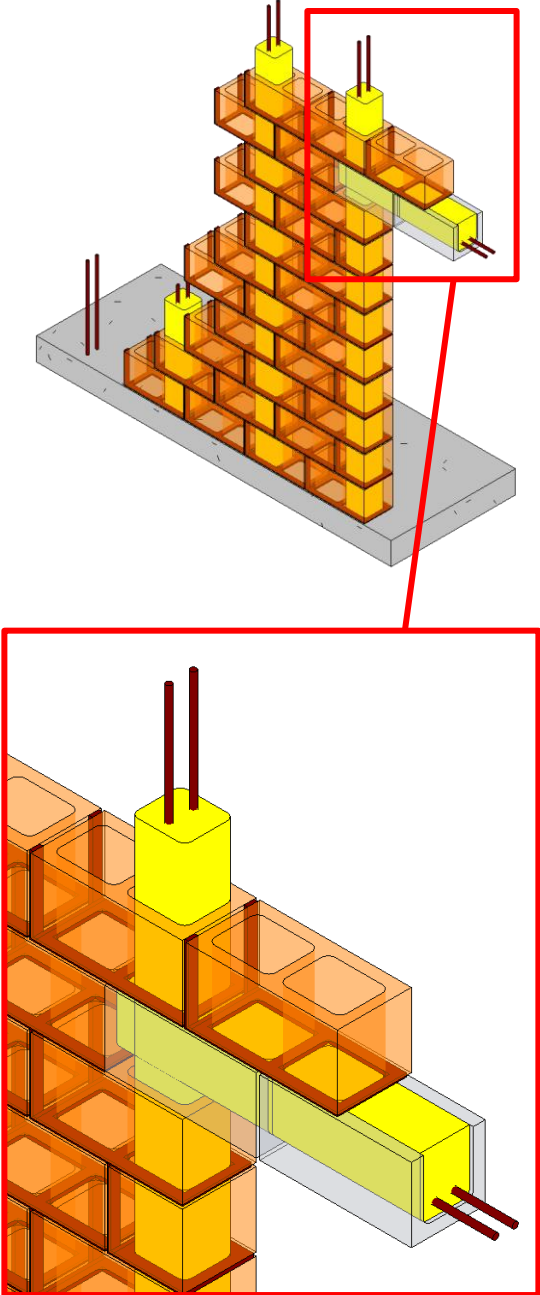

Unifomat Omniclass

400	<p>Element modeling to include:</p> <ul style="list-style-type: none">• Reinforcing• Connections• Grouting Material• Jams• Bond Beams• Lintels• Member fabrication part number• Any part required for complete installation	 <p>78 B2010.04-LOD-400 Exterior Wall (Masonry), From lkerd.com</p>
-----	--	---



Unifomat Omniclass

B2010.20.40 21-02 20 10 20 40 Precast Wall Construction (Concrete)

Includes: Exterior wall construction including backup systems for wall veneer. May be vertical load bearing. Includes cast-in-place concrete walls, precast concrete walls, unit masonry walls, metal framed wall systems, and wood framed wall systems.

Associated Masterformat Sections: 03 30 00 / 03 40 00 / 04 20 00 / 05 41 00 / 06 11 00
06 12 00 / 06 16 00

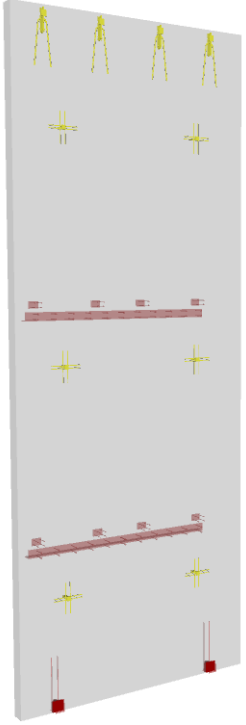
100	N/A	
200	<p>Generic wall objects separated by type of material (e.g. brick wall vs. terracotta).</p> <p>Approximate thickness of layer represented by a single assembly.</p> <p>Layouts and locations still flexible.</p>	
300	<p>Specific wall modeled to actual dimensions.</p> <p>Penetrations are modeled to nominal dimensions for major wall openings such as windows, doors, and large mechanical elements.</p> <p>Shear panels</p>	
350	<p>Element modeling to include:</p> <ul style="list-style-type: none"> • Reinforcing Post-tension profiles and strand locations • Reinforcement called out, modeled if required by the BXP, typically only in congested areas • Pour joints and sequences to help identify reinforcing lap splice locations, scheduling, etc. • Expansion Joints • Lifting devices • Embeds and anchor rods • Post-tension profile and strands modeled if required by the BXP • All penetrations are modeled at actual rough-opening dimensions. • Any permanent forming or shoring components • Chamfer, reveals, etc. 	 <p>79 B2010.20- LOD 350 Precast Wall (Concrete), From lkerd.com</p>

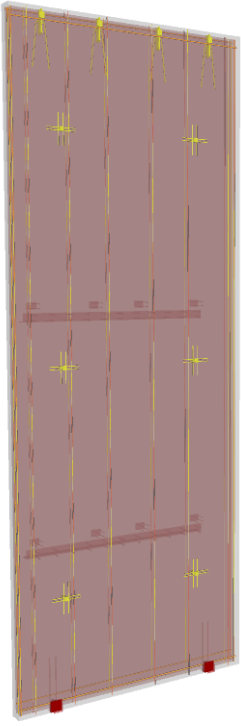

Unifomat Omniclass

<p>400</p>	<p>Element modeling to include:</p> <ul style="list-style-type: none"> All reinforcement including post tension elements detailed and modeled 	 <p>80 B2010.20- LOD 400 Precast Wall (Concrete), From lkerd.com</p>
------------	--	---

B2010.30 21-02 20 10 30 Exterior Wall Interior Skin

Includes: Materials to provide finish or protective covering on inside of face of exterior walls. May include insulation and vapor retarder.

Associated Masterformat Sections: 09 20 00

<p>100</p>	<p>N/A</p>	
<p>200</p>	<p>Generic wall objects separated by type of material (e.g. brick wall vs. terracotta).</p> <p>Approximate thickness of layer represented by a single assembly.</p> <p>Layouts and locations still flexible.</p>	
<p>300</p>	<p>Specific wall modeled to actual dimensions.</p> <p>Penetrations are modeled to nominal dimensions for major wall openings such as windows, doors, and large mechanical elements.</p>	



Unifomat Omniclass

350	Exterior wall interior skin modeled as a separate element. All openings modeled to rough opening dimensions.	
400	Element modeling to include: <ul style="list-style-type: none"> 1) Studs and tracks <ul style="list-style-type: none"> • Individual masonry units • Reinforcing • Wall board • Insulation 	

B2010.40 21-02 20 10 40 Fabricated Exterior Wall Assemblies TBD

Includes: Manufactured or fabricated assemblies that include exterior veneer and wall construction within one fabricated assembly and may also include interior skin. Includes Exterior Wall Supplementary Components as appropriate.

Associated Masterformat Sections: 04 25 00 / 07 42 63 / 07 44 63 / 08 44 00 / 08 45 00

Note: For Curtain Walls see:

B2020.30 21-02 20 20 30 Exterior Window Wall

B2010.50 21-02 20 10 50 Parapets

Includes: Exterior wall construction above plane of roof.

Associated Masterformat Sections: 03 30 00 / 03 40 00 / 04 20 00 / 05 41 00 / 06 11 00
06 12 00 / 06 16 00

[See [B2010](#), [B2010.10](#), [B2010.20](#), and [B2010.30](#)]

B2010.60 21-02 20 10 60 Equipment Screens

Includes: Exterior wall construction to screen equipment from public view.

Associated Masterformat Sections: 03 40 00 / 04 20 00 / 08 92 00

[See [B2010](#), [B2010.10](#), [B2010.20](#), and [B2010.30](#)]

B2010.80 21-02 20 10 80 Exterior Wall Supplementary Components TBD

B2010.90 21-02 20 10 90 Exterior Wall Opening Supplementary Components TBD

B2020 21-02 20 20 Exterior Windows

Includes: Fixed or operable windows used singly and in multiples located in the exterior vertical enclosure. Includes Exterior Window Supplementary Components as appropriate. Includes windows units with louver blinds integrally set between glass panels. Includes metal, wood, plastic, and composite window units. May Include: Wall Opening Supplementary Components as appropriate.

Associated Masterformat Sections: 01 83 16 / 08 50 00

100	See B20	
-----	-------------------------	--



Unifomat Omniclass

200	Windows approximate in terms of location, size, count and type. Units are modeled as a simple, monolithic component; or represented with simple frame and glazing. Nominal unit size is provided.	
-----	--	--

B2020.10 21-02 20 20 10 Exterior Operating Windows

Includes: Window screens and storm windows.

Associated Masterformat Sections: 08 50 00 / 08 51 66 / 08 52 66 / 08 53 66 / 08 54 66
08 51 69 / 08 52 69 / 08 53 69 / 08 54 69

100	See B20	
200	See B2020	
300	Units are modeled based on specified location and nominal size. Outer geometry (profile) of window frame elements and glazing modeled in correct location Operation is indicated.	
350	Attachment method of window to structure Embed elements Backer rod and sealant	
400	Detailed frame extrusion profiles Glazing sub-components (gaskets) Attachment components 1) End dam 2) Fasteners	

B2020.20 21-02 20 20 20 Exterior Fixed Windows

Associated Masterformat Sections: 08 50 00

[See [B2020.10](#)]

B2020.30 21-02 20 20 30 Exterior Window Wall

Associated Masterformat Sections: 08 43 00

100	See B20	
-----	-------------------------	--

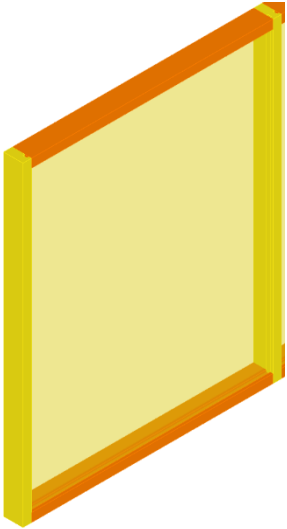

Unifomat Omniclass

<p>200</p>	<p>Generic wall objects representing major types of proposed window wall assemblies.</p> <p>Overall window wall assembly depth represented by a single model object.</p> <p>Layouts and locations still flexible.</p>	 <p><i>81 B2020.30-LOD-200 Exterior Window Wall, From lkerd.com</i></p>
<p>300</p>	<p>Specified location and orientation of face of glass.</p> <p>Nominal face dimensions and thickness of glazing.</p> <p>Spacing, location, size and orientation of mullions.</p> <p>Operable components defined (windows, louvers and doors) and included in model.</p>	 <p><i>82 B2020.30-LOD-300 Exterior Window Wall, From lkerd.com</i></p>

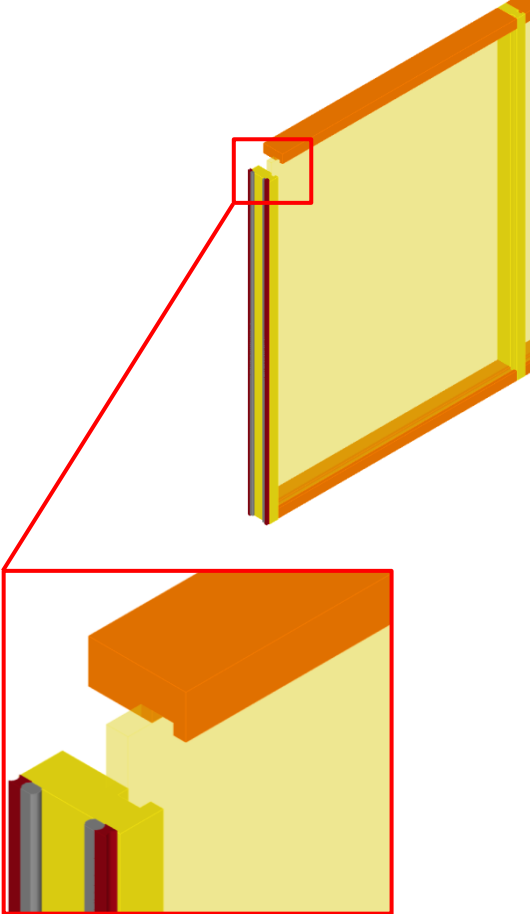

Unifomat Omniclass

<p>350</p>	<p>Mullion shapes and geometry defined. Actual anchorage layouts and types defined and modeled. Actual panel dimensions (including seating).</p>	 <p>83 B2020.30-LOD-350 Exterior Window Wall, From lkerd.com</p>
------------	--	--

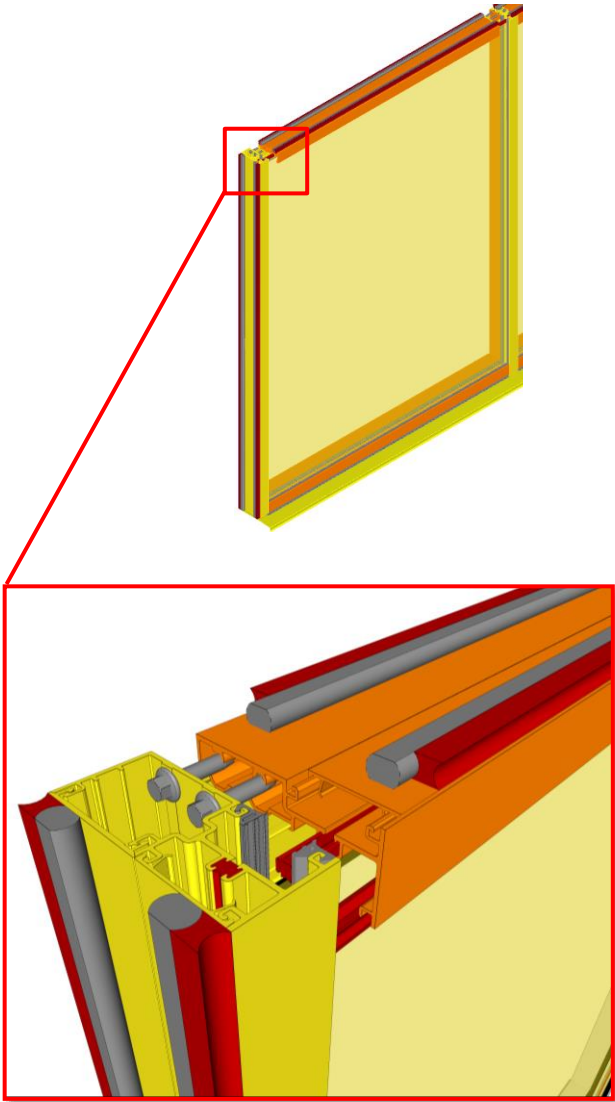

Unifomat Omniclass

<p>400</p>	<p>Complete mullion extrusion profiles. Interface details between wall systems (within) and wall and support systems including sealants, end dams, flashings and membranes.</p>	 <p>84 B2020.30-LOD-400 Exterior Window Wall, From lkerd.com</p>
------------	---	--

B2020.50 21-02 20 20 50 Exterior Special Function Windows

Includes: Exterior windows with special characteristics for a special function.

Associated Masterformat Sections: 08 56 00 / 08 55 00 / 08 88 39 / 08 56 19 / 08 56 46
08 56 49 / 08 88 49 / 08 56 53 / 08 88 53 / 08 88 56 / 08 56 63 / 08 56 73 / 08 75 00
08 80 00

[See [B2020.10](#)]



Unifomat Omniclass

B2050 21-02 20 50 Exterior Doors and Grilles

Includes: Doors, grilles, and gates located in the exterior vertical enclosure. Includes screen and storm door assemblies. Includes Exterior Door Supplementary Components as appropriate. May Include: Wall Opening Supplementary Components as appropriate.

Associated Masterformat Sections: 01 83 16

100	Simple representation of a door unit. Size, count, and location are approximate.	
200	Units are modeled as a simple, monolithic component; or represented with simple frame and panel. Nominal unit size is provided.	

B2050.10 21-02 20 50 10 Exterior Entrance Doors

Includes: Exterior personnel door assemblies at main entrances. Includes automatic, revolving, balanced, and other special operating entrance doors, and sliding storefront wall systems.

Associated Masterformat Sections: 08 32 00 / 08 42 00 / 08 42 26 / 08 42 29 / 08 42 33
08 42 36 / 08 43 29

100	See B20	
200	See B2050	
300	Entrance door assemblies modeled by type to include the following: Specific door panels and frames (if applicable). Operation is specified. Spatial requirements for operation may be modeled if required by BXP.	
350	Major framing elements are modeled at jambs and head. Thresholds Operation or mechanism enclosures are modeled. All connections and interfaces modeled including brackets and supports.	
400	Complete mullion extrusion profiles Actual panel size dimensions.	

B2050.20 21-02 20 50 20 Exterior Utility Doors

Includes: Exterior personnel door assemblies other than at main entrances.

Associated Masterformat Sections: 08 10 00



Unifomat Omniclass

100	See B20	
200	See B2050	
300	See B2050.10	
350	See B2050.10	
400	All connections and interfaces modeled including brackets, supports, sealants, and thresholds.	

B2050.30 21-02 20 50 30 Exterior Oversize Doors

Includes: Large exterior door assemblies to allow for passage of large objects involving various operating methods. Includes Exterior Door Supplementary Components as appropriate including operators and drive mechanisms.

Associated Masterformat Sections: 08 33 00 / 08 36 00 / 08 36 13 / 08 36 16 / 08 36 19
08 36 23 / 08 34 16

100	See B20	
200	See B2050	
300	Oversize door assemblies modeled by type to include the following: Door panels with nominal dimensions. Frames with nominal dimensions. Clearance zones are modeled or accommodated by model checking software for operation of overhead doors (other than coiling doors). Enclosures and motor housings are modeled with overall nominal dimensions.	
350	Major framing elements in wall are modeled at jambs and head. Attachment elements are modeled	
400	All connections and interfaces modeled including brackets, supports, sealants, and thresholds.	

B2050.40 21-02 20 50 40 Exterior Special Function Doors

Includes: Exterior door assemblies for a variety of special functions and applications involving a variety of operating methods. Includes Exterior Door Supplementary Components as appropriate including controls and operators.

Associated Masterformat Sections: 08 30 00 / 08 34 13 / 08 34 19 / 08 34 46 / 08 34 49
08 34 53 / 08 34 63 / 08 34 73 / 08 38 00 / 08 39 00 / 08 88 49 / 08 88 53 / 08 88 56

[See [B2050.20](#) or [B2050.30](#)]

B2050.60 21-02 20 50 60 Exterior Grilles

Includes: Exterior devices of open construction to provide moveable barrier to provide access through wall or other divider.



Uniformat Omniclass

Associated Masterformat Sections: 08 33 00 / 08 35 16

100	See B20	
200	See B2050	
300	Grille assemblies modeled by type to include the following: Nominal size of unit. Operation is specified.	
350	Major framing elements are modeled at jambs and head.	
400	All connections and interfaces modeled including brackets, supports, sealants, and thresholds.	

B2050.70 21-02 20 50 70 Exterior Gates

Includes: Exterior devices of solid or open construction to provide moveable barrier to provide access through wall or other divider.

Associated Masterformat Sections: 08 34 56

[See [B2050.60](#)]

B2050.90 21-02 20 70 Exterior Door Supplementary Components

Includes frames, hardware, glazing and louvers that are part of door to be included with exterior door elements above as appropriate.

These components are typically modeled as part of other assemblies listed in the tables above. Do not assign this Uniformat classification unless a supplementary component is modeled independently of another assembly.

Associated Masterformat Sections: 08 10 00 / 08 30 00 / 08 71 00 / 08 80 00 / 08 91 26

B2070 Exterior Louvers and Vents

Includes: Exterior louvers which are not an integral part of mechanical equipment, including louvers connected to ducts.

Associated Masterformat Sections: 08 90 00

100	See B20	
200	Generic model element that is indicative of approximate area and location of intended louver/vent.	

B2070.10 21-02 20 70 10 Exterior Louvers

Associated Masterformat Sections: 01 83 16 / 08 91 00

100	See B20	
200	See B2070	
300	Louver assembly modeled by type, indicative of area and location of intended louver/vent. Accurate frame and blade boundary areas.	



Unifomat Omniclass

	Opening for louver is cut from host wall	
350	Major framing elements are modeled at connection points. Connection points are modeled.	
400	All connections and interfaces modeled including brackets, supports, and sealants.	

B2070.50 21-02 20 70 50 Exterior Vents

Associated Masterformat Sections: 08 95 00

[See [B2070.10](#)]

B2080 21-02 20 80 Exterior Wall Appurtenances

Includes: Exterior enclosures, grilles and screens of wood, metal, plastic, and other materials for a variety of purposes including screening of equipment.

Associated Masterformat Sections:

[See [B2050](#)]

B2080.10 21-02 20 80 10 Exterior Fixed Grilles and Screens

Includes: Exterior enclosures, grilles and screens of wood, metal, plastic, and other materials for a variety of purposes including screening of equipment.

Associated Masterformat Sections: 05 70 00 / 06 49 00 / 06 60 00 / 06 80 00 / 10 82 13

[See [B2050.60](#)]

B2080.30 21-02 20 80 30 Exterior Opening Protection Devices

Includes: Manufactured items such as louvers, fins, shutters, demountable panels, awnings, and sun screens to provide sun control, privacy, security, insulation, and storm protection on exterior of windows, skylights, and entrances. Includes fixed and moveable, manually and electrically operated, and automatically controlled devices.

Associated Masterformat Sections: 10 71 00 / 10 71 13 / 10 71 16 / 10 73 13

[See [B2010.60](#)]

B2080.50 21-02 20 80 50 Exterior Balcony Walls and Railings

Includes: Exterior enclosures, grilles and screens of wood, metal, plastic, and other materials for a variety of purposes including screening of equipment.

Associated Masterformat Sections: 03 30 00 / 03 40 00 / 04 20 00 / 05 41 00 / 06 11 00
06 16 00 / 05 52 00 / 05 73 00 / 06 43 16 / 06 63 00 / 06 81 00

[See [B2010.50](#)]



Uniformat Omniclass

B2080.70 21-02 20 80 70 Exterior Fabrications

Includes: Exterior fabrications of a variety of materials formed to various profiles for a variety of purposes including column covers, decorative metal, ornamental woodwork, and plaster fabrications.

Associated Masterformat Sections: 03 49 00 / 05 50 00 / 05 58 13 / 05 70 00 / 06 44 00
06 60 00 / 06 61 00 / 06 80 00 / 09 27 00

[See [Fundamental LOD Definitions](#)]

B2080.80 21-02 20 80 80 Bird Control Devices

Includes: Mechanical, electrical, physical, and chemical repellent systems, and protective devices.

Associated Masterformat Sections: 10 81 13

[See [Fundamental LOD Definitions](#)]

B2090 21-02 20 90 Exterior Wall Specialties

Includes: Complete fabrication of metal, wood, and fiberglass, including accessories and appurtenances. For example, clocks, below-grade egress assemblies, and window wells.

Associated Masterformat Sections: 07 77 00 / 10 74 00 / 10 74 13 / 10 74 43 / 10 74 46

[See [Fundamental LOD Definitions](#)]

B30 21-02 30 Exterior Horizontal Enclosures

Associated Masterformat Sections: 01 83 16

100	Solid mass model representing overall building volume; or, schematic wall elements that are not distinguishable by type or material. Assembly depth/thickness and locations still flexible.	
-----	--	--

B3010 21-02 30 10 Roofing

Associated Masterformat Sections: 01 83 19

100	See B30	
200	Generic element representing roof exterior skin	
300	Specific element representing roof insulation and exterior skin modeled to actual dimensions. Surface slopes (e.g. tapered insulation) are modeled to actual dimensions. Penetrations are modeled to nominal dimensions for major wall openings such as skylights, and large mechanical elements.	
350	All penetrations are modeled at actual rough-opening dimensions. Flashing	



Uniformat Omniclass

B3010.10 21-02 30 10 10 Steep Slope Roofing

Includes: Lapped roofing shingles, shakes and roofing tiles, including fastening and flashing products and methods. Includes Roofing Supplementary Components as appropriate.

Associated Masterformat Sections: 01 83 19 / 07 30 00 / 07 31 00 / 07 32 00 / 07 41 00
07 61 00 / 07 63 00

[\[See B3010\]](#)

B3010.50 21-02 30 10 50 Low-Slope Roofing

Includes: Membrane roofing of various types and protected membrane roofing, including fastening and flashing products. Includes Roofing Supplementary Components as appropriate.

Associated Masterformat Sections: 01 83 19 / 07 50 00 / 07 55 00 / 07 55 63 / 07 76 00

[\[See B3010\]](#)

B3010.70 21-02 30 10 70 Canopy Roofing

Includes: Roofing of various types over canopies. Includes Roofing Supplementary Components as appropriate.

Associated Masterformat Sections:

[\[See B1020\]](#)

B3010.70 21-02 30 10 70 Canopy Roofing

Includes: Roofing of various types over canopies. Includes Roofing Supplementary Components as appropriate.

Associated Masterformat Sections:

[See [B3010.10](#) or [B3010.50](#)]

B3010.90 21-02 30 10 90 Roofing Supplementary Components

Includes: substrate boards, vapor retarder, air barriers, deck insulation, flashing and sheet metal, and expansion joints to be included with roofing elements above as appropriate.

These components are typically modeled as part of other assemblies listed in the tables above. Do not assign this Uniformat classification unless a supplementary component is modeled independently of another assembly.

Associated Masterformat Sections: 07 22 00 / 07 26 00 / 07 27 00 / 07 62 00 / 07 65 00
07 71 13 / 07 71 16 / 07 71 19 / 07 71 29 / 09 28 00

B3020 21-02 30 20 Roof Appurtenances

Includes: Roof specialties and accessories installed on or in roofing or traffic bearing horizontal enclosure systems. Includes components for the management of rainwater, but excludes mechanical and structural items.

Associated Masterformat Sections:

100	See B30	
200	See Fundamental LOD Definitions	



Unifomat Omniclass

B3020.10 21-02 30 20 10 Roof Accessories

Includes: Ladders, curbs, vents, walkways, and snow guards.

Associated Masterformat Sections: 05 51 33 / 07 72 00 / 07 72 13 / 07 72 23 / 07 72 26
07 72 46 / 07 72 53

100	See B30	
200	See Fundamental LOD Definitions	
300	<p>Ladders: Specific assemblies indicating length and width. Required access/clearance space is modeled or accommodated by model checking software.</p> <p>Walkways: Specific assemblies indicating length, width, and rail/guard height.</p> <p>Vents: Specific assemblies indicating roof opening size. Roof opening element is included. Required service access space is modeled or accommodated by model checking software.</p>	
350	<p>Ladders: Specific assemblies indicating length, width, and attachment/anchoring members.</p> <p>Walkways: Specific assemblies indicating length, width, rail/guard height, and support/attachment/anchoring members.</p> <p>Vents: Specific assemblies indicating roof opening size and attachment/anchoring members if applicable.</p>	
400	See Fundamental LOD Definitions	

B3020.30 21-02 30 20 30 Roof Specialties

Includes: Cupolas, spires, steeples, and weathervanes.

Associated Masterformat Sections: 10 74 00 / 10 74 23 / 10 74 26 / 10 74 29 / 10 74 33

[\[See Fundamental LOD Definitions\]](#)

B3020.70 21-02 30 20 70 Rainwater Management

Includes: Components to manage rain water from roofing and traffic bearing horizontal enclosures. Includes: Conductor heads, gutters, downspouts, scuppers, and splash blocks.

Associated Masterformat Sections: 07 71 23 / 07 71 33 / 03 48 16

[See [D2030.10](#) and [D2030.20](#)]

B3040 21-02 30 40 Traffic Bearing Horizontal Enclosures

Includes: Horizontal enclosures that are also traffic bearing. Includes Horizontal Enclosure Supplementary Components as appropriate.

Associated Masterformat Sections: 01 83 16

100	See B30	
200	See B3010	



Uniformat Omniclass

B3040.10 21-02 30 40 10 Traffic Bearing Coatings

Includes: Surface applied waterproofing exposed to weather and suitable for pedestrian or vehicular traffic.

Associated Masterformat Sections: 07 18 00

B3040.30 21-02 30 40 30 Horizontal Waterproofing Membrane

Includes: Substrate board, deck insulation, vapor retarder, sheet metal flashing and trim, flexible flashing, and expansion joints.

Associated Masterformat Sections: 07 10 00

100	See B30	
200	See B3040	
300	Membrane assembly modeled by type to specified thickness. Major openings such as shafts and hatches are modeled.	
350	Individual material layers of membrane assembly are modeled separately. All openings and penetrations are modeled. Expansion joints are modeled indicating specific width.	

B3040.50 21-02 30 40 50 Wear Surfaces

Includes: Wearing surfaces on top of horizontal waterproofing membrane that are suitable for pedestrian or vehicular traffic.

Associated Masterformat Sections: 07 76 00 / 32 13 00 / 32 14 00

100	See B30	
200	See B3040	
300	Wear surface system modeled by type to specified thickness/depth. Major openings such as shafts and hatches are modeled.	
350	Individual system elements are modeled separately. Pedestals are modeled and located properly, if applicable. Expansion joints are modeled indicating specific width.	

B3040.90 21-02 30 40 90 Horizontal Enclosure Supplementary Components

Includes: Substrate board, deck insulation, vapor retarder, sheet metal flashing and trim, flexible flashing, and expansion joints to be included with horizontal enclosure elements above as appropriate.

These components are typically modeled as part of other assemblies listed in the tables above. Do not assign this Uniformat classification unless a supplementary component is modeled independently of another assembly.

Associated Masterformat Sections: 07 20 00 / 07 26 00 / 07 62 00 / 07 65 00 / 07 71 13
07 71 16 / 07 71 19 / 07 71 29 / 09 28 00



Uniformat Omniclass

B3060 21-02 30 60 Horizontal Openings

Includes: Openings in horizontal enclosures including roofing and traffic bearing horizontal enclosures. Includes Horizontal Opening Supplementary Components as appropriate.

Associated Masterformat Sections:

100	See B30	
200	See B2020	

B3060.10 21-02 30 60 10 Roof Windows and Skylights

Includes: Operable and non-operable roof windows. Includes: Skylights without framing with plastic and glass glazing. Includes: Skylights with framing.

Associated Masterformat Sections: 01 83 16 / 08 60 00 / 08 61 00 / 08 62 00 / 08 63 00
08 64 00 / 08 67 00

[See [B2020.10](#)]

B3060.50 21-02 30 60 50 Vents and Hatches

Includes: Other roof openings such as roof hatches, smoke vents, and gravity roof ventilators.

Associated Masterformat Sections: 07 72 33 / 07 72 36

[See [B3020.10](#)]

B3060.90 21-02 30 60 90 Horizontal Opening Supplementary Components

Includes: Frames, hardware, glazing, flashing, and joint sealants to be included with horizontal opening elements above as appropriate.

These components are typically modeled as part of other assemblies listed in the tables above. Do not assign this Uniformat classification unless a supplementary component is modeled independently of another assembly.

Associated Masterformat Sections: 08 75 00 / 08 80 00 / 07 60 00 / 07 92 00

B3080 21-02 30 80 Overhead Exterior Enclosures

Includes: Exposed to weather construction under horizontal enclosure construction. Includes suspension and support systems, insulation, vapor retarders, and air barriers.

Associated Masterformat Sections: 01 83 16

100	See B30	
200	Generic assemblies indicative of overall scope and approximate thickness/system depth of overhead enclosure.	

B3080.10 21-02 30 80 10 Exterior Ceilings

Associated Masterformat Sections: 07 42 00 / 07 44 00 / 09 20 00 / 09 54 00 / 09 56 00
09 90 00

100	See B30	
200	See B3080	



Unifomat Omniclass

300	Overall assembly modeled to specific system thickness including structural backing. Location of expansion or control joints indicated, but not modeled.	
350	Face material modeled to specific thickness. Structural backing members including bracing/lateral framing/kickers are modeled. Expansion or control joints are modeled to indicate specific width.	
400	Individual elements of face material are modeled. Structural backing members and all support members (kickers) are modeled including all connections. Expansion or control joints are modeled.	

B3080.20 21-02 30 80 20 Exterior Soffits

Associated Masterformat Sections: 07 42 93 / 07 44 00 / 08 95 13 / 09 20 00 / 09 54 00
09 56 00 / 09 90 00

[See [B3080.10](#)]

B3080.30 21-02 30 80 30 Exterior Bulkheads

Associated Masterformat Sections: 07 42 00 / 07 44 00 / 09 20 00 / 09 54 00 / 09 56 00
09 90 00

[See [B3080.10](#)]



Unifomat Omniclass

C 21-03 INTERIORS

Associated Masterformat Sections: 01 84 00

C10 21-03 10 Interior Construction

Associated Masterformat Sections: 01 84 13

100	<p>A schematic model element or symbol that is not distinguishable by type or material.</p> <p>Types, layouts, and locations are still flexible.</p>	
-----	--	--

C1010 21-03 10 10 Interior Partitions

Includes: Enclosures and partitions which are fixed and secured in place. Includes walls of concrete; and masonry; and wood and metal stud partitions with associated wall surfaces. Includes partitions of an open nature, such as wire mesh partitions. Partitions may be load bearing or non-load bearing. Includes Interior Partition Supplementary Components as appropriate.

Associated Masterformat Sections: 10 22 00 / 01 84 13

100	See C10	
200	<p>Generic wall objects separated by type of material (e.g. gypsum board vs. masonry).</p> <p>Approximate overall wall thickness represented by a single assembly.</p> <p>Layouts, locations, heights, and elevation profiles are still flexible.</p>	

C1010.10 21-03 10 10 10 Interior Fixed Partitions

Includes: Enclosures and partitions which are fixed and secured in place. Includes walls of concrete; and masonry; and wood and metal stud partitions with associated wall surfaces. Includes partitions of an open nature, such as wire mesh partitions. Partitions may be load bearing or non-load bearing. Includes Interior Partition Supplementary Components as appropriate.

Associated Masterformat Sections: 03 30 00 / 03 40 00 / 04 20 00 / 05 41 00 / 06 11 00 / 09 20 00 / 10 22 13

100	See C10	
200	See C1010	
300	<p>Composite model assembly by type with overall thickness that accounts for framing and finish specified for the wall system. (Refer to LOD350 and LOD400 for individually modeled elements)</p> <p>Wall elements are modeled to specific layouts, locations, heights, and elevation profiles. Penetrations are modeled to nominal dimensions for major wall openings such as windows, doors, and large mechanical elements.</p>	



Unifomat Omniclass

350	<p>Structure and finish layers of partition assembly modeled as separate elements.</p> <p>All penetrations are modeled at actual rough-opening dimensions.</p> <p>Major framing elements such as king studs, kickers, diagonal bracing, and headers are modeled.</p>	
400	<p>Element modeling to include:</p> <ul style="list-style-type: none"> • Studs and tracks • Bracing • Insulation • Sheathing or wall boards • Openings/penetrations 	

C1010.10.10 21-03 10 10 10 10 Interior Wall (Masonry)

Includes: Enclosures and partitions which are fixed and secured in place. Includes walls of concrete; and masonry; and wood and metal stud partitions with associated wall surfaces. Includes partitions of an open nature, such as wire mesh partitions. Partitions may be load bearing or non-load bearing. Includes Interior Partition Supplementary Components as appropriate.

Associated Masterformat Sections: 10 22 00 / 01 84 13

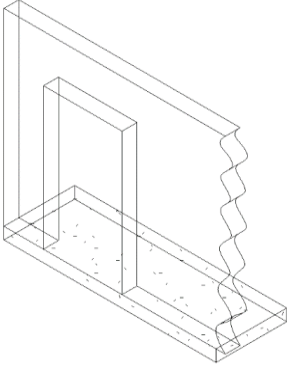
100	See C10	
200	See C1010	 <p>85 C1010.04-LOD-200 Interior Wall (Masonry)</p>

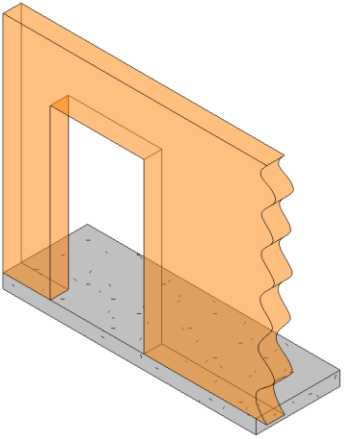
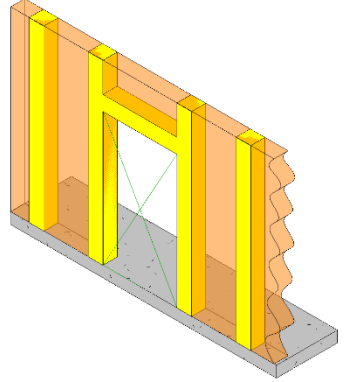

Unifomat Omniclass

300	See C1010.10	 <p>86 C1010.04-LOD-300 Interior Wall (Masonry), From lkerd.com</p>
350	Element modeling to include: <ul style="list-style-type: none">• Members modeled at any interface with wall edges (top, bottom, sides) or opening through wall• All penetrations are modeled at actual rough-opening dimensions.• Any regions that would impact coordination with other systems such as but not limited to:<ul style="list-style-type: none">○ Bond Beam & Lintel Regions○ Reinforcing & Embed Regions○ Jam Regions	 <p>87 C1010.04-LOD-350 Interior Wall (Masonry) From lkerd.com</p>

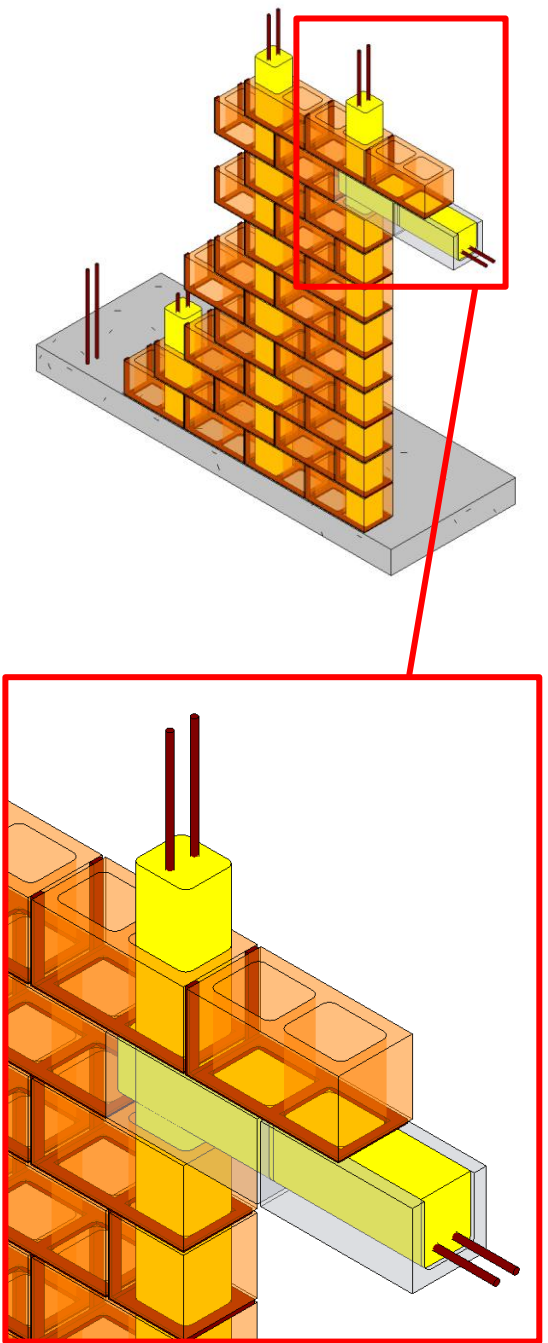

Unifomat Omniclass

<p>400</p>	<p>Element modeling to include:</p> <ul style="list-style-type: none">• Reinforcing• Connections• Grouting Material• Jams• Bond Beams• Lintels• Member fabrication part number• Any part required for complete installation	 <p>88 C1010.04-LOD-400 Interior Wall (Masonry) From lkerd.com</p>
------------	--	--



Uniformat Omniclass

C1010.10.20 21-03 10 10 10 20 Interior Wall (Cold-Form Metal Framing)

Includes: Enclosures and partitions which are fixed and secured in place. Includes walls of concrete; and masonry; and wood and metal stud partitions with associated wall surfaces. Includes partitions of an open nature, such as wire mesh partitions. Partitions may be load bearing or non-load bearing. Includes Interior Partition Supplementary Components as appropriate.

Associated Masterformat Sections: 10 22 00 / 01 84 13

100	See C10	
-----	-------------------------	--

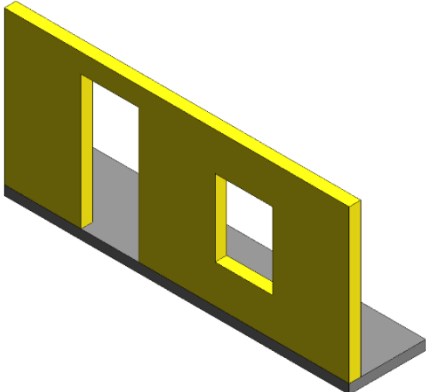
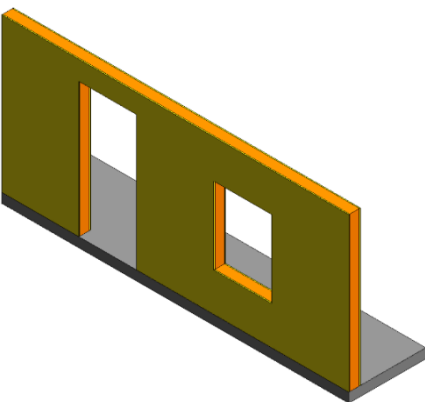

Unifomat Omniclass

200	See C1010	 <p>89 C1010.05-LOD-200 Interior Wall (Cold-Form Metal Framing), From lkerd.com</p>
300	See C1010.10 C1010.10	 <p>90 C1010.05-LOD-300 Interior Wall (Cold-Form Metal Framing), From lkerd.com</p>

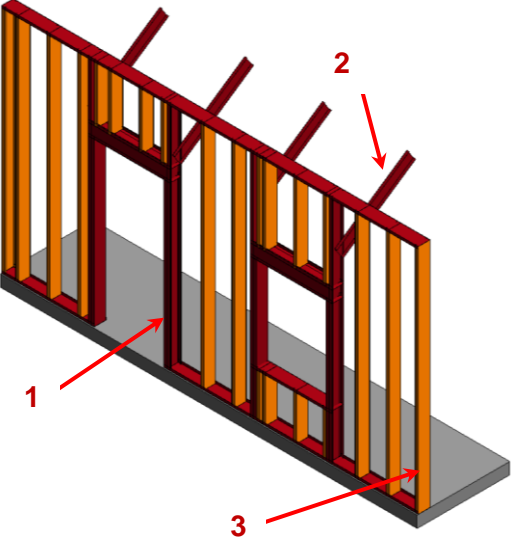

Unifomat Omniclass

<p>350</p>	<p>Cold formed metal framing is developed with sufficient elements to support detailed interface coordination with other systems such as MEP.</p> <p>All penetrations are modeled at actual rough-opening dimensions.</p> <p><i>Image notes:</i></p> <ul style="list-style-type: none">• <i>Elements in red are critical wall support elements that cannot be easily cut for coordination of MEP opening through the walls.</i>• <i>Diagonal bracing (kickers) that may be in the above ceiling space are modeled for coordination with other building content such as MEP passing along the wall in the above ceiling spaces.</i>• <i>Infill CFMF modeling (Orange) may be omitted at this LOD if stated in the BXP.</i>• <i>Cladding and sheathing are not shown for clarity in this image.</i>	 <p>91 C1010.05-LOD-350 Interior Wall (Cold-Form Metal Framing), From lkerd.com</p>
------------	--	--

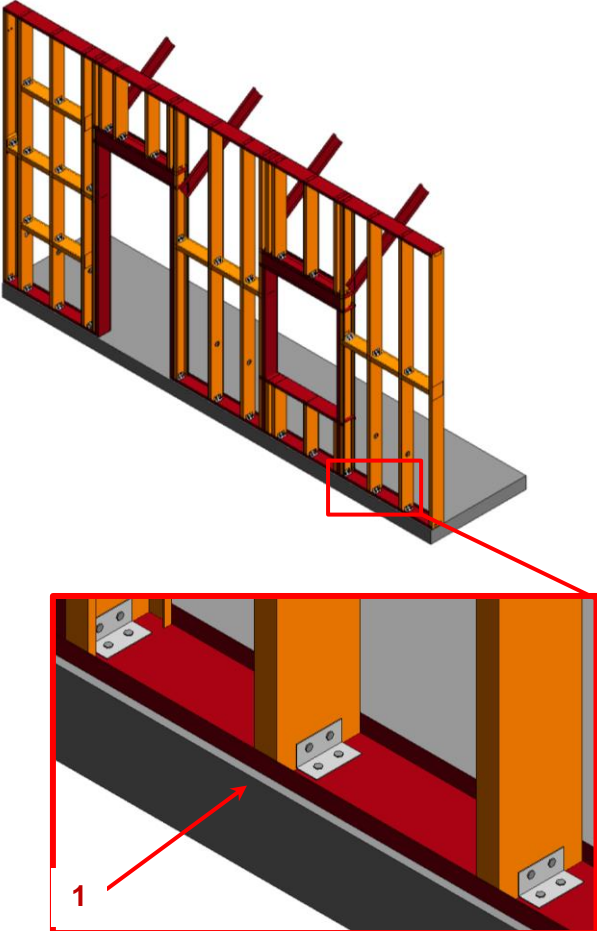

Unifomat Omniclass

<p>400</p> <p>Cold formed metal framing is developed with sufficient elements that support the fabrication of the CFMF system.</p> <p><i>Image notes:</i></p> <ol style="list-style-type: none"> 1) Connection content is development in the wall elements. This includes but is not limited to fasteners, clips, and other related hardware. 2) Cladding and sheathing are not shown for clarity in this image. 	 <p>92 C1010.05-LOD-400 Interior Wall (Cold-Form Metal Framing), From lkerd.com</p>
--	---

C1010.10.30 21-03 10 10 10 30 Interior Wall (Wood)

Includes: Enclosures and partitions which are fixed and secured in place. Includes walls of concrete; and masonry; and wood and metal stud partitions with associated wall surfaces. Includes partitions of an open nature, such as wire mesh partitions. Partitions may be load bearing or non-load bearing. Includes Interior Partition Supplementary Components as appropriate.

Associated Masterformat Sections: 10 22 00 / 01 84 13

100	See C10	
-----	-------------------------	--

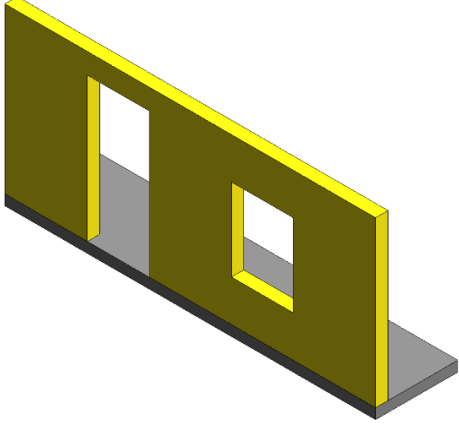
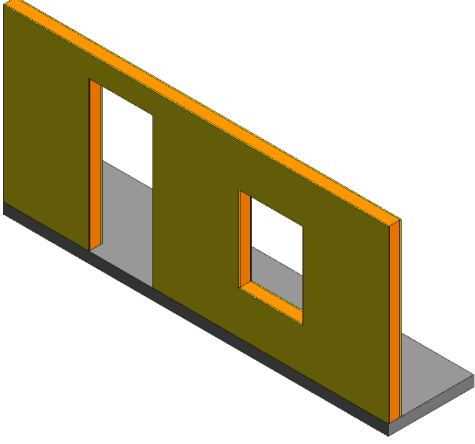

Unifomat Omniclass

200	See C1010	 <p>93 C1010.06-LOD-200 Interior Wall (Wood), From lkerd.com</p>
300	See C1010	 <p>94 C1010.06-LOD-300 Interior Wall (Wood), From lkerd.com</p>

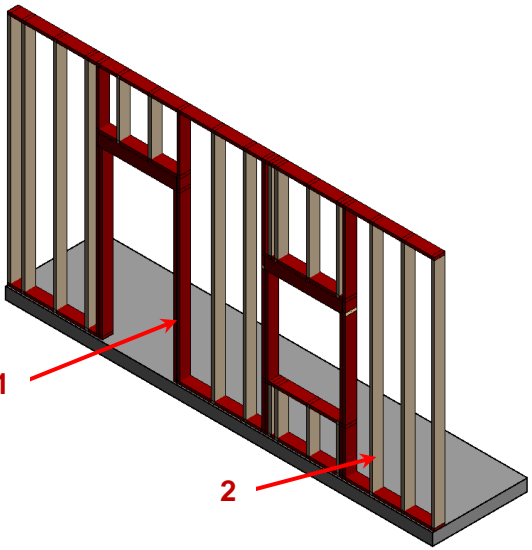
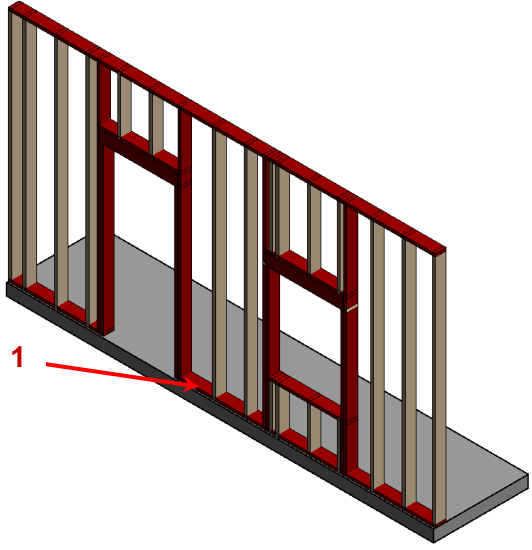

Unifomat Omniclass

<p>350</p>	<p>Wood framing is developed with sufficient elements to support detailed interface coordination with other systems such as MEP.</p> <p>All penetrations are modeled at actual rough-opening dimensions.</p> <p><i>Image notes:</i></p> <ol style="list-style-type: none">1) Elements in red are critical wall support elements that cannot be easily cut for coordination of MEP opening through the walls.2) Infill wood framing modeling may be omitted at this LOD if stated in the BXP.3) Cladding and sheathing are not shown for clarity in this image.	 <p>95 C1010.06-LOD-350 Interior Wall (Wood), From lkerd.com</p>
<p>400</p>	<p>Wood framing is developed with sufficient elements that support the fabrication of the wood framing system.</p> <p>Openings and penetrations through studs are modeled.</p> <p><i>Image notes:</i></p> <ol style="list-style-type: none">1) Connection content is development in the wall elements. This includes but is not limited to fasteners, anchor rods, and other related hardware.2) Cladding and sheathing are not shown for clarity in this image.	 <p>96 C1010.06-LOD-400 Interior Wall (Wood), From lkerd.com</p>



Unifomat Omniclass

C1010.20 21-03 10 10 20 Interior Glazed Partitions

Includes: Partitions primarily composed of glazed elements that may be fabricated or field constructed. Includes Interior Partition Supplementary Components as appropriate.

Associated Masterformat Sections: 08 43 00

100	See C10	
200	See C1010	
300	Specified location and orientation of face of glass. Nominal face dimensions and thickness of glazing. Structural support systems of wall to be modeled. Spacing, location, size and orientation of mullions. Operable components defined (doors) and included in model.	
350	<ul style="list-style-type: none"> Mullion shapes and geometry defined. Actual anchorage layouts and types defined. Actual panel dimensions (including seating). 	
400	<ul style="list-style-type: none"> Complete mullion extrusion profiles. Interface details between wall systems (within) and wall and support systems. 	

C1010.40 21-03 10 10 40 Interior Demountable Partitions

Associated Masterformat Sections: 10 22 19 / 01 84 13 / 10 22 19.13 / 10 22 19.23 / 10 22 19.33
10 22 19.43 / 10 22 19.53

100	See C10	
200	See C1010	
300	See C1010.10	
350	See C1010.10 – also include hardware, accessories, and support structure.	
400	See C1010.10	

C1010.50 21-03 10 10 50 Interior Operable Partitions

Includes: Track-supported, operable panels and partitions, top hung and floor supported, and manually and power operated. Includes auditorium partitions and dividers. Includes overhead supports.

Associated Masterformat Sections: 01 84 13 / 01 84 13 / 10 22 33 / 10 22 36 / 10 22 39
10 22 43

100	See C10	
200	See C1010	



Uniformat Omniclass

300	Operable partition system modeled to include spatial requirements for open/storage position and closed position. Spatial requirements for structure (overhead or below) to be modeled.	
350	Major support elements (overhead or below) Mechanical connections	
400	All assembly components including tracks, panels, hardware and supports.	

C1010.70 21-03 10 10 70 Interior Screens

Portable and open dividers.

Associated Masterformat Sections: 10 22 23 / 10 82 23

[See [C1010.10](#)]

C1010.90 21-03 10 10 90 Interior Partitions Supplementary Components

Sound isolation components, firestopping, and expansion control to be included with interior partition elements above as appropriate.

These components are typically modeled as part of other assemblies listed in the tables above. Do not assign this Uniformat classification unless a supplementary component is modeled independently of another assembly.

Associated Masterformat Sections: 13 48 00 / 09 81 00 / 07 84 00 / 07 95 00

C1020 21-03 10 20 Interior Windows

Includes: Interior fixed or operable windows used singly and in multiples. Includes Interior Window Supplementary Components as appropriate. Includes metal, wood, plastic, and composite window units.

Associated Masterformat Sections: 08 50 00 / 01 84 13

100	See C10	
200	Windows approximate in terms of location, size, count and type. Units are modeled as a simple, monolithic component; or represented with simplified frame and glazing. Nominal unit size is provided.	

C1020.10 21-03 10 20 10 Interior Operating Windows

Includes: Interior fixed or operable windows used singly and in multiples. Includes Interior Window Supplementary Components as appropriate. Includes metal, wood, plastic, and composite window units.

Associated Masterformat Sections: 08 50 00

100	See C10	
200	See C1020	



Unifomat Omniclass

300	<p>Units are modeled based on specified location and nominal size. Outer geometry of window frame elements and glazing modeled.</p> <p>Operation is indicated.</p> <p>Non-graphic information associated with model element:</p> <p>Aesthetic characteristics (finishes, glass types) Performance characteristics (i.e. U-value, wind loading, blast resistance, structural, air, thermal, water, sound) Functionality of the window (fixed, casement, double/single hung, awning/project out, pivot, sliding)</p>	
350	<p>Attachment method of window to structure</p> <p>Embed geometry</p>	
400	<p>Frame profiles</p> <p>Glazing sub-components (gaskets)</p> <p>Attachment components</p>	

C1020.20 21-03 10 20 20 Interior Fixed Windows

Includes: Interior fixed or operable windows used singly and in multiples. Includes Interior Window Supplementary Components as appropriate. Includes metal, wood, plastic, and composite window units.

Associated Masterformat Sections: 08 50 00

C1020.50 21-03 10 20 50 Interior Special Function Windows

Includes interior windows with special characteristics for a special function.

Associated Masterformat Sections: 08 56 00 / 08 56 19 / 08 56 46 / 08 56 49 / 08 88 49 / 08 56 53 / 08 88 53 / 08 88 56 / 08 56 63 / 08 56 73

C1020.90 21-03 10 20 90 Interior Window Supplementary Components

Includes: Frames, sills, operating hardware, glazing to be included with interior window elements above as appropriate.

These components are typically modeled as part of other assemblies listed in the tables above. Do not assign this Unifomat classification unless a supplementary component is modeled independently of another assembly.

Associated Masterformat Sections: 08 75 00 / 08 80 00

C1030 21-03 10 30 Interior Doors

Includes: Interior door assemblies. Includes metal doors and frames, wood doors and frames, plastic doors, and composite doors. Includes Interior Door Supplementary Components as appropriate.

Associated Masterformat Sections: 08 10 00 / 01 84 13

100	See C10	
200	Units are modeled as a simple, monolithic component; or represented with simple frame and panel.	



Unifomat Omniclass

	Nominal unit size is provided.	
--	--------------------------------	--

C1030.10 21-03 10 30 10 Interior Swinging Doors

Includes: Interior door assemblies. Includes metal doors and frames, wood doors and frames, plastic doors, and composite doors. Includes Interior Door Supplementary Components as appropriate.

Associated Masterformat Sections: 08 10 00

100	See C10	
200	See C1030	
300	Door assemblies modeled by type to include the following: <ul style="list-style-type: none"> • Specific door panels and frames (if applicable). • Operation is specified 	
350	Major framing elements are modeled at jambs and head in containing wall. Operation or mechanism enclosures are modeled, if applicable.	
400	Actual frame/mullion extrusions. Actual panel size dimensions. All connections and interfaces modeled including brackets, supports, sealants, and thresholds.	

C1030.20 21-03 10 30 20 Interior Entrance Doors

Includes: Exterior personnel door assemblies at interior main entrances. Includes automatic, revolving, balanced, and other special operating entrance doors, and sliding storefront wall systems. Includes Interior Door Supplementary Components as appropriate when not part of storefront system.

Associated Masterformat Sections: 08 42 00 / 08 42 26 / 08 42 29 / 08 42 33 / 08 42 36
08 43 29

[See [B2050.10](#)]

C1030.25 21-03 10 30 25 Interior Sliding Doors

Associated Masterformat Sections: 08 11 73 / 08 32 00

[See [C1030.10](#)]

C1030.30 21-03 10 30 30 Interior Folding Doors

Associated Masterformat Sections: 08 35 13

[See [C1030.10](#)]

C1030.40 21-03 10 30 40 Interior Coiling Doors

Associated Masterformat Sections: 08 33 00 / 08 33 13

100	See C10	
-----	-------------------------	--



Uniformat Omniclass

200	See C1030	
300	Coiling door assemblies modeled by type to include the following: <ul style="list-style-type: none"> • Door panels with nominal dimensions. • Frames with nominal dimensions. • Hardware set functionality and types included in non-graphic information. • Clearance zones for operation of overhead doors are modeled or accommodated by model checking software. • Enclosures and motor housings are modeled with overall nominal dimensions. 	
350	Major framing elements in wall are modeled at jambs and head. Other major structural support elements are modeled.	
400	All connections and interfaces modeled including brackets, supports, sealants, and thresholds.	

C1030.50 21-03 10 30 50 Interior Panel Doors

Includes: Interior large opening doors constructed of panels that move.

Associated Masterformat Sections: 08 36 00 / 08 36 13 / 08 36 16 / 08 36 19 / 08 36 23

[See [C1030.40](#)]

C1030.70 21-03 10 30 70 Interior Special Function Doors

Includes: Interior door assemblies for a variety of special functions and applications involving a variety of operating methods. Includes Interior Door Supplementary Components as appropriate.

Associated Masterformat Sections: 08 30 00. / 08 34 13 / 08 34 19 / 08 34 33 / 08 34 36
08 34 46 / 08 34 49 / 08 88 49 / 08 34 53 / 08 42 33.13 / 08 88 53 / 08 88 56 / 08 34 59
08 34 63 / 08 34 73 / 08 38 00 / 08 39 00

[See [C1030.40](#)]

C1030.80 21-03 10 30 80 Interior Access Doors and Panels

Includes: Doors and panels in walls, ceilings, and floors to provide access to concealed spaces. Includes frames and hardware.

Associated Masterformat Sections: 08 31 00

[See [C1030.40](#)]

C1030.90 21-03 10 30 90 Interior Door Supplementary Components

Includes: Frames, hardware, glazing, and louvers that are part of door to be included with interior door elements above as appropriate.

These components are typically modeled as part of other assemblies listed in the tables above. Do not assign this Uniformat classification unless a supplementary component is modeled independently of another assembly.

Associated Masterformat Sections: 08 10 00 / 08 30 00 / 08 71 00 / 08 80 00 / 08 91 26



Unifomat Omniclass

C1040 21-03 10 40 Interior Grilles and Gates

Includes: Interior operable grilles and gates Includes frames and hardware.

100	See C10	
200	See C1030	

C1040.10 21-03 10 40 10 Interior Grilles

Associated Masterformat Sections: 08 11 74 / 08 33 00 / 08 35 16

100	See C10	
200	See C1030	
300	Grille assemblies modeled by type to include the following: <ul style="list-style-type: none"> Nominal size of unit. Required openness provided as non-graphic information. Operation is specified graphically. 	
350	Major framing elements are modeled at jambs and head.	
400	All connections and interfaces modeled including brackets, supports, sealants, and thresholds.	

C1040.50 21-03 10 40 50 Interior Gates

Includes: Interior devices of solid or open construction, usually hinged, to provide moveable barrier for access through partition or other divider. Includes hardware, accessories, and finishing.

Associated Masterformat Sections: 08 34 56 / 10 22 16

[See [C1040.10](#)]

C1060 21-03 10 60 Raised Floor Construction

Associated Masterformat Sections: 01 84 13 / 01 84 13 / 01 84 13 / 01 84 13 / 01 84 13
01 84 13 / 01 84 13 / 01 84 13 / 01 84 13

100	See C10	
200	Generic assembly that contains spatial allowance for support system and flooring material.	

C1060.10 21-03 10 60 10 Access Flooring

Includes: Free-standing, elevated accessible floor assembly forming an underfloor cavity that may be used for utility or other purposes.

Associated Masterformat Sections: 09 69 00



Unifomat Omniclass

100	See C10	
200	See C1060	
300	Overall flooring assembly modeled by type to specified thickness/depth. Major openings such as shafts are modeled.	
350	Individual layers of assembly are modeled separately. All openings and penetrations are modeled. Expansion joints are modeled indicating specific width. Pedestals are modeled and located properly, if applicable.	
400	All assembly components are modeled including frame, floor tiles, pedestals, and cross bracing.	

C1060.30 21-03 10 60 30 Platform/Stage Floors

Includes: Fixed construction of raised floor for platforms or stages.
[See [C1060.10](#)]

C1070 21-03 10 70 Suspended Ceiling Construction

Includes: Ceiling Suspension Components.

Associated Masterformat Sections: 01 84 13 / 01 84 13

100	Ceiling construction is represented in other composite objects such as floors or rooms; or, schematic model elements that are not distinguishable by type or material. Assembly depth/thickness and locations still flexible.	
200	Generic assemblies indicative of overall scope and approximate thickness/system depth of suspended ceiling.	

C1070.10 21-03 10 70 10 Acoustical Suspended Ceilings

Includes: Suspended tiles and panels with specific characteristics for acoustical purposes.

Associated Masterformat Sections: 09 51 00 / 09 81 00

100	See C1070	
200	See C1070	
300	Overall assembly modeled to specific system thickness including structural backing. Location of expansion or control joints indicated, but not modeled.	



Uniformat Omniclass

	Ceiling grid is shown as linework.	
350	Ceiling suspension grid is modeled. Structural backing members including bracing/lateral framing/kickers are modeled. Expansion or control joints are modeled to indicate specific width.	
400	All assembly components are modeled including tees, hangers, support structure, and tiles.	

C1070.20 21-03 10 70 20 Suspended Plaster and Gypsum Board Ceilings

Includes: Suspended assemblies with plaster and gypsum board surfaces.

Associated Masterformat Sections: 09 20 00 / 09 22 26 / 09 81 00

100	See C1070	
200	See C1070	
300	Overall assembly modeled to specific system thickness including framing. Bulkheads Major penetrations are modeled.	
350	Major bracing elements such as kickers are modeled.	
400	All assembly components including furring channels, hangers, lath, plaster coats, and gypsum boards.	

C1070.50 21-03 10 70 50 Specialty Suspended Ceilings

Includes: Suspended specialty ceiling panels, units, and materials manufactured as finished

Associated Masterformat Sections: 09 54 00 / 09 56 00

[See [C1070.10](#) or [C1070.20](#)]

C1070.70 21-03 10 70 70 Special Function Suspended Ceilings

Includes: Suspended ceiling assemblies with an additional special function including integrated ceiling assemblies.

Associated Masterformat Sections: 09 57 00 / 09 57 53 / 09 58 00

[See [C1070.10](#) or [C1070.20](#)]

C1070.90 21-03 10 70 90 Ceiling Suspension Components

Includes: Hangers and framing to suspend ceiling and sound isolation components to be included with suspended ceiling construction elements above as appropriate.

These components are typically modeled as part of other assemblies listed in the tables above. Do not assign this Uniformat classification unless a supplementary component is modeled independently of another assembly.



Unifomat Omniclass

Associated Masterformat Sections: 13 48 00

C1090 21-03 10 90 Interior Specialties

100	See C10	
200	Generic model elements with approximate nominal size. Placement and quantity remains flexible.	

C1090.10 21-03 10 90 10 Interior Railings and Handrails

Includes: Complete interior railing assemblies of various types including glazed railings.

Associated Masterformat Sections: 01 84 00 / 01 84 00 / 01 84 00 / 01 84 00 / 05 52 00
05 73 00 / 06 43 16 / 06 63 00 / 06 81 00

100	See C10	
200	Generic model element representing approximate overall height and location of railing/handrail.	
300	Railing/handrail systems modeled by type to include: <ul style="list-style-type: none"> All horizontal rails All vertical posts/balusters 	
350	Mounting/attachment components	
400	All assembly components including fasteners and supports.	

C1090.15 21-03 10 90 15 Interior Louvers

Includes: Interior louvers, and other items for ventilation which are not an integral part of the mechanical system. Includes operable and stationary louvers.

Associated Masterformat Sections: 08 91 00 / 01 84 00

100	See C10	
200	Generic model element that is indicative of approximate area and location of louver.	
300	Louver assembly modeled by type, indicative of area and location of intended louver/vent. Accurate frame and blade boundary areas Opening for louver is cut from host wall.	
350	Rough opening is modeled in containing wall. Major framing elements are modeled at jambs and head. Connection points are modeled.	



Uniformat Omniclass

400	All connections and interfaces modeled including brackets, supports, and sealants.	
-----	--	--

C1090.20 21-03 10 90 20 Information Specialties

Includes: Visual display units, display cases, directories, interior signage, telephone specialties, and informational kiosks.

Associated Masterformat Sections: 10 10 00 / 10 11 00 / 10 11 13 / 10 11 16 / 10 11 23
10 11 33 / 10 11 36 / 10 11 39 / 10 11 43 / 10 11 46 / 10 12 00 / 10 13 00 / 10 14 00 10 17 00 / 10 18 00

[See [Fundamental LOD Definitions](#)]

C1090.25 21-03 10 90 25 Compartments and Cubicles

Includes: Manufactured compartments and cubicles for specific purposes. Includes toilet compartments, shower stalls, etc.

Associated Masterformat Sections: 10 21 00 / 10 21 13 / 10 21 16 / 10 21 23 / 10 28 19

[See [Fundamental LOD Definitions](#)]

C1090.30 21-03 10 90 30 Service Walls

Includes: Wall assemblies and wall-mounted units incorporating services.

Associated Masterformat Sections: 10 25 00 / 10 25 13 / 10 25 16

[See [C1010.10](#)]

C1090.35 21-03 10 90 35 Wall and Door Protection

Includes: Manufactured protective devices for walls and doors. Includes corner guards, bumper guards, and protective wall covering.

Associated Masterformat Sections: 10 26 00 / 10 26 13 / 10 26 16 / 10 26 23 / 10 26 33

[See [Fundamental LOD Definitions](#)]

C1090.40 21-03 10 90 40 Toilet, Bath and Laundry Accessories

Includes: Manufactured items for use in conjunction with toilets, baths, and laundries.

Associated Masterformat Sections: 10 28 00 / 10 28 13 / 10 28 16 / 10 28 23

[See [Fundamental LOD Definitions](#)]

C1090.45 21-03 10 90 45 Interior Gas Lighting

Associated Masterformat Sections: 10 84 16

[See [Fundamental LOD Definitions](#)]



Uniformat Omniclass

C1090.50 21-03 10 90 50 Fireplaces and Stoves

Includes: Masonry fireplaces and manufactured and fabricated fireplaces, stoves, chimneys, dampers, and specialties for use in construction of fireplaces and stove units.

Associated Masterformat Sections: 10 30 00 / 04 50 00 / 04 57 00 / 10 31 00 / 10 31 13
10 32 00 / 10 35 00

[See [Fundamental LOD Definitions](#)]

C1090.60 21-03 10 90 60 Safety Specialties

Includes: Accessories that provide emergency aid.

Associated Masterformat Sections: 10 40 00 / 10 41 00 / 10 43 00

[See [Fundamental LOD Definitions](#)]

C1090.70 21-03 10 90 70 Storage Specialties

Includes: Lockers, postal specialties, storage specialties, and wardrobe and closet specialties.

Associated Masterformat Sections: 10 50 00 / 10 51 00 / 10 51 53 / 10 55 00 / 10 55 23 / 10 55 91 / 10 56 00 / 10 56 29 / 10 56 33 / 10 57 00 / 10 57 13 / 10 57 33

[See [Fundamental LOD Definitions](#)]

C1090.90 21-03 10 90 90 Other Interior Specialties

Includes: Pest control devices, flags and banners, security mirrors and domes, and scales.

Associated Masterformat Sections: 10 80 00 / 10 81 00 / 10 81 16 / 10 81 19 / 10 83 00 / 08 83 00 / 10 86 00 / 10 88 00

[See [Fundamental LOD Definitions](#)]

C20 21-03 20 Interior Finishes

Associated Masterformat Sections: 01 84 19

100	Non-graphic information attached to model elements providing assumptions that are not distinguishable by type or material Types, layouts and locations are still flexible. See Part II	
-----	--	--

C2010 21-03 20 10 Wall Finishes

Includes: Wall finishes applied over solid substrates. Includes Wall Finish Supplementary Components as appropriate.

Associated Masterformat Sections: 09 70 00 / 01 84 19 / 01 84 19 / 01 84 19 / 01 84 19 / 01 84

100	See C20	
-----	-------------------------	--



Unifomat Omniclass

200	Generic materials other than sheet goods and coatings by type (e.g. tile or paneling), approximate thickness represented by a single assembly.. Layouts, patterns and locations are still flexible	
300	Single model element by type with overall thickness that accounts for finish materials based on specific types other than sheet goods and coatings (e.g. Tile type CT-1). Sheet goods and coatings may be specified in Part II related to interior partitions.	
350	Individual materials are modeled as separate elements Additional non-graphic information such as manufacturer and model number may be included. •	
400	Individual material pattern layouts, expansion/control joints, and finish edges to be modeled as separate elements.	

C2010.10 21-03 20 10 10 Tile Wall Finish

Includes: Manufactured surfacing units of impervious, vitreous, semi-vitreous, and non-vitreous materials; glazed, unglazed, conductive, and textured surfaces.

Associated Masterformat Sections: 09 30 00

[See [C2010](#)]

C2010.20 21-03 20 10 20 Wall Paneling

Includes: Covering or cladding of interior walls with paneling. Includes associated furring, fastening, and trim.

Associated Masterformat Sections: 06 42 00 / 06 25 00 / 06 26 00 / 06 64 00 / 06 83 00

[See [C2010](#)]

C2010.30 21-03 20 10 30 Wall Coverings

Includes: Wall coverings applied over solid substrates. Includes vinyl-coated fabric, vinyl and cork wall coverings; wall papers; and flexible wood sheets.

Associated Masterformat Sections: 09 72 00 / 09 74 00

[See [C2010](#)]

C2010.35 21-03 20 10 35 Wall Carpeting

Includes: Wall carpet materials and accessories.

Associated Masterformat Sections: 09 73 00

C2010.50 21-03 20 10 50 Stone Facing

Includes: Natural stone applied as an interior veneer surface.



Unifomat Omniclass

Associated Masterformat Sections: 09 75 00

[See [C2010](#)]

C2010.60 21-03 20 10 60 **Special Wall Surfacing**
Includes: Manufactured decorative interior wall surface products including plastic blocks.

Associated Masterformat Sections: 09 77 00 / 09 77 13 / 09 77 23 / 09 76 00

[See [C2010](#)]

C2010.70 21-03 20 10 70 **Wall Painting and Coating**
Includes: Interior painting and coating with transparent and opaque finishes. Includes stains, varnishes, lacquers, primers, fillers, paint removers, and waxes, and preparation of surfaces.

Associated Masterformat Sections: 09 90 00

[See [C2010](#)]

C2010.80 21-03 20 10 80 **Acoustical Wall Treatment**
Includes: Sound absorbing, reflecting, and diffusing wall units, and accessories.

Associated Masterformat Sections: 09 83 13 / 09 84 00 / 09 84 33

[See [C2010](#)]

C2010.90 21-03 20 10 90 **Wall Finish Supplementary Components**
Includes: Furring to be included with wall finish elements above as appropriate.

Associated Masterformat Sections: 06 10 00 / 09 22 13

[See [C1010](#)]

C2020 21-03 20 20 **Interior Fabrications**
Includes: Interior fabrications of a variety of materials formed to various profiles for a variety of purposes including column covers.

Associated Masterformat Sections: 03 49 00 / 05 50 00 / 05 58 13 / 05 70 00 / 06 44 00 / 06 60 00 / 06 61 00 / 06 80 00 / 09 27 00

[See [Fundamental LOD Definitions](#)]

C2030 21-03 20 30 **Flooring**
Includes: Flooring Supplementary Components as appropriate.

Associated Masterformat Sections: 09 60 00 / 01 84 19

100	See C20	
-----	-------------------------	--



Unifomat Omniclass

200	Generic materials by type (e.g. tile or coatings), approximate thickness represented by a single assembly. Layouts, patterns and locations are still flexible	
300	Single model element by type with overall thickness that accounts for materials based on specific types (e.g. Tile type CT-1).	
350	Individual materials are modeled as separate elements Additional non-graphic information such as manufacturer and model number may be included.	
400	Individual material pattern layouts, expansion/control joints, and finish edges to be modeled as separate elements.	

C2030.10 21-03 20 30 10 Flooring Treatment

Includes: Coatings and surfacings for finished floor, applied to provide a specific performance characteristic.

Associated Masterformat Sections: 09 61 00 / 09 61 13

[See C2030]

C2030.20 21-03 20 30 20 Tile Flooring

Includes: Manufactured surfacing units of impervious, vitreous, semi-vitreous, and non-vitreous materials; glazed, unglazed, conductive, abrasive, and textured surfaces. Includes wall base units.

Associated Masterformat Sections: 09 30 00

[See C2030]

C2030.30 21-03 20 30 30 Specialty Flooring

Includes: Heavy duty and other specialty flooring. Includes asphaltic plank, laminate, bamboo, leather, cork, acoustic, synthetic turf, metal, structural glass, chemical-resistant, acid resistant, conductive, and static control flooring.

Associated Masterformat Sections: 09 62 00 / 09 35 00 / 09 63 13.35 / 09 62 35 / 09 33 00 / 09 65 33 / 09 66 33 / 09 61 36 / 09 65 36

[See C2030]

C2030.40 21-03 20 30 40 Masonry Flooring

Includes: Fired clay unit masonry, cat stone, and stone flooring. Includes wall base.

Associated Masterformat Sections: 09 63 00 / 09 63 13 / 09 63 40 / 09 63 43

[See C2030]

C2030.45 21-03 20 30 45 Wood Flooring

Includes: Strip, parquet, block, and composition wood flooring.

Associated Masterformat Sections: 09 64 00

[See C2030]



Unifomat Omniclass

C2030.50 21-03 20 30 50 Resilient Flooring

Includes: Resilient tile and sheet flooring. Includes integral and applied wall bases.

Associated Masterformat Sections: 09 65 00

[See C2030]

C2030.60 21-03 20 30 60 Terrazzo Flooring

Includes: Cast-in-place, sand-cushion, monolithic, bonded and adhesively-bonded portland cement terrazzo; poured-in-place epoxy, polyester, and resinous matrix terrazzo; and precast terrazzo. Includes integral or precast wall bases, accessories, and finish sealers.

Associated Masterformat Sections: 09 66 00 / 09 66 13 / 09 66 16 / 09 66 23

[See C2030]

C2030.70 21-03 20 30 70 Fluid-Applied Flooring

Includes: Flooring applied in a viscous state.

Associated Masterformat Sections: 09 67 00 / 09 67 13 / 09 67 16 / 09 67 19 / 09 67 23 / 09 67 26

[See C2030]

C2030.75 21-03 20 30 75 Carpeting

Includes: Floor carpet materials including cushions, accessories, and wall base.

Associated Masterformat Sections: 09 68 00 / 09 68 13 / 09 68 16

[See C2030]

C2030.80 21-03 20 30 80 Athletic Flooring

Includes: Flooring for athletic purposes.

Associated Masterformat Sections: 09 64 66 / 09 65 66 / 09 67 66

[See C2030]

C2030.85 21-03 20 30 85 Entrance Flooring

Includes: Special floor surfaces at entrances.

Associated Masterformat Sections: 12 48 13 / 12 48 16 / 12 48 19 / 12 48 23 / 12 48 26

[See C2030]

C2030.90 21-03 20 30 90 Floor Supplementary Components

Includes: Furring, underlayment, and sound and vibration control to be included with flooring elements above as appropriate.

Associated Masterformat Sections: 06 10 00 / 06 16 26 / 09 60 13 / 09 62 48

[See C2030]



Unifomat Omniclass

C2040 21-03 20 40 Stair Finishes

Includes: Stair tread, riser, and landing finish of various materials.

Associated Masterformat Sections: 01 84 19

[See [C2010](#)]

C2040.20	21-03 20 40 20	Tile Stair Finish	TBD
C2040.40	21-03 20 40 40	Masonry Stair Finish 09 63 00	TBD
C2040.45	21-03 20 40 45	Wood Stair Finish 09 64 00	TBD
C2040.50	21-03 20 40 50	Resilient Stair Finish 09 65 00	TBD
C2040.60	21-03 20 40 60	Terrazzo Stair Finish 09 66 00	TBD
C2040.75	21-03 20 40 75	Carpeted Stair Finish 09 68 00	TBD

C2050 21-03 20 50 Ceiling Finishes

Includes: Finishes applied to interior ceiling substrates. Ceiling finishes may be applied to suspended ceiling construction. Includes Ceiling Finish Supplementary Components as appropriate.

Associated Masterformat Sections: 09 50 00 / 01 84 19

C2050.10	21-03 20 50 10	Plaster and Gypsum Board Finish	TBD
C2050.20	21-03 20 50 20	Ceiling Paneling	TBD
C2050.70	21-03 20 50 70	Ceiling Painting and Coating	TBD
C2050.80	21-03 20 50 80	Acoustical Ceiling Treatment	TBD
C2050.90	21-03 20 50 90	Ceiling Finish Supplementary Components	TBD



Uniformat Omniclass

D 21-04 00 00 SERVICES

Associated Masterformat Sections: 01 86 00

D10 21-04 10 Conveying

Associated Masterformat Sections: 01 85 00 / 14 00 00

100	Schematic model elements that are not distinguishable by type or material. Component sizes and locations still flexible.	
-----	---	--

D1010 21-04 10 10 Vertical Conveying Systems

Associated Masterformat Sections:

100	See D10	
200	Generic representation of the system envelope, including critical path of travel zones.	

D1010.10 21-04 10 10 10 Elevators

Includes: Passenger and freight elevators of all types, including cars, enclosures, controls, safety equipment, hoist way equipment, and elevator machinery. Includes associated metal fabrications including pit ladders.

Associated Masterformat Sections: 01 85 00 / 14 20 00 / 14 21 13 / 14 21 23 / 14 21 33 / 14 21 43 / 14 24 13 / 14 24 23 / 14 24 33 / 14 24 43 / 14 26 00 / 14 27 00 / 14 28 00

100	See D10	
-----	-------------------------	---

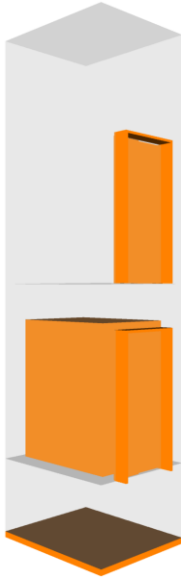
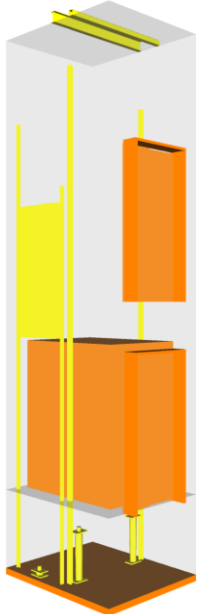

Unifomat Omniclass

<p>200</p>	<p>See D1010</p>	<p>From Kone</p>  <p>From Kone</p>
<p>300</p>	<p>Specific system elements modeled by type, including all path of travel zones.</p> <p>Pits and/or control rooms and associated equipment to be modeled if applicable.</p> <p>Major structural support elements modeled.</p> <p>Connections to mechanical or electrical services.</p>	 <p>From Kone</p>

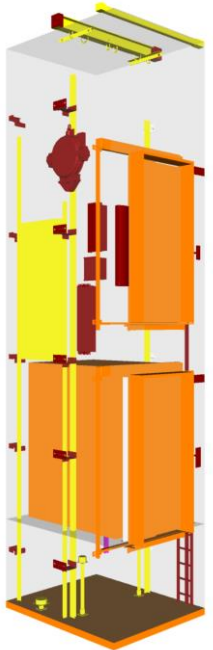
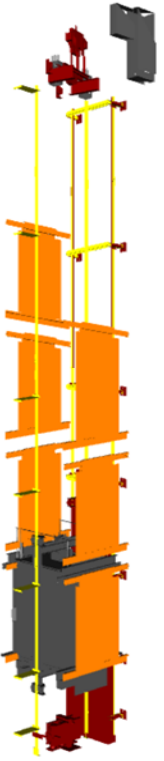

Unifomat Omniclass

<p>350</p>	<p>Sizing adjusted to the actual manufacturer specifications.</p> <p>Guiding tracks/rails</p> <p>Service/access zones</p>	 <p>From Kone</p>
<p>400</p>	<p>All connections, supports, framing, and other supplementary components.</p>	



Unifomat Omniclass

From [Kone](#)

D1010.20 21-04 10 10 20 Lifts

Includes: Vertical or inclined lifts and related equipment for a variety of purposes. Sidewalk lifts include doors.

Associated Masterformat Sections: 01 85 00 / 14 40 00 / 14 41 00 / 14 42 00 / 14 43 00
14 43 13 / 14 43 16 / 14 44 00 / 14 45 00

[See [D1010.10](#)]

D1010.30 21-04 10 10 30 Escalators

Includes: Passenger conveying systems composed of moving treads installed in inclined position including associated components, hardware, controls, safety equipment, and related items.

Associated Masterformat Sections: 01 85 00 / 14 31 00

100	See D10	
200	See D1010	
300	Specific system elements modeled by type, including all path of travel zones. Including: <ul style="list-style-type: none">• Truss Shape• Risers Balustrade Type	
350	Sizing adjusted to the actual manufacturer specifications. Fixing points of truss Clear Egress Zones Structural Clearance zones	
400	All connections, supports, framing, and other supplementary components.	

D1010.50 21-04 10 10 50 Dumbwaiters

Includes: Packaged and field assembled, motorized and hand- operated dumbwaiters including associated components for book lifts, cart lifts, and other applications. Systems include associated components, hardware, controls, and safety equipment.

Associated Masterformat Sections: 01 85 00 / 14 10 00

[See [D1010.10](#)]

D1010.60 21-04 10 10 60 Moving Ramps

Includes: Passenger conveying systems composed of moving belts installed in inclined position including associated components, hardware, controls, safety equipment, and related items.

Associated Masterformat Sections: 01 85 00 / 14 33 00



Unifomat Omniclass

[See [D1010.10](#)]

D1030 21-04 10 30 Horizontal Conveying

Associated Masterformat Sections: 01 85 00

[See [D1010.10](#)]

D1030.10 21-04 10 30 10 Moving Walks

Includes: Passenger conveying systems composed of moving belts installed in horizontal position including associated components, hardware, controls, safety equipment, and related items.

Associated Masterformat Sections: 01 85 00 / 14 32 00

[See [D1010.10](#)]

D1030.30 21-04 10 30 30 Turntables

Includes: Structural turntables for various applications.

Associated Masterformat Sections: 01 85 00 / 14 70 00 / 14 71 00 / 14 71 11 / 14 72 00 / 14 72 25 / 14 73 00 / 14 73 59 / 14 74 00 / 14 74 61

[See [D1010.10](#)]

D1030.50 21-04 10 30 50 Passenger Loading Bridges

Includes: Operating bridges for loading and unloading of passengers to and from aircraft and ships.

Associated Masterformat Sections: 01 85 00 / 34 77 13

[See [D1010.10](#)]

D1030.70 21-04 10 30 70 People Movers

Includes: Single rail vehicles suspended from or straddle the guideway. Includes associated track, equipment, controls, and accessories. Includes: Steep cable railways in which ascending cars counterbalance descending cars. Includes associated track, cable. Includes: Steep slope transportation system utilizing moving cable. Includes associated cable, support structures, equipment, controls, and accessories.

Associated Masterformat Sections: 01 85 00 / 34 12 00 / 34 13 00 / 34 14 00

[See [D1010.10](#)]

D1050 21-04 10 50 Material Handling

Associated Masterformat Sections: 01 85 00

100	See D10	
200	Generic representation of the material handling system envelope, including critical path of travel zones.	

D1050.10 21-04 10 50 10 Cranes

Includes: Hoisting towers, cranes, crane rails, and related accessories.



Unifomat Omniclass

Associated Masterformat Sections: 41 22 13

100	See D10	
200	See D1050	
300	Specific system elements modeled by type, including all path of travel/boom swing zones. Lay-down/pick-up zones are modeled. Major structural support elements modeled.. Crane Swing Radius Connections to mechanical or electrical services	
350	Sizing adjusted to the actual manufacturer specifications. Guiding tracks/rails Service/access zones Connections to mechanical or electrical services	
400	All connections, supports, framing, and other supplementary components.	

D1050.20 21-04 10 50 20 Hoists

Includes: Manual and motor operated hoists and related accessories.

Associated Masterformat Sections: 41 22 23

[See [D1050.10](#)]

D1050.30 21-04 10 50 30 Derricks

Includes: Manual and motor operated derricks and related accessories.

Associated Masterformat Sections: 41 22 33

[See [D1050.10](#)]

D1050.40 21-04 10 50 40 Conveyors

Includes: Automatic guided vehicles, conveyors, diverters, and chutes. Includes controls and accessories.

Associated Masterformat Sections: 41 21 00

[See [D1050.10](#)]

D1050.50 21-04 10 50 50 Baggage Handling Equipment

Includes: Operating equipment for handling, scanning, and weighing of baggage at terminals. Includes controls and accessories.

Associated Masterformat Sections: 34 77 16

100	See D10	
200	See D1050	
300	See Fundamental LOD Definitions	



Unifomat Omniclass

350	See Fundamental LOD Definitions	
400	See Fundamental LOD Definitions	

D1050.60 21-04 10 50 60 Chutes

Includes: Chutes which support the operation of the building or structure.

Associated Masterformat Sections: 14 91 00 / 14 91 13 / 14 91 23 / 14 91 33 / 14 91 82

[See [D1050.10](#)]

D1050.70 21-04 10 50 70 Pneumatic Tube Systems

Includes: Pneumatically operated tube system for the delivery of small items within a facility. Includes controls and accessories.

Associated Masterformat Sections: 14 92 00

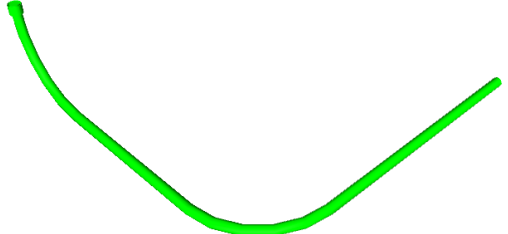
100	Diagrammatic elements or quantitative call outs; conceptual and/or schematic flow diagrams;	 <p>97 D1050.70-LOD-100 Pneumatic Tube Systems, From lkerd.com</p>
200	Generic elements; schematic layout with approximate size, shape, and location of equipment and tubing;	 <p>98 D1050.70-LOD-200 Pneumatic Tube Systems, From lkerd.com</p>

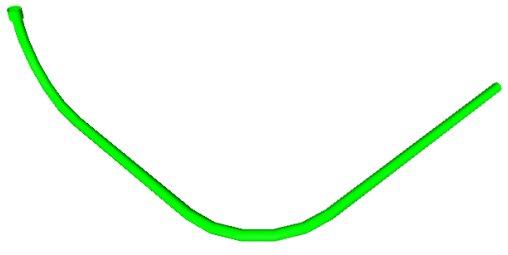
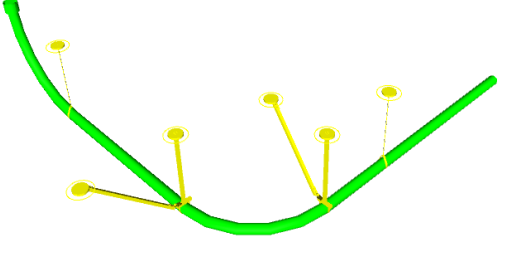

Unifomat Omniclass

<p>300</p>	<p>Modeled as design-specified elements; specified size, shape, spacing, and location of equipment and tubing; approximate allowances for spacing and clearances required for all specified hangers, supports, vibration and seismic control that are to be utilized in the layout of all equipment and tubing are modeled or accommodated by model checking software; access/code clearance requirements modeled or accommodated by model checking software.</p>	 <p>99 D1050.70-LOD-300 Pneumatic Tube Systems, From lkerd.com</p>
<p>350</p>	<p>Modeled as <i>actual construction</i> elements; actual size, shape, spacing, and location/connections of equipment and tubing; actual size, shape, spacing, and clearances required for all hangers, supports, vibration and seismic control that are utilized in the layout of all equipment and tubing are or accommodated by model checking software; floor and wall penetrations modeled. actual access/code clearance requirements modeled or accommodated by model checking software.</p>	 <p>100 D1050.70-LOD-350 Pneumatic Tube Systems, From lkerd.com</p>



Unifomat Omniclass

400	Supplementary components added to the model required for fabrication and field installation	 <p>101 D1050.70-LOD-400 Pneumatic Tube Systems, From lkerd.com</p>
-----	---	---

D1080 21-04 10 80 Operable Access Systems

Associated Masterformat Sections:

[See [Fundamental LOD Definitions](#)]

D1080.10 21-04 10 80 10 Suspended Scaffolding

Includes: Suspended scaffolding when part of the completed project.

Associated Masterformat Sections: 14 81 00

[See [Fundamental LOD Definitions](#)]

D1080.20 21-04 10 80 20 Rope Climbers

Includes: Powered rope climbers to access exterior façade.

Associated Masterformat Sections: 14 82 00

[See See [Fundamental LOD Definitions](#)]

D1080.30 21-04 10 80 30 Elevating Platforms

Includes: Fixed elevating platforms to provide a movable elevated working platform for people and materials.



Unifomat Omniclass

Associated Masterformat Sections: 14 83 00

[See See [Fundamental LOD Definitions](#)]

D1080.40 21-04 10 80 40 Powered Scaffolding

Includes: Powered scaffolding when part of the completed project.

Associated Masterformat Sections: 14 84 00 / 14 84 13

[See [Fundamental LOD Definitions](#)]

D1080.50 21-04 10 80 50 Building Envelope Access

Associated Masterformat Sections: 11 24 23

[See [Fundamental LOD Definitions](#)]

D20 21-04 20 Plumbing

Associated Masterformat Sections: 01 86 16 / 22 00 00

100	Diagrammatic or schematic model elements; conceptual and/or schematic layout/flow diagram; design performance parameters as defined in the BXP to be associated with model elements as non-graphic information.	
-----	---	--

D2010 21-04 20 10 Domestic Water Distribution

Includes: Facility domestic water distribution system. Include Domestic Water Distribution Supplementary Components as appropriate.

Associated Masterformat Sections: 01 86 16 / 22 11 00

100	See D20	
200	Schematic layout of generic model elements with approximate size, shape, and location of elements; shaft requirements modeled;	

D2010.10 21-04 20 10 10 Facility Potable-Water Storage Tanks

Includes: Tanks for storage of potable water serving a facility and located within, on, under, or closely associated with a structure.

Associated Masterformat Sections: 22 12 00

100	See D20	
-----	-------------------------	--

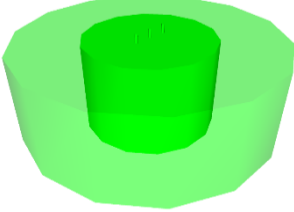
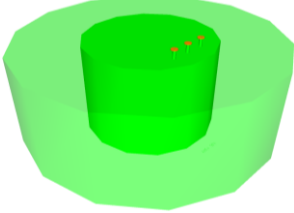
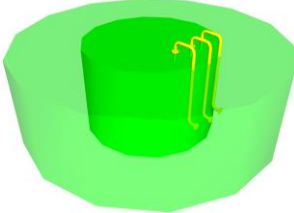
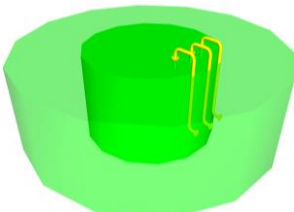

Unifomat Omniclass

<p>200</p>	<p>Schematic layout with approximate size, shape, and location of tank(s);</p>	 <p>102 D2010.10-LOD-200 Facility Potable-Water Storage Tanks, From lkerd.com</p>
<p>300</p>	<p>Modeled as design-specified size, shape, spacing, and location of tank(s); access/code clearance requirements and approximate allowances for spacing and clearances required for all specified anchors, supports, vibration and seismic control that are utilized in the layout of tanks(s) are modeled or accommodated by model checking software;</p>	 <p>103 D2010.10-LOD-300 Facility Potable-Water Storage Tanks, From lkerd.com</p>
<p>350</p>	<p>Modeled as actual construction elements <i>size and shape, spacing, and location/connections</i> of tank(s) actual access/code clearance requirements and actual size and shape, spacing, and clearances required for all specified anchors, supports, vibration and seismic control that are modeled or accommodated by model checking software.</p>	 <p>104 D2010.10-LOD-350 Facility Potable-Water Storage Tanks, From lkerd.com</p>
<p>400</p>	<p>Supplementary components added to the model required for fabrication and field installation.</p>	 <p>105 D2010.10-LOD-400 Facility Potable-Water Storage Tanks, From lkerd.com</p>





Unifomat Omniclass

D2010.20 21-04 20 10 20 Domestic Water Equipment

Includes: Equipment for domestic water distribution system. Includes: Equipment for the softening of domestic water. Includes: Equipment for the filtering of domestic water. Includes: Equipment to heat domestic water. Includes electric and fuel-fired equipment. Includes: Equipment to heat domestic water by means of heat exchange.

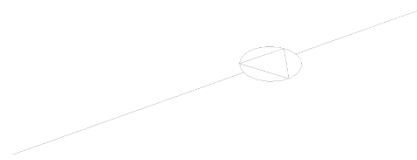
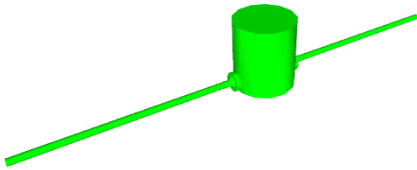
Associated Masterformat Sections: 22 11 23 / 22 31 00 / 22 32 00 / 22 33 00 / 22 34 00
22 35 00

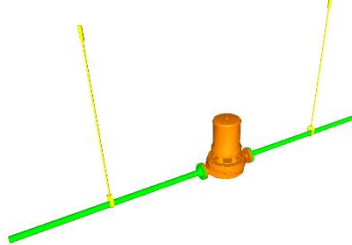
100	See D20	 <p>106 D2010.20-LOD-100 Domestic Water Equipment, From lkerd.com</p>
200	Schematic layout with approximate size, shape, and location of equipment; approximate access/code clearance requirements modeled;	 <p>107 D2010.20-LOD-200 Domestic Water Equipment, From lkerd.com</p>
300	Modeled as design-specified size, shape, spacing, and location of equipment; approximate allowances for spacing and clearances required for all specified anchors, supports, vibration and seismic control that are utilized in the layout of equipment; access/code clearance requirements modeled.	 <p>108 D2010.20-LOD-300 Domestic Water Equipment, From lkerd.com</p>
350	Modeled as actual construction elements size, shape, spacing, and location/connections of equipment; Actual size, shape, spacing, and clearances required for all specified anchors, supports, vibration and seismic control that are utilized in the layout of equipment. actual access/code clearance requirements modeled.	 <p>109 D2010.20-LOD-350 Domestic Water Equipment, From lkerd.com</p>

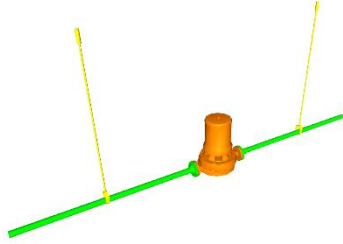

Unifomat Omniclass

400	See D2010.10	 <p>110 D2010.20-LOD-400 Domestic Water Equipment, From lkerd.com</p>
-----	------------------------------	--

D2010.40 21-04 20 10 40 Domestic Water Piping

Includes: Piping, valves, and specialties associated with domestic water distribution located within, under, or closely associated with a structure. Includes circulating pumps. May Include: Water service from the structure to the utility water service line.

Associated Masterformat Sections: 22 11 16 / 22 11 19

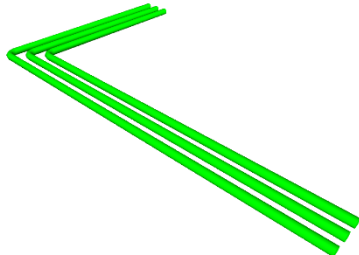
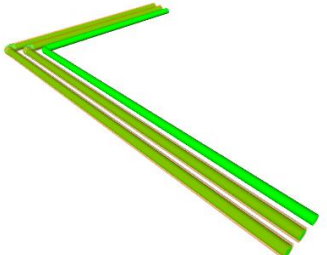
100	Diagrammatic or schematic model elements; conceptual and/or schematic flow diagrams; design performance parameters as defined in the BXP to be associated with model elements as non-graphic information.	
200	Schematic layout with approximate size, shape, and location of mains and risers; shaft requirements modeled;	 <p>111 D2010.40-LOD-200 Domestic Water Piping, From lkerd.com</p>
300	Modeled as design-specified size, shape, spacing, and location of pipe, valves, fittings, and insulation for risers, mains, and branches; approximate allowances for spacing and clearances required for all specified hangers, supports, vibration and seismic control that are to be utilized in the layout of all risers, mains, and branches; access/code clearance requirements modeled.	 <p>112 D2010.40-LOD-300 Domestic Water Piping, From lkerd.com</p>

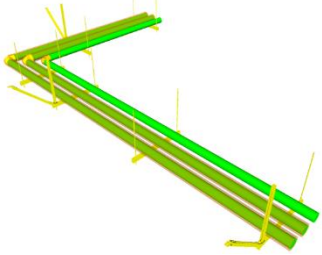
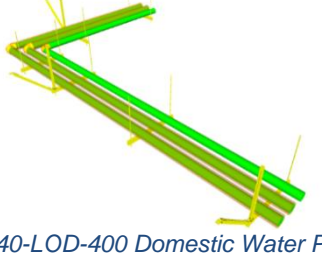

Unifomat Omniclass

<p>350</p>	<p>Modeled as actual construction elements;</p> <p>Actual size, shape, spacing, and location/connections of pipe, valves, fittings, and insulation for risers, mains, and branches;</p> <p>Actual size, shape, spacing, and clearances required for all hangers, supports, vibration and seismic control that are utilized in the layout of all risers, mains, and branches;</p> <p>Actual floor and wall penetration elements modeled.</p> <p>actual access/code clearance requirements modeled.</p>	 <p>113D2010.40-LOD-350 Domestic Water Piping, From lkerd.com</p>
<p>400</p>	<p>See D2010.10</p>	 <p>114D2010.40-LOD-400 Domestic Water Piping, From lkerd.com</p>

D2010.60 21-04 20 10 60 Plumbing Fixtures

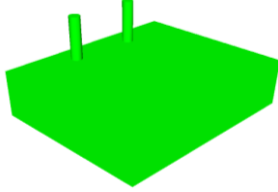

Includes: Terminal devices on the domestic water plumbing system. Includes rough-in piping, trim, fittings, and connection to vent piping.

Associated Masterformat Sections: 22 40 00 / 22 41 00 / 22 41 13 / 22 41 16 / 22 41 19 / 22 41 23 / 22 41 26 / 22 41 36 / 22 41 39 / 22 42 00 / 22 42 13 / 22 42 16 / 22 42 19 / 22 42 23 / 22 42 26 / 22 42 29 / 22 42 33 / 22 42 36 / 22 42 39 / 22 42 43 / 22 43 00 / 22 43 13 / 22 43 16 / 22 43 19 / 22 43 23 / 22 43 39 / 22 43 43 / 22 45 00 / 22 45 13 / 22 45 16 / 22 45 26 / 22 45 29 / 22 45 33 / 22 45 36 / 22 46 00 / 22 46 13 / 22 46 16 / 22 46 39 / 22 46 43 / 22 46 53 / 22 47 00 / 22 47 13 / 22 47 23

<p>100</p>	<p>See D20</p>	
<p>200</p>	<p>Schematic layout with approximate size, shape, and location of fixtures;</p> <p>carrier and wall width requirements modeled;</p>	 <p>115D2010.60-LOD-200 Plumbing Fixtures, From lkerd.com</p>

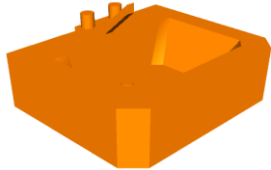

Uniformat Omniclass

<p>300</p>	<p>Modeled as design-specified size, shape, spacing, and location of fixtures;</p> <p>Approximate allowances for spacing and clearances required for all specified supports that are to be utilized in the layout of all fixtures;</p> <p>access/code clearance requirements modeled.</p>	 <p>116 D2010.60-LOD-200 Plumbing Fixtures, From lkerd.com</p>
<p>350</p>	<p>Modeled as actual construction elements size, shape, spacing, and location/connections of fixtures/carriers;</p> <p>Actual size, shape, spacing, and clearances required for all supports that are utilized in the layout of all fixtures.</p> <p>Actual access/code clearance requirements modeled.</p>	 <p>117 D2010.60-LOD-350 Plumbing Fixtures, From lkerd.com</p>
<p>400</p>	<p>See D2010.10</p>	 <p>118 D2010.60-LOD-400 Plumbing Fixtures, From lkerd.com</p>

D2010.90 21-04 20 10 90 Domestic Water Distribution Supplementary Components

Includes: Common work results for plumbing, plumbing insulation, and instrumentation. Includes: expansion fittings, meters, gages, valves, hangers, supports, heat tracing, vibration and seismic controls.

These components are typically modeled as part of other assemblies listed in the tables above. Do not assign this Uniformat classification unless a supplementary component is modeled independently of another assembly.

Associated Masterformat Sections: 05 45 13 / 22 05 00 / 22 05 16 / 22 05 19 / 22 05 23
22 05 29 / 22 05 33 / 22 05 48 / 22 05 53 / 22 07 00 / 22 09 00

D2020 21-04 20 20 Sanitary Drainage

Includes: Facility sanitary sewerage system located within, under, or closely associated with a structure. Include Sanitary Drainage Supplementary Components as appropriate.

Associated Masterformat Sections: 01 86 16 / 22 13 00





Unifomat Omniclass

100	See D20	
200	See D2010	

D2020.10 21-04 20 20 10 Sanitary Sewerage Equipment

Includes: Interceptor, separator, pumps, and septic tanks that are part of facility sanitary sewerage system.

Associated Masterformat Sections: 22 13 23 / 22 13 26 / 22 13 29 / 22 13 33 / 22 13 36
22 13 43 / 22 13 53

100	See D20	
200	Schematic layout with approximate size, shape, and location of equipment;	 <p>119 D2020.10-LOD-200 Sanitary Sewerage Equipment, From lkerd.com</p>
300	Modeled as design specified size, shape, spacing, and location of equipment; Approximate allowances for spacing and clearances required for all specified anchors, supports, vibration and seismic control that are utilized in the layout of equipment are modeled. access/code clearance requirements modeled.	 <p>120.D2020.10-LOD-300 Sanitary Sewerage Equipment, From lkerd.com</p>
350	Actual size, shape, spacing, and clearances required for all specified anchors, supports, vibration and seismic control that are utilized in the layout of equipment; actual access/code clearance requirements modeled.	 <p>121 D2020.10-LOD-350 Sanitary Sewerage Equipment, From lkerd.com</p>



Unifomat Omniclass

400	Supplementary components added to the model required for fabrication and field installation	 <p>122 D2020.10-LOD-400 Sanitary Sewerage Equipment, From lkerd.com</p>
-----	---	--

D2020.30 21-04 20 20 30 Sanitary Sewerage Piping

Includes: Sanitary waste and vent piping system within and under structures. May Include: Sanitary piping from the structure to the utility sanitary sewer.

Associated Masterformat Sections: 22 13 13 / 22 13 16 / 22 13 19 / 22 05 73 / 22 05 76

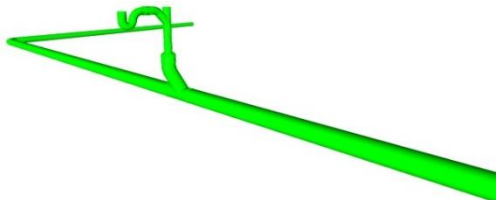
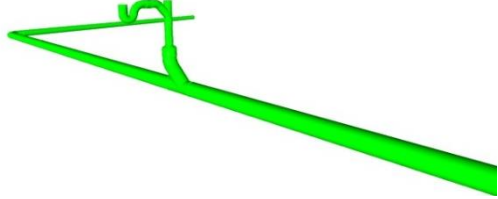
100	See D20	
200	Schematic layout with approximate size, shape, and location of mains and risers; shaft requirements modeled;	 <p>123 D2020.30-LOD-200 Sanitary Sewerage Piping, From lkerd.com</p>
300	Modeled as design-specified size, shape, spacing, location, and slope of pipe, valves, fittings, and insulation for risers, mains, and branches; Approximate allowances for spacing and clearances required for all specified hangers, supports, vibration and seismic control that are to be utilized in the layout of all risers, mains, and branches; access/code clearance requirements modeled	 <p>124 D2020.30-LOD-300 Sanitary Sewerage Piping, From lkerd.com</p>

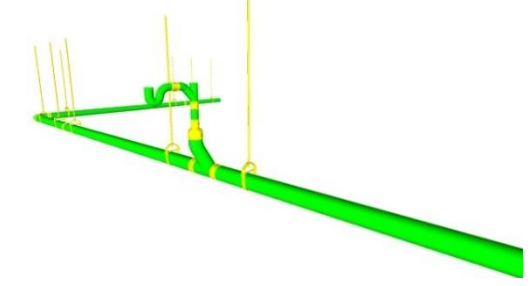
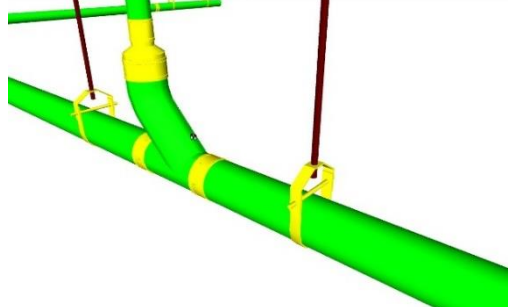

Unifomat Omniclass

<p>350</p>	<p>Modeled as actual construction elements;</p> <p>Actual size, shape, spacing, location, connections, and slope of pipe, valves, fittings, and insulation for risers, mains, and branches;</p> <p>Actual size, shape, spacing, and clearances required for all hangers, supports, vibration and seismic control that are utilized in the layout of all risers, mains, and branches;</p> <p>Actual floor and wall penetration elements modeled.</p> <p>Actual access/code clearance requirements modeled</p>	 <p>125 D2020.30-LOD-350 Sanitary Sewerage Piping, From lkerd.com</p>
<p>400</p>	<p>See D2020.10</p>	 <p>126 D2020.30-LOD-400 Sanitary Sewerage Piping, From lkerd.com</p>

D2020.90 21-04 20 20 90 Sanitary Drainage Supplementary Components

Includes: Common work results for plumbing, plumbing insulation, and instrumentation and control for plumbing to be included with sanitary drainage elements above as appropriate. Includes expansion fittings, meters, gages, valves, hangers, supports, heat tracing, vibration and seismic controls.

These components are typically modeled as part of other assemblies listed in the tables above. Do not assign this Unifomat classification unless a supplementary component is modeled independently of another assembly.

Associated Masterformat Sections: 05 45 13 / 22 05 00 / 22 05 16 / 22 05 19 / 22 05 23
22 05 29 / 22 05 33 / 22 05 48 / 22 05 53 / 22 07 00 / 22 09 00

D2030 21-04 20 30 Building Support Plumbing Systems

Includes: Facility storm water drainage and gray water systems. Include Building Support Plumbing System Supplementary Components as appropriate.

Associated Masterformat Sections: 01 86 16 / 22 14 00

<p>100</p>	<p>See D20</p>	
<p>200</p>	<p>See D2010</p>	







Unifomat Omniclass

D2030.10 21-04 20 30 10 Stormwater Drainage Equipment

Includes: Drainage pumps, and sump pumps that are part of stormwater drainage system.

Associated Masterformat Sections: 22 14 29 / 22 14 33 / 22 14 36 / 22 14 53

100	Diagrammatic or schematic model elements; conceptual and/or schematic layout;	
200	Schematic layout with approximate size, shape, and location of equipment; approximate access/code clearance requirements modeled;	 <p>127 D2030.10-LOD-200 Stormwater Drainage Equipment, From lkerd.com</p>
300	Modeled as design-specified size, shape, spacing, and location of equipment; approximate allowances for spacing and clearances required for all specified anchors, supports, vibration and seismic control that are utilized in the layout of equipment; access/code clearance requirements modeled.	 <p>128 D2030.10-LOD-300 Stormwater Drainage Equipment, From lkerd.com</p>
350	Modeled as actual construction elements size, shape, spacing, and location/connections of equipment, actual size, shape, spacing, and clearances required for all specified anchors, supports, vibration and seismic control that are utilized in the layout of equipment; actual access/code clearance requirements modeled.	 <p>129 D2030.10-LOD-350 Stormwater Drainage Equipment, From lkerd.com</p>
400	Supplementary components added to the model required for fabrication and field installation.	 <p>130 D2030.10-LOD-400 Stormwater Drainage Equipment, From lkerd.com</p>



Unifomat Omniclass

D2030.20 21-04 20 30 20 Stormwater Drainage Piping

Includes: Storm drainage piping system within, under, or closely associated with a structure. Includes storm drains for areas closely associated with a structure such as courtyards, plazas, and loading dock areas. May Include: Storm drainage piping from the structure to the utility storm drain.

Associated Masterformat Sections: 22 05 73 / 22 05 76 / 22 14 13 / 22 14 16 / 22 14 23

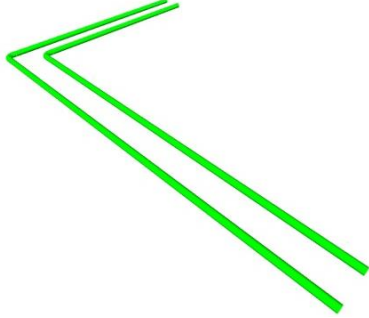
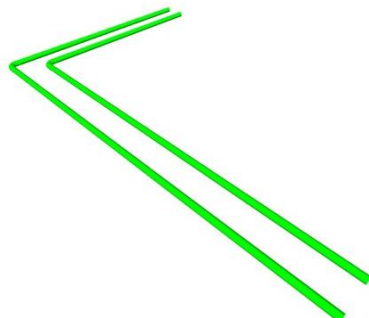
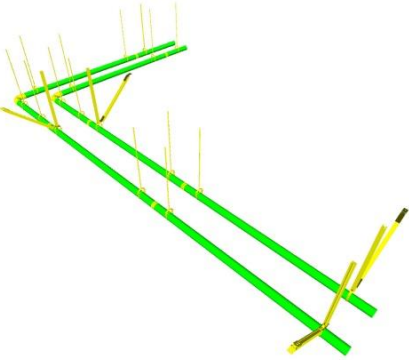
100	See D20	
200	Schematic layout with approximate size, shape, and location of mains and risers; shaft requirements modeled;	 <p>131 D2030.20-LOD-200 Stormwater Drainage Piping, From lkerd.com</p>
300	Modeled as design-specified size, shape, spacing, location, and slope of pipe, valves, fittings, and insulation for risers, mains, and branches; approximate allowances for spacing and clearances required for all specified hangers, supports, vibration and seismic control that are to be utilized in the layout of all risers, mains, and branches; access/code clearance requirements modeled.	 <p>132 D2030.20-LOD-300 Stormwater Drainage Piping, From lkerd.com</p>
350	Modeled as actual size, shape, spacing, location, connections, and slope of pipe, valves, fittings, and insulation for risers, mains, and branches; actual size and shape, spacing, and clearances required for all hangers, supports, vibration and seismic control that are utilized in the layout of all risers, mains, and branches; Actual access/code clearance requirements modeled. actual floor and wall penetration elements modeled.	 <p>133 D2030.20-LOD-350 Stormwater Drainage Piping, From lkerd.com</p>

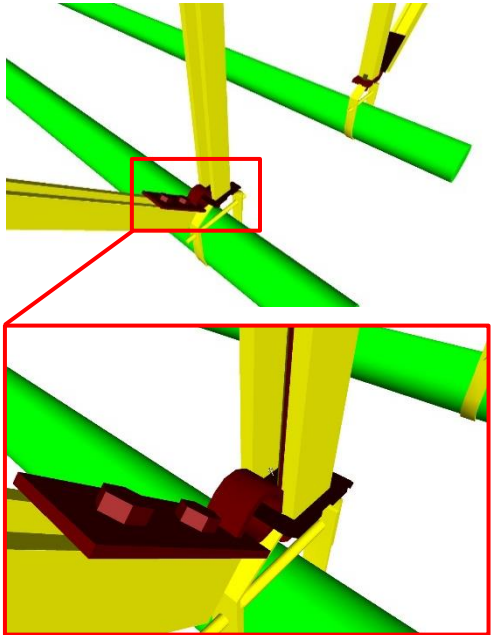

Unifomat Omniclass

<p>400</p>	<p>See D2030.10</p>	 <p>134 D2030.20-LOD-400 Stormwater Drainage Piping, From lkerd.com</p>
------------	-------------------------------------	---

D2030.30 21-04 20 30 30 Facility Stormwater Drains

Includes: Various types of drains to collect storm water.

Associated Masterformat Sections: 22 14 26

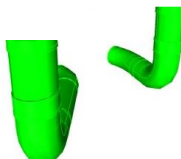
<p>100</p>	<p>See D20</p>	
<p>200</p>	<p>Schematic layout with approximate size, shape, and location of components;</p>	 <p>135 D2030.30-LOD-200 Facility Stormwater Drains, From lkerd.com</p>

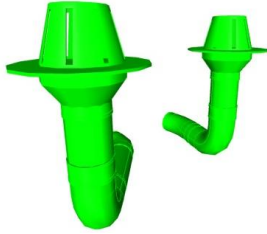
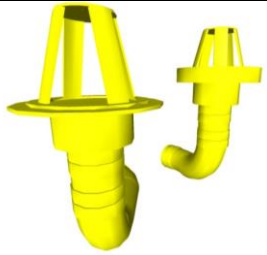
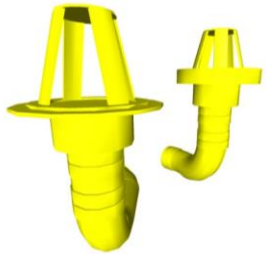

Unifomat Omniclass

<p>300</p>	<p>Modeled as design-specified size, shape, spacing, and location of components;</p> <p>approximate allowances for spacing and clearances required for all specified hangers, supports, vibration and seismic control that are to be utilized in the layout of all components;</p> <p>access/code clearance requirements modeled.</p>	 <p>136 D2030.30-LOD-300 Facility Stormwater Drains, From lkerd.com</p>
<p>350</p>	<p>Modeled as actual construction elements size, shape, spacing, and location/connections of components;</p> <p>actual size, shape, spacing, and clearances required for all hangers, supports, vibration and seismic control that are utilized in the layout of all components.</p> <p>Actual access/code clearance requirements modeled.</p>	 <p>137 D2030.30-LOD-350 Facility Stormwater Drains, From lkerd.com</p>
<p>400</p>	<p>See D2030.10</p>	 <p>138 D2030.30-LOD-400 Facility Stormwater Drains, From lkerd.com</p>

D2030.60 21-04 20 30 60 **Gray Water Systems**
Includes: Systems to collect, treat, and distribute gray water for other uses such as irrigation.

Associated Masterformat Sections: 22 13 63

[See [D2030.20](#)]



Uniformat Omniclass

D2030.90 21-04 20 30 90 Building Support Plumbing System Supplementary Components

Includes: Common work results for plumbing, plumbing insulation, and instrumentation and control for plumbing to be included with building support plumbing system elements above as appropriate. Includes expansion fittings, meters, gages, valves, hangers, supports, heat tracing, vibration and seismic controls.

These components are typically modeled as part of other assemblies listed in the tables above. Do not assign this Uniformat classification unless a supplementary component is modeled independently of another assembly.

Associated Masterformat Sections: 05 45 13 / 22 05 00 / 22 05 16 / 22 05 19 / 22 05 23
22 05 29 / 22 05 33 / 22 05 48 / 22 05 53 / 22 07 00 / 22 09 00

D2050 21-04 20 50 General Service Compressed-Air

Includes: Compressed air system serving general service requirements

Associated Masterformat Sections: 01 86 16 / 22 15 00 / 22 15 13 / 22 15 16 / 22 15 19

[See [D2060.10](#) – Compressed-Air Systems]

D2060 21-04 20 60 Process Support Plumbing Systems

Includes: Process Support Plumbing System Supplementary Components as appropriate.

Associated Masterformat Sections:

100	See D20	
200	Schematic layout with approximate size, shape, and location of mains and risers; shaft requirements modeled;	

D2060.10 21-04 20 60 10 Compressed-Air Systems

Associated Masterformat Sections: 01 86 16 / 22 61 00 / 22 61 13 / 22 61 19

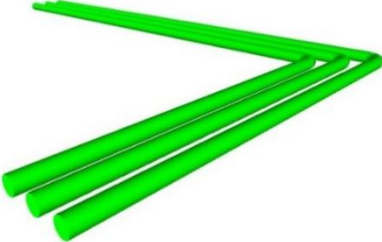
100	See D20	
200	See D2060	 <p>139D2060.10-LOD-200 Compressed-Air Systems, From lkerd.com</p>

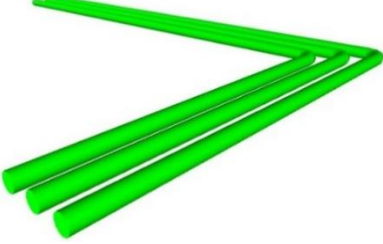
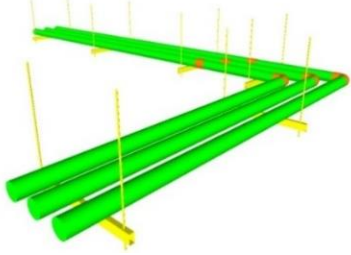
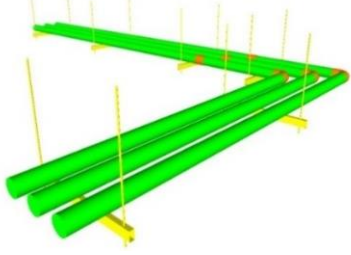

Unifomat Omniclass

<p>300</p>	<p>Modeled as design-specified size, shape, spacing, location, and slope of equipment/pipe, valves, fittings, and insulation for risers, mains, and branches;</p> <p>approximate allowances for spacing and clearances required for all specified hangers, supports, vibration and seismic control that are to be utilized in the layout of all risers, mains, and branches;</p> <p>access/code clearance requirements modeled.</p>	 <p>140 D2060.10-LOD-300 Compressed-Air Systems, From lkerd.com</p>
<p>350</p>	<p>Modeled as actual size, shape, spacing, location, connections, and slope of equipment/pipe, valves, fittings, and insulation for risers, mains, and branches;</p> <p>actual size, shape, spacing, and clearances required for all hangers, supports, vibration and seismic control that are utilized in the layout of all risers, mains, and branches;</p> <p>actual access/code clearance requirements modeled.</p> <p>actual floor and wall penetration elements modeled.</p>	 <p>141 D2060.10-LOD-350 Compressed-Air Systems, From lkerd.com</p>
<p>400</p>	<p>Supplementary components added to the model required for fabrication and field installation.</p>	 <p>142 D2060.10-LOD-400 Compressed-Air Systems, From lkerd.com</p>

D2060.20 21-04 20 60 20 Vacuum Systems

Includes: Vacuum systems for laboratory and healthcare purposes.

Associated Masterformat Sections: 01 86 16 / 22 62 00 / 22 62 13 / 22 62 19 / 22 62 23

[See [D2060.10](#)]

D2060.30 21-04 20 60 30 Gas Systems

Includes: Gas systems for laboratory and healthcare purposes.

Associated Masterformat Sections: 01 86 16 / 22 63 00 / 22 63 13 / 22 63 19

[See [D2060.10](#)]



Uniformat Omniclass

D2060.40 21-04 20 60 40 Chemical-Waste Systems

Includes: Chemical-waste systems for laboratory and healthcare purposes.

Associated Masterformat Sections: 01 86 16 / 22 66 00 / 22 66 53 / 22 66 70 / 22 66 83

[See [D2060.10](#)]

D2060.50 21-04 20 60 50 Processed Water Systems

Includes: Processed water systems for laboratory and healthcare purposes.

Associated Masterformat Sections: 01 86 16 / 22 67 00 / 22 67 13 / 22 67 19

[See [D2060.10](#)]

D2060.90 21-04 20 60 90 Process Support Plumbing System Supplementary Components

Includes expansion fittings, meters, gages, valves, hangers, supports, heat tracing, vibration and seismic controls. Includes: Common work results for plumbing, plumbing insulation, and instrumentation and controls to be included with process support plumbing systems elements above as appropriate.

These components are typically modeled as part of other assemblies listed in the tables above. Do not assign this Uniformat classification unless a supplementary component is modeled independently of another assembly.

Associated Masterformat Sections: 05 45 13 / 05 45 23 / 22 05 00 / 22 05 23 / 22 05 29 / 22 05 33 / 22 05 48 / 22 05 53 / 22 07 00 / 22 09 00

D30 21-04 30 Heating, Ventilation, and Air Conditioning (HVAC)

Associated Masterformat Sections: 01 86 19 / 23 00 00

100	Diagrammatic or schematic model elements; conceptual and/or schematic layout/flow diagram;	
-----	---	--

D3010 21-04 30 10 Facility Fuel Systems

Includes: Fuel-oil, gasoline, natural-gas, and liquefied-petroleum fuel systems associated with a structure.

Associated Masterformat Sections: 01 86 19 / 23 10 00

100	See D30	
200	Schematic layout with approximate size, shape, and location of element(s); approximate access/code clearance requirements modeled; shaft requirements modeled;	



Unifomat Omniclass

D3010.10 21-04 30 10 10 Fuel Piping

Includes: Fuel piping, valves, piping specialties, and other components within, under, or closely associated with a structure.

Associated Masterformat Sections: 23 11 00

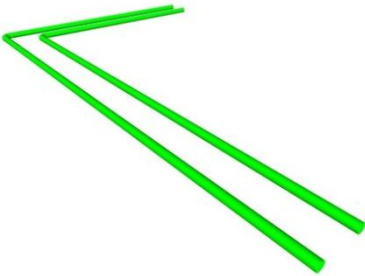
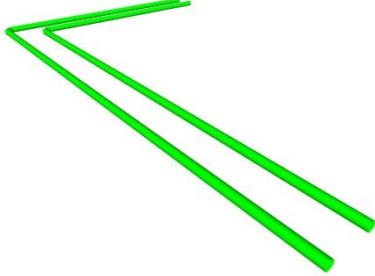
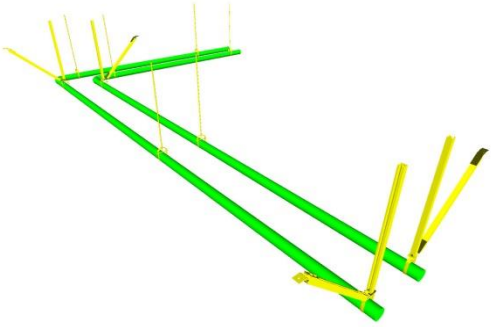
100	See D30	
200	See D3010	 <p>143 D3010.10-200 Fuel Piping, From lkerd.com</p>
300	<p>Modeled as design-specified size, shape, spacing, and location of pipe, valves, fittings, and insulation for risers, mains, and branches;</p> <p>approximate allowances for spacing and clearances required for all specified hangers, supports, vibration and seismic control that are to be utilized in the layout of all risers, mains, and branches;</p> <p>access/code clearance requirements modeled.</p>	 <p>144 D3010.10-300 Fuel Piping, From lkerd.com</p>
350	<p>Modeled as actual size, shape, spacing, and location/connections of pipe, valves, fittings, and insulation for risers, mains, and branches;</p> <p>actual size, shape, spacing, and clearances required for all hangers, supports, vibration and seismic control that are utilized in the layout of all risers, mains, and branches;</p> <p>actual access/code clearance requirements modeled.</p> <p>actual floor and wall penetration elements modeled.</p>	 <p>145 D3010.10-350 Fuel Piping, From lkerd.com</p>
400	Supplementary components added to the model required for fabrication and field installation	



Unifomat Omniclass

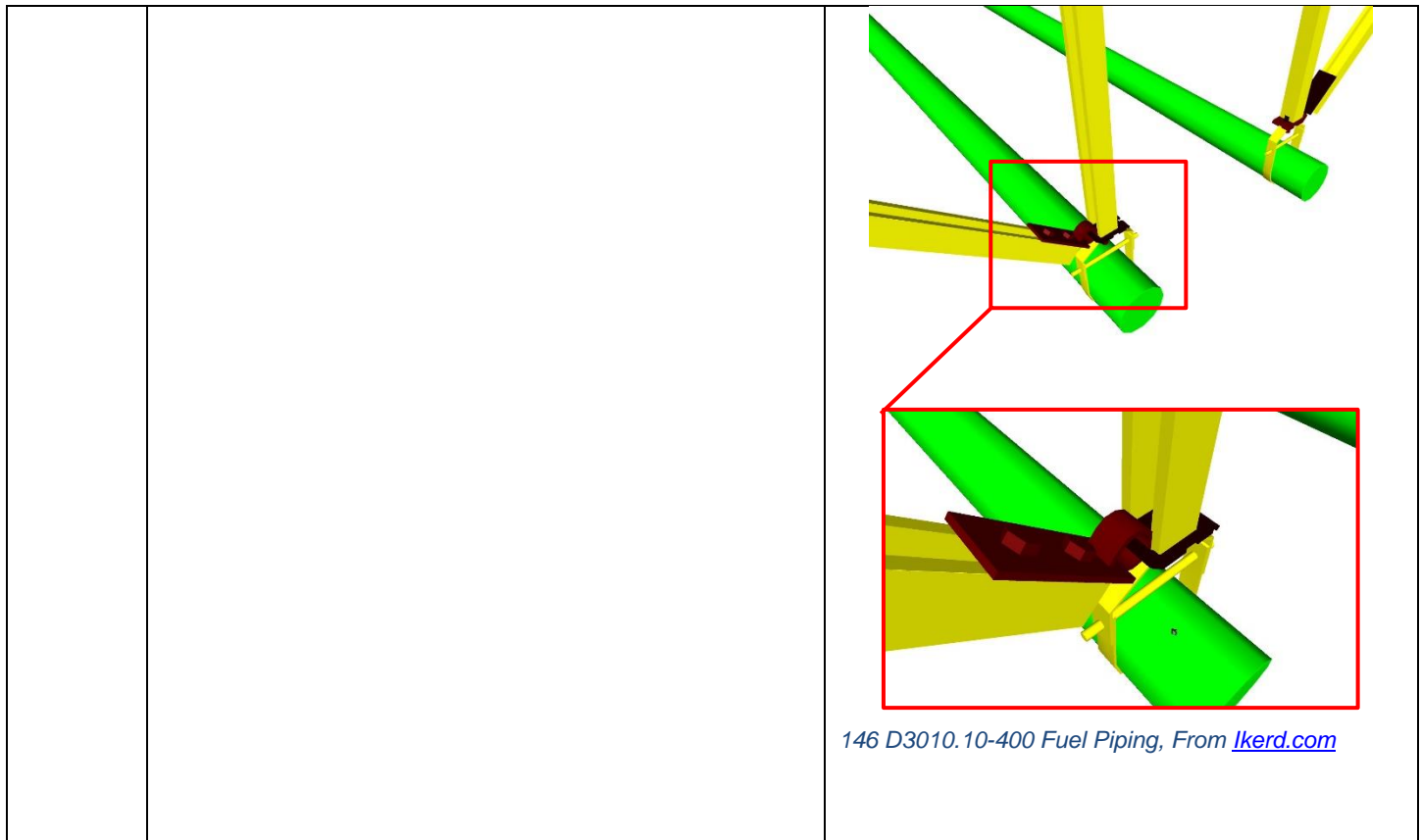

D3010.30 21-04 30 10 30 Fuel Pumps

Includes: Fuel pumps within or closely associated with a structure.

Associated Masterformat Sections: 23 12 00 / 23 12 13 / 23 12 16

100	See D30	
200	See D3010	
300	Modeled as design-specified size, shape, spacing, and location of equipment; approximate allowances for spacing and clearances required for all specified anchors, supports, vibration and seismic control that are utilized in the layout of equipment; access/code clearance requirements modeled.	
350	Modeled as actual size, shape, spacing, and location/connections of equipment; actual size, shape, spacing, and clearances required for all specified anchors, supports, vibration and seismic control that are utilized in the layout of equipment.	



Unifomat Omniclass

	actual access/code clearance requirements modeled.	
400	See D3010.10	

D3010.50 21-04 30 10 50 Fuel Storage Tanks

Includes: Fuel tanks under or closely associated with a structure.

Associated Masterformat Sections: 23 13 00

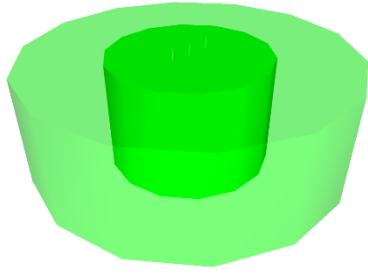
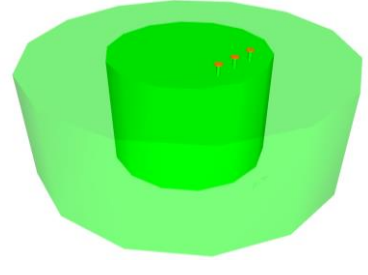
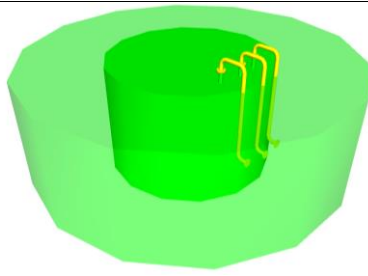
100	See D30	
200	See D3010	 <p><i>147 D3010.50-LOD-200 Fuel Storage Tanks, From lkerd.com</i></p>
300	Modeled as design-specified size, shape, spacing, and location of tank(s); approximate allowances for spacing and clearances required for all specified anchors, supports, vibration and seismic control that are utilized in the layout of tanks(s); access/code clearance requirements modeled.	 <p><i>148 D3010.50-LOD-300 Fuel Storage Tanks, From lkerd.com</i></p>
350	Modeled as actual size, shape, spacing, and location/connections of tank(s); actual size, shape, spacing, and clearances required for all specified anchors, supports, vibration and seismic control that are utilized in the layout of tanks(s). actual access/code clearance requirements modeled.	 <p><i>149 D3010.50-LOD-350 Fuel Storage Tanks, From lkerd.com</i></p>

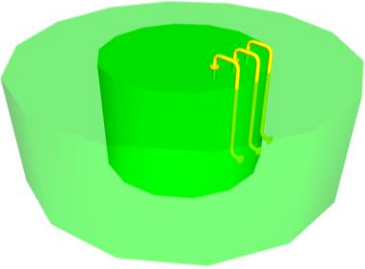

Unifomat Omniclass

400	See D3010.10	 <p data-bbox="959 583 1503 642">150 D3010.50-LOD-400 Fuel Storage Tanks, From lkerd.com</p>
-----	------------------------------	---

D3020 21-04 30 20 Heating Systems

Includes: Associated ductwork, piping, valves, and specialties. Includes: Heating System Supplementary Components as appropriate.

Associated Masterformat Sections: 01 86 19

100	See D30	
200	Schematic layout with approximate size, shape, and location of element(s); shaft requirements modeled;	

D3020.10 21-04 30 20 10 Heat Generation

Includes: Boilers, furnaces, solar, geothermal, and biomass heat generation, fuel fired heaters, and heat exchangers. Includes: Fuel-fired boilers and generators for hot water and steam systems. Includes breechings, chimneys, and stacks. Includes: Electric boilers and generators for hot water and steam systems. Includes: Equipment to remove oxygen and other dissolved gases in boiler feed. Includes: Fuel-fired and electric furnaces. Includes: Equipment powered by solar energy. Includes: Fuel-fired radiant and unit heaters. Includes: Equipment used to transfer heat from one medium to another.

Associated Masterformat Sections: 23 51 00 / 23 52 00 / 23 52 13 / 23 53 00 / 23 53 13 / 23 53 16 / 23 54 00 / 23 56 00 / 23 56 13 / 23 56 16 / 23 55 00 / 23 57 00

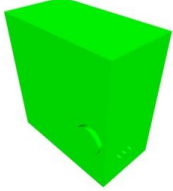
100	See D30	
200	See D3020	 <p data-bbox="967 1703 1479 1761">151 D3020.10-LOD-200 Heat Generation, From lkerd.com</p>

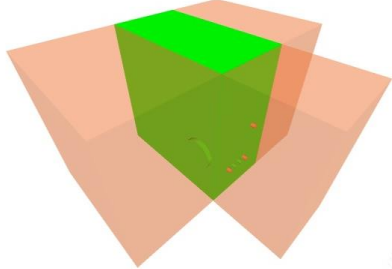
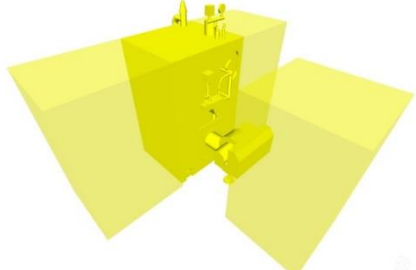
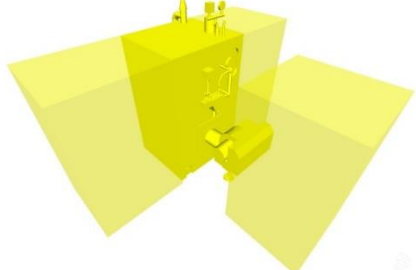

Unifomat Omniclass

<p>300</p>	<p>Modeled as design-specified size, shape, spacing, and location of equipment;</p> <p>approximate allowances for spacing and clearances required for all specified anchors, supports, vibration and seismic control that are utilized in the layout of equipment;</p> <p>access/code clearance requirements modeled.</p>	 <p>152 D3020.10-LOD-300 Heat Generation, From lkerd.com</p>
<p>350</p>	<p>Modeled as actual size, shape, spacing, and location/connections of equipment,</p> <p>actual size, shape, spacing, and clearances required for all specified anchors, supports, vibration and seismic control that are utilized in the layout of equipment.</p> <p>actual access/code clearance requirements modeled.</p>	 <p>153 D3020.10-LOD-350 Heat Generation, From lkerd.com</p>
<p>400</p>	<p>Supplementary components added to the model required for fabrication and field installation.</p>	 <p>154 D3020.10-LOD-400 Heat Generation, From lkerd.com</p>

D3020.30 21-04 30 20 30 Thermal Heat Storage

Includes: Equipment to store thermal energy for use in heating and with charging or discharging this energy at a controllable rate.

Associated Masterformat Sections: 23 71 13

[See [D3020.10](#)]

D3020.70 21-04 30 20 70 Decentralized Heating Equipment

Includes: Heating equipment that serves a portion of a HVAC system. Includes: Convection units may provide heating and cooling.

Includes: Electric cables or panels and hydronic piping used for radiant heating for space heating.

Associated Masterformat Sections: 23 80 00 / 23 82 00 / 23 82 13 / 23 82 14 / 23 82 16 / 23 82 19 / 23 82 23 / 23 82 26 / 23 82 29 / 23 82 33 / 23 82 36 / 23 82 39 / 23 83 00

[Back to TOC](#)



[Please Click here to provide feedback.](#)

Copyright © 2020 by BIMForum. All rights reserved

This document is copyrighted under a [Creative Commons Attribution-NonCommercial-NoDerivatives 4.0 International License](#).

Uniformat Omniclass

[See [D3020.10](#)]

D3020.90 21-04 30 20 90 Heating System Supplementary Components

Includes: Common work results for HVAC, insulation, and instrumentation and control to be included in heating system elements above as appropriate.

These components are typically modeled as part of other assemblies listed in the tables above. Do not assign this Uniformat classification unless a supplementary component is modeled independently of another assembly.

Associated Masterformat Sections: 05 45 13 / 23 05 00 / 23 05 19 / 23 05 23 / 23 05 29 / 23 05 48 / 23 05 53 / 23 05 63 / 23 05 66 / 23 05 93 / 23 07 00 / 23 09 00

D3030 21-04 30 30 Cooling Systems

Includes: Associated ductwork, piping, valves, and specialties. Includes: Cooling System Supplementary Components as appropriate.

Associated Masterformat Sections: 01 86 19

100	See D30	
200	Schematic layout with approximate size, shape, and location of element(s); shaft requirements modeled;	

D3030.10 21-04 30 30 10 Central Cooling

Includes: Refrigerant compressors, condensers, packaged compressor and condenser units, water chillers, and cooling towers. Includes: Various type of compressors used in refrigeration process. Includes: Condensing units used to reject heat from the refrigeration process. Includes: Compressor in combination with condensing units used to reject heat from the refrigeration process. Includes: Various types of chillers used for building space cooling. Includes: Factory- and field-fabricated cooling towers and liquid coolers. Includes piping and specialties; chemical water treatment; vibration and seismic controls; and integral controls not a part of the condenser water distribution systems.

Associated Masterformat Sections: 23 60 00 / 23 61 00 / 23 62 00 / 23 63 00 / 23 64 00 / 23 65 00

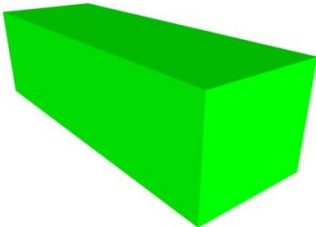
100	See D30	
200	See D3030	 <p><i>155 D3030.10-LOD-200 Central Cooling, From lkerd.com</i></p>

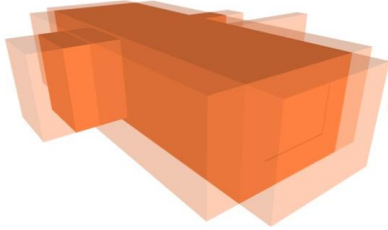
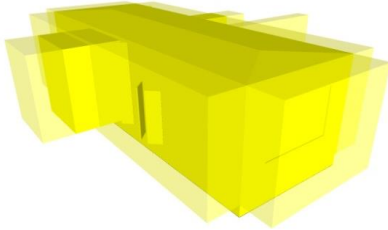
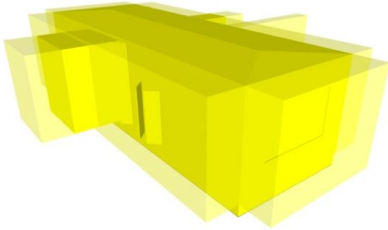

Unifomat Omniclass

<p>300</p>	<p>Modeled as design-specified size, shape, spacing, and location of equipment;</p> <p>approximate allowances for spacing and clearances required for all specified anchors, supports, vibration and seismic control that are utilized in the layout of equipment;</p> <p>access/code clearance requirements modeled.</p>	 <p><i>156 D3030.10-LOD-300 Central Cooling, From lkerd.com</i></p>
<p>350</p>	<p>Modeled as actual size, shape, spacing, and location/connections of equipment;</p> <p>actual size, shape, spacing, and clearances required for all specified anchors, supports, vibration and seismic control that are utilized in the layout of equipment.</p> <p>actual access/code clearance requirements modeled.</p>	 <p><i>157 D3030.10-LOD-350 Central Cooling, From lkerd.com</i></p>
<p>400</p>	<p>Supplementary components added to the model required for fabrication and field installation.</p>	 <p><i>158 D3030.10-LOD-400 Central Cooling, From lkerd.com</i></p>

D3030.30 21-04 30 30 30 Evaporative Air-Cooling

Includes: Equipment used to reject heat from the refrigeration process by evaporation.

Associated Masterformat Sections: 23 76 00

<p>100</p>	<p>See D3030.10</p>	
------------	-------------------------------------	--



Unifomat Omniclass

200	See D3030.10	 <p>159 D3030.30-LOD-200 Evaporative Air-Cooling, From lkerd.com</p>
300	See D3030.10	 <p>160 D3030.30-LOD-300 Evaporative Air-Cooling, From lkerd.com</p>
350	See D3030.10	 <p>161 D3030.30-LOD-350 Evaporative Air-Cooling, From lkerd.com</p>

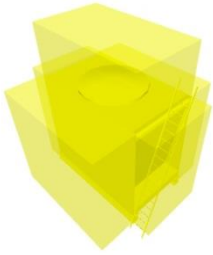

Unifomat Omniclass

400	See D3030.10	 <p style="text-align: center;"><i>162 D3030.30-LOD-400 Evaporative Air-Cooling, From lkerd.com</i></p>
-----	------------------------------	--

D3030.50 21-04 30 30 50 Thermal Cooling Storage

Includes: Equipment to store thermal energy for use in cooling and with charging or discharging this energy at a controllable rate.

Associated Masterformat Sections: 23 71 00 / 23 71 16 / 23 71 19

[See [D3030.10](#)]

D3030.70 21-04 30 30 70 Decentralized Cooling

Includes: Cooling equipment that serves a portion of a HVAC system. Note: Convection units may provide heating and cooling.

Associated Masterformat Sections: 23 80 00 / 23 81 13 / 23 81 16 / 23 81 19 / 23 81 23 /
23 81 26 / 23 81 43 / 23 81 46 / 23 82 00 / 23 82 13 / 23 82 14 / 23 82 16 / 23 82 19 /
23 82 23 / 23 82 26

[See [D3030.10](#)]

D3030.90 21-04 30 30 90 Cooling System Supplementary Components

Includes expansion fittings, meters, gages, valves, hangers, supports, heat tracing, vibration and seismic controls. Includes: Common work results for HVAC, insulation, and instrumentation and control to be included in cooling system elements above as appropriate.

These components are typically modeled as part of other assemblies listed in the tables above. Do not assign this Unifomat classification unless a supplementary component is modeled independently of another assembly.

Associated Masterformat Sections: 05 45 13 / 23 05 00 / 23 05 19 / 23 05 23 / 23 05 29 /
23 05 48 / 23 05 53 / 23 05 63 / 23 05 66 / 23 05 93 / 23 07 00 / 23 09 00

D3050 21-04 30 50 Facility HVAC Distribution Systems

Includes: Facility Distribution Systems Supplementary Components as appropriate.

Associated Masterformat Sections:

100	See D30	
200	Schematic layout with approximate size, shape, and location of element(s);	

D3050.10 21-04 30 50 10 Facility Hydronic Distribution



Unifomat Omniclass

Includes: Piping systems and equipment for distribution of heating hot water and cooling chilled water. Includes piping systems, pumps, tanks, supports and anchors, vibration and seismic controls, identification, and piping and equipment insulation.

Associated Masterformat Sections: 01 86 19 / 23 21 13 / 23 21 23 / 23 25 00

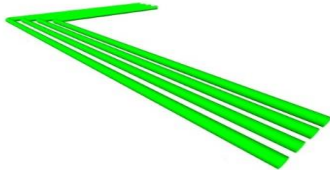
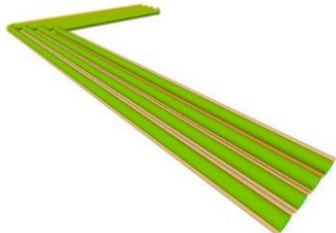
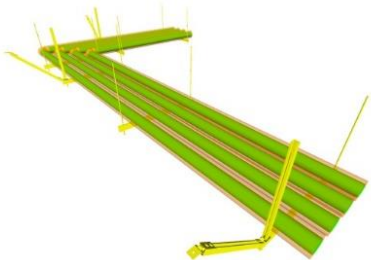
100	See D30	
200	See D3050	 <p data-bbox="971 699 1539 751"><i>163 D3050.10-LOD-200 Facility Hydronic distribution, From lkerd.com</i></p>
300	<p>Modeled as design-specified size, shape, spacing, location, and slope of pipe, valves, fittings, and insulation for risers, mains, and branches;</p> <p>approximate allowances for spacing and clearances required for all specified hangers, supports, vibration and seismic control that are to be utilized in the layout of all risers, mains, and branches;</p> <p>access/code clearance requirements modeled.</p>	 <p data-bbox="971 1108 1539 1161"><i>164 D3050.10-LOD-300 Facility Hydronic Distribution, From lkerd.com</i></p>
350	<p>Modeled as actual size, shape, spacing, location, connections, and slope of pipe, valves, fittings, and insulation for risers, mains, and branches;</p> <p>actual size, shape, spacing, and clearances required for all hangers, supports, vibration and seismic control that are utilized in the layout of all risers, mains, and branches;</p> <p>actual floor and wall penetration elements modeled.</p> <p>actual access/code clearance requirements modeled.</p>	 <p data-bbox="961 1537 1529 1589"><i>165 D3050.10-LOD-350 Facility Hydronic Distribution, From lkerd.com</i></p>

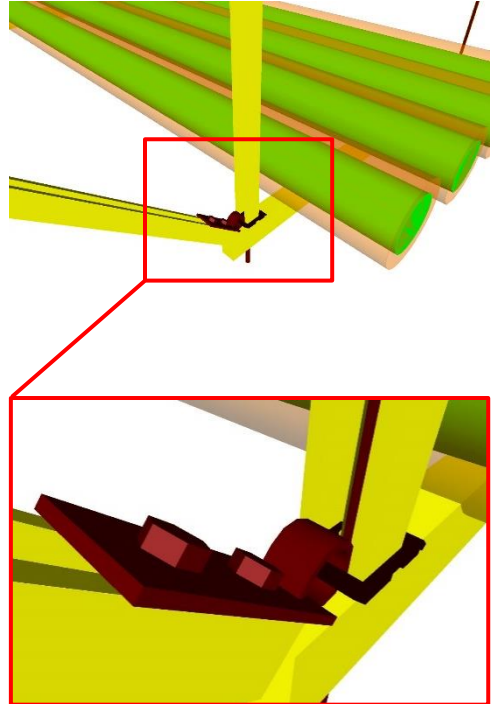

Unifomat Omniclass

<p>400</p>	<p>Supplementary components added to the model required for fabrication and field installation.</p>	 <p>166 D3050.10-LOD-400 Facility Hydronic Distribution, From lkerd.com</p>
------------	---	--

D3050.30 21-04 30 50 30 Facility Steam Distribution

Includes: Piping systems and equipment for distribution of steam and condensate return. Includes piping systems, pumps, tanks, supports and anchors, vibration and seismic controls, identification, and piping and equipment insulation.

Associated Masterformat Sections: 01 86 19 / 23 22 13 / 23 22 23 / 23 25 19

[See [D3050.10](#)]

D3050.50 21-04 30 50 50 HVAC Air Distribution

Includes: Systems for distribution of air including supply systems, return systems, and general exhaust systems. Does not include special exhaust systems such as kitchen hood, paint booth, and fume hood exhaust systems. Includes: Air-handling units consisting of fans, coils, dampers, control devices, and other accessories. Includes: Ducts, duct accessories, fans, terminal units, and air inlets and outlets. Includes: Devices of a variety of types to clean distribution air. Includes: Equipment that adds or removes moisture from a medium in order to control the humidity.

Associated Masterformat Sections: 01 86 19 / 23 73 00 / 23 74 00 / 23 75 00 / 23 30 00 / 23 34 00 / 23 31 00 / 23 32 00 / 23 33 00 / 23 36 00 / 23 37 00 / 23 40 00 / 23 41 00 / 23 42 00 / 23 43 00 / 23 84 00

<p>100</p>	<p>See D30</p>	
------------	--------------------------------	--



Uniformat Omniclass

200	See D3050	
300	Modeled as design-specified size, shape, spacing, and location of duct, dampers, fittings, and insulation for risers, mains, and branches; approximate allowances for spacing and clearances required for all specified hangers, supports, vibration and seismic control that are to be utilized in the layout of all risers, mains, and branches; access/code clearance requirements modeled.	
350	Modeled as actual size, shape, spacing, and location/connections of duct, dampers, fittings, and insulation for risers, mains, and branches; actual size, shape, spacing, and clearances required for all hangers, supports, vibration and seismic control that are utilized in the layout of all risers, mains, and branches; actual floor and wall penetration elements modeled. actual access/code clearance requirements modeled.	
400	See D3050.10	

D3050.90 21-04 30 50 90 **Facility Distribution Systems Supplementary Components**
Includes expansion fittings, meters, gages, valves, hangers, supports, heat tracing, vibration and seismic controls. Includes: Common work results for HVAC, insulation, and instrumentation and control to be included in distribution system elements above as appropriate.

These components are typically modeled as part of other assemblies listed in the tables above. Do not assign this Uniformat classification unless a supplementary component is modeled independently of another assembly.

Associated Masterformat Sections: 05 45 13 / 23 05 00 / 23 05 16 / 23 05 19 / 23 05 23 / 23 05 29 / 23 05 33 / 23 05 48 / 23 05 53 / 23 05 63 / 23 05 66 / 23 05 93 / 23 07 00 / 23 09 00

D3060 21-04 30 60 Ventilation

Includes: Supply air, return air, exhaust air, outside air, and air cleaning systems. Includes Ventilation Supplementary Components as appropriate.

Associated Masterformat Sections: 01 86 19

100	See D30	
200	Schematic layout with approximate size, shape, and location of mains and risers;	

D3060.10 21-04 30 60 10 Supply Air

Associated Masterformat Sections: 23 34 00 / 23 31 00 / 23 32 00 / 23 33 00 / 23 36 00 / 23 37 00

100	See D30	
-----	-------------------------	--

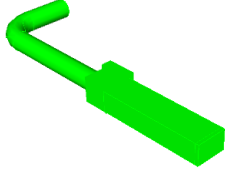
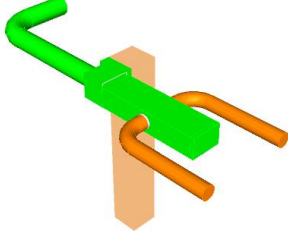
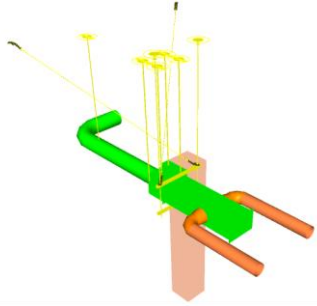

Unifomat Omniclass

200	See D3060	 <p><i>167D3060.10-LOD-200 Supply Air, From lkerd.com</i></p>
300	<p>Modeled as design-specified size, shape, spacing, and location of duct, dampers, fittings, and insulation for risers, mains, and branches;</p> <p>approximate specified allowances for spacing and clearances required for all hangers, supports, vibration and seismic control that are to be utilized in the layout of all risers, mains, and branches;</p> <p>access/code clearance requirements modeled.</p>	 <p><i>168D3060.10-LOD-300 Supply Air, From lkerd.com</i></p>
350	<p>Modeled as actual size, shape, spacing, and location/connections of duct, dampers, fittings, and insulation for risers, mains, and branches;</p> <p>actual size, shape, spacing, and clearances required for all hangers, supports, vibration and seismic control that are utilized in the layout of all risers, mains, and branches;</p> <p>actual floor and wall penetration elements modeled.</p> <p>actual access/code clearance requirements modeled.</p>	 <p><i>169D3060.10-LOD-350 Supply Air, From lkerd.com</i></p>

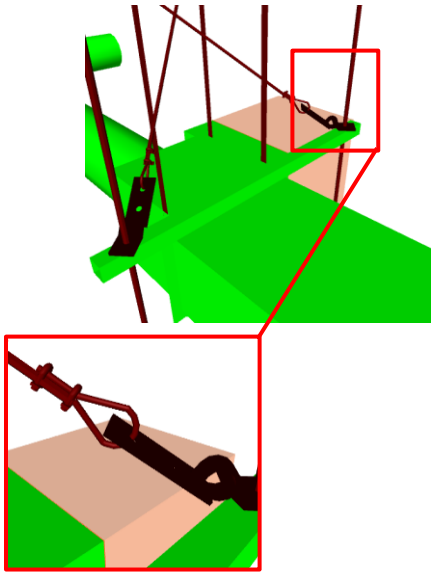

Unifomat Omniclass

<p>400</p>	<p>Supplementary components added to the model required for fabrication and field installation.</p>	 <p>170 D3060.10-LOD-400 Supply Air, From lkerd.com</p>
------------	---	--

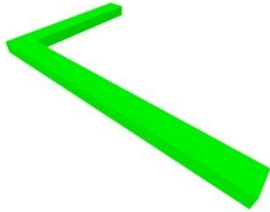

D3060.20 21-04 30 60 20 **Return Air**
 Associated Masterformat Sections: 23 34 00 / 23 31 00 / 23 32 00 / 23 33 00 / 23 37 00
 [See [D3060.10](#)]

D3060.30 21-04 30 60 30 **Exhaust Air**
Includes: Special systems for exhausting air such as kitchen hood, paint booth, and fume hood exhaust systems.
 Associated Masterformat Sections: 23 35 00 / 23 35 13.13 / 23 35 16 / 23 38 00 / 23 38 13 /
 23 38 16 / 23 34 00 / 23 31 00 / 23 32 00 / 23 33 00 / 23 37 00

<p>100</p>	<p>See D30</p>	
<p>200</p>	<p>See D3060</p>	 <p>171 D3060.30-LOD-200 Exhaust Air, From lkerd.com</p>

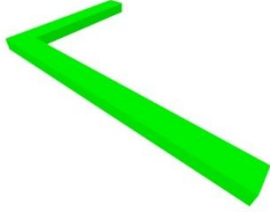

Unifomat Omniclass

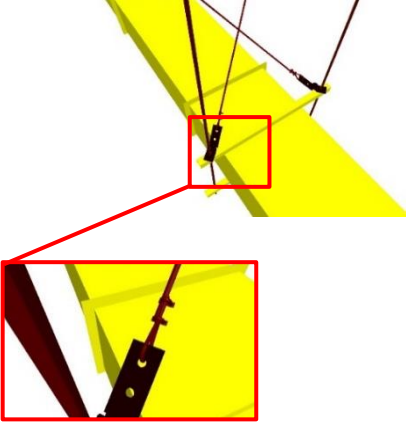
<p>300</p>	<p>Modeled as design-specified size, shape, spacing, location, duct slope (if required), dampers, fittings, insulation for risers, mains, and branches;</p> <p>approximate specified allowances for spacing and clearances required for all hangers, supports, vibration and seismic control that are to be utilized in the layout of all risers, mains, and branches;</p> <p>access/code clearance requirements modeled.</p>	 <p>172 D3060.30-LOD-300 Exhaust Air, From lkerd.com</p>
<p>350</p>	<p>Modeled as actual size, shape, spacing, location, and slope (if required)/connections of duct, dampers, fittings, and insulation for risers, mains, and branches;</p> <p>actual size, shape, spacing, and clearances required for all hangers, supports, vibration and seismic control that are utilized in the layout of all risers, mains, and branches;</p> <p>actual floor and wall penetration elements modeled.</p> <p>actual access/code clearance requirements modeled.</p>	 <p>173 D3060.30-LOD-350 Exhaust Air, From lkerd.com</p>
<p>400</p>	<p>See D3060.10</p>	 <p>174 D3060.30-LOD-400 Exhaust Air, From lkerd.com</p>

D3060.40 21-04 30 60 40 **Outside Air**
Associated Masterformat Sections: 23 34 00 / 23 31 00 / 23 32 00 / 23 33 00 / 23 36 00 / 23 37 00

[See [D3060.10](#)]

D3060.60 21-04 30 60 60 **Air-to-Air Energy Recovery**
Includes: Air-to-air energy recovery units.



Unifomat Omniclass

Associated Masterformat Sections: 23 72 00

[See [D3060.10](#)]

D3060.70 21-04 30 60 70 HVAC Air Cleaning

Associated Masterformat Sections: 23 40 00

[See [D3060.10](#)]

D3060.90 21-04 30 60 90 Ventilation Supplementary Components

Includes expansion fittings, meters, gages, valves, hangers, supports, heat tracing, vibration and seismic controls. Includes: Common work results for HVAC, insulation, and instrumentation and control to be included in ventilation elements above as appropriate.

These components are typically modeled as part of other assemblies listed in the tables above. Do not assign this Unifomat classification unless a supplementary component is modeled independently of another assembly.

Associated Masterformat Sections: 05 45 13 / 23 05 00 / 23 05 29 / 23 05 48 / 23 05 53 / 23 05 63 / 23 05 66 / 23 05 93 / 23 07 00 / 23 09 00

D3070 21-04 30 70 Special Purpose HVAC Systems

Associated Masterformat Sections:

100	See D30	
200	Schematic layout with approximate size, shape, and location of components;	

D3070.10 21-04 30 70 10 Snow Melting

Includes: Electric cables and hydronic piping used for snow and ice control.

Associated Masterformat Sections: 23 83 13 / 23 83 16

100	See D30	
200	See D3070	
300	Modeled as design-specified size, shape, spacing, and location of supplementary components; approximate allowances for spacing and clearances required for all specified hangers, supports, vibration and seismic control that are to be utilized in the layout of all supplementary components; access/code clearance requirements modeled.	
350	Modeled as actual size, shape, spacing, and location/connections of supplementary components; actual size, shape, spacing, and clearances required for all hangers, supports, vibration and seismic control that are utilized in the layout of all supplementary components. actual access/code clearance requirements modeled.	



Unifomat Omniclass

400	Supplementary components added to the model required for fabrication and field installation.	
-----	--	--

D40 21-04 40 Fire Protection

Associated Masterformat Sections:

100	Diagrammatic or schematic model elements; conceptual and/or schematic layout/flow diagram;	
-----	--	--

D4010 21-04 40 10 Fire Suppression

Includes: Fire Suppression Supplementary Components as appropriate.

Associated Masterformat Sections: 01 86 13 / 21 00 00

100	See D40	
200	Schematic layout with approximate size, shape, and location of mains and risers;	

D4010.10 21-04 40 10 10 Water-Based Fire-Suppression

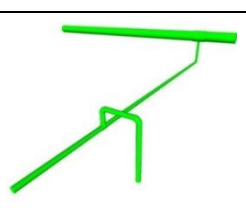

Includes: Systems that use water for fire extinguishing and suppression. Includes piping, fittings, and specialties; hoses, valves, cabinets; fire pumps, accessories, and controls. Includes: Piping, fittings, valves, hangers, supports, other specialties, and sprinklers for fire protection systems. Includes limited area sprinkler systems, fire pumps, accessories, and controls.

Associated Masterformat Sections: 01 86 13 / 21 10 00 / 21 11 00 / 21 12 00 / 21 13 00 / 21 13 13 / 21 13 16 / 21 13 19 / 21 13 23 / 21 13 26 / 21 13 29 / 21 13 36 / 21 13 39 / 21 30 00 / 21 40 00

100	See D40	
200	See D4010	 <p>175D4010.10-LOD-200 Water-Based Fire-Suppression, From lkerd.com</p>

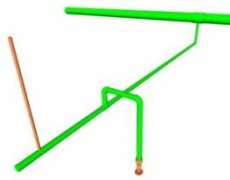

Unifomat Omniclass

<p>300</p>	<p>Modeled as design-specified size, shape, spacing, and location of pipe/slope (if required)/valves/fittings/insulation for risers, mains, and branches/standpipes;</p> <p>approximate allowances for spacing and clearances required for all specified hangers, supports, vibration and seismic control that are to be utilized in the layout of all risers, mains, and branches/standpipes;</p> <p>access/code clearance requirements modeled.</p>	 <p>176 D4010.10-LOD-300 Water-Based Fire-Suppression, From lkerd.com</p>
<p>350</p>	<p>Modeled as actual size, shape, spacing, and location/ slope (if required)/connections of pipe, valves, fittings, and insulation for risers, mains, and branches/standpipes;</p> <p>actual size, shape, spacing, and clearances required for all hangers, supports, vibration and seismic control that are utilized in the layout of all risers, mains, and branches/standpipes;</p> <p>actual floor and wall penetration elements modeled.</p> <p>actual access/code clearance requirements modeled.</p>	 <p>177 D4010.10-LOD-350 Water-Based Fire-Suppression, From lkerd.com</p>
<p>400</p>	<p>Supplementary components added to the model required for fabrication and field installation.</p>	 <p>178 D4010.10-LOD-400 Water-Based Fire-Suppression, From lkerd.com</p>

D4010.50 21-04 40 10 50 Fire-Extinguishing

Includes: Systems that use other than water for fire extinguishing and suppression. Includes piping, fittings, and specialties; valves, accessories, and controls.

Associated Masterformat Sections: 21 20 00 / 21 21 00 / 21 22 00 / 21 23 00 / 21 24 00

[See [D4010.10](#)]

D4010.90 21-04 40 10 90 Fire Suppression Supplementary Components

Includes: Expansion fittings and loops, meters and gages, general-duty valves, hanger and supports, heat tracing, vibration and seismic controls, identification, insulation, and instrumentation and control to be included in fire protection elements above as appropriate.

These components are typically modeled as part of other assemblies listed in the tables above. Do not assign this Unifomat classification unless a supplementary component is modeled independently of another assembly.



Uniformat Omniclass

Associated Masterformat Sections: 05 45 13 / 21 05 00 / 21 05 16 / 21 05 19 / 21 05 23 / 21 05 29 / 21 05 33 / 21 05 48 / 21 05 53 / 21 07 00 / 21 09 00

D4030 21-04 40 30 Fire Protection Specialties

Includes: Firefighting devices and storage cabinets except devices connected to a fire suppression system.

Associated Masterformat Sections: 10 44 00

100	See D40	
200	Schematic layout with approximate size, shape, and location of components;	

D4030.10 21-04 40 30 10 Fire Protection Cabinets

Associated Masterformat Sections: 10 44 13

100	See D40	
200	See D4030	
300	Modeled as design-specified size, shape, spacing, and location of components; approximate allowances for spacing and clearances required for all specified hangers, supports, vibration and seismic control that are to be utilized in the layout of all components; access/code clearance requirements modeled.	
350	Modeled as actual size, shape, spacing, and location/connections of components; actual size, shape, spacing, and clearances required for all hangers, supports, vibration and seismic control that are utilized in the layout of all components. actual access/code clearance requirements modeled.	
400	Supplementary components added to the model required for fabrication and field installation.	

D4030.30 21-04 40 30 30 Fire Extinguishers

Associated Masterformat Sections: 10 44 16

[See [D4030.10](#)]

D4030.50 21-04 40 30 50 Breathing Air Replenishment Systems

Associated Masterformat Sections: 10 44 33

[See [D4030.10](#)]



Unifomat Omniclass

D4030.70 21-04 40 30 70 Fire Extinguisher Accessories

Associated Masterformat Sections: 10 44 43

[See [D4030.10](#)]

D50 21-04 50 Electrical

Associated Masterformat Sections: 26 00 00 / 01 86 26

100	Diagrammatic or schematic model elements: conceptual and/or schematic layout;	
-----	--	--

D5010 21-04 50 10 Facility Power Generation

Includes: Power Generation Supplementary Components as appropriate.

Associated Masterformat Sections: 01 86 26

100	See D50	
200	Schematic layout with approximate size, shape, and location of equipment;	

D5010.10 21-04 50 10 10 Packaged Generator Assemblies

Includes: Generator, frequency changers, and rotary converters and uninterruptible power units.

Associated Masterformat Sections: 26 32 00 / 26 32 13 / 26 32 16 / 26 32 19 / 26 32 23 / 26 32 26 / 26 32 29 / 26 32 33

100	See D50	
200	See D5010	 <p>179 D5010.10-LOD-200 Packaged Generator Assemblies, From lkerd.com</p>

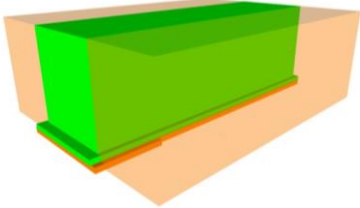
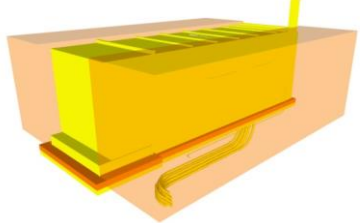
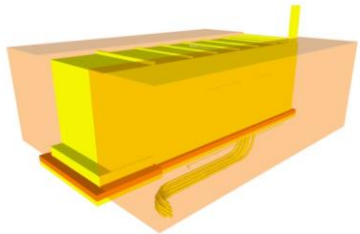

Unifomat Omniclass

<p>300</p>	<p>Modeled as design-specified size, shape, spacing, and location of equipment and associated components;</p> <p>approximate allowances for spacing and clearances required for all specified supports and seismic control;</p> <p>access/code clearance requirements modeled.</p>	 <p>180 D5010.10-LOD-300 Packaged Generator Assemblies, From lkerd.com</p>
<p>350</p>	<p>Modeled as actual size, shape, spacing, and location of equipment and associated components;</p> <p>actual size, shape, spacing, and location for supports and seismic control;</p> <p>actual size, shape, and location/connections of equipment and support structure/pads.</p> <p>actual access/code clearance requirements modeled.</p>	 <p>181 D5010.10-LOD-350 Packaged Generator Assemblies, From lkerd.com</p>
<p>400</p>	<p>Supplementary components added to the model required for fabrication and field installation.</p>	 <p>182 D5010.10-LOD-400 Packaged Generator Assemblies, From lkerd.com</p>

D5010.20 21-04 50 10 20 Battery Equipment

Includes: Batteries, battery racks, battery chargers, static power converters, uninterruptible power supplies, and accessories.

Associated Masterformat Sections: 26 33 00 / 26 33 13 / 26 33 16 / 26 33 19 / 26 33 23 / 26 33 33 / 26 33 43 / 26 33 46 / 26 33 53

[See [D5010.10](#)]

D5010.30 21-04 50 10 30 Photovoltaic Collectors

Includes: Solar cells to convert sunlight to electricity.

Associated Masterformat Sections: 26 31 00

[See [D5010.10](#)]



Unifomat Omniclass

D5010.40 21-04 50 10 40 Fuel Cells

Includes: Fuel cell electricity generating equipment.

Associated Masterformat Sections: 48 18 00

[See [D5010.10](#)]

D5010.60 21-04 5010 60 Power Filtering and Conditioning TBD

D5010.70 21-04 50 10 70 Transfer Switches

Includes: Switches that transfer from one source of electricity to another.

Associated Masterformat Sections: 26 36 00

[See [D5010.10](#)]

D5010.90 21-05 50 10 90 Facility Power Generation Supplementary Components TBD

D5020 21-04 50 20 Electrical Service and Distribution

Includes: Electrical Service and Distribution Supplementary Components as appropriate.

Associated Masterformat Sections: 01 86 26

100	See D50	
200	Schematic layout with approximate size, shape, and location of equipment;	

D5020.10 21-04 50 20 10 Electrical Service Entrance

Includes: Meters, substations, transformers, switchgear, switchboards, and protective devices where electrical power enters structure.

Associated Masterformat Sections: 26 21 00 / 26 16 00 / 26 11 00 / 26 12 00 / 26 22 00 / 26 13 00 / 22 23 00 / 26 18 00 / 22 28 00

100	See D50	
200	See D5020	
300	Modeled as design-specified size, shape, spacing, and location of equipment and associated components; approximate allowances for spacing and clearances required for all specified supports and seismic control; access/code clearance requirements modeled.	

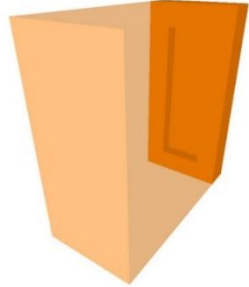
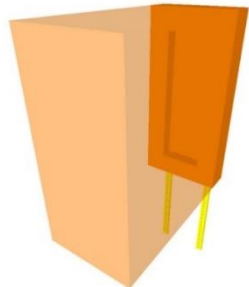
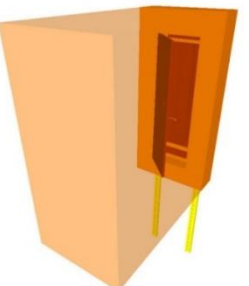

Unifomat Omniclass

		 <p><i>183 D5020.10-LOD-300 Electrical Service Entrance, From lkerd.com</i></p>
350	<p>Modeled as actual size, shape, spacing, and location of equipment and associated components;</p> <p>actual size, shape, spacing, and location for supports and seismic control;</p> <p>actual size, shape, and location/connections of equipment and support structure/pads.</p> <p>actual access/code clearance requirements modeled.</p>	 <p><i>184 D5020.10-LOD-350 Electrical Service Entrance, From lkerd.com</i></p>
400	<p>Supplementary components added to the model required for fabrication and field installation.</p>	 <p><i>185 D5020.10-LOD-400 Electrical Service Entrance, From lkerd.com</i></p>

D5020.30 21-04 50 20 30 Power Distribution

Includes: Bus assemblies, distribution equipment, and electrical wiring system to distribute electrical power to switchboards, panelboards, and motor control centers.

Associated Masterformat Sections: 26 20 00 / 26 24 00 / 26 24 13 / 26 24 16 / 26 24 19 / 26 25 00 / 26 27 00 / 26 27 16 / 26 05 33 / 26 05 43 / 26 05 36 / 26 05 13

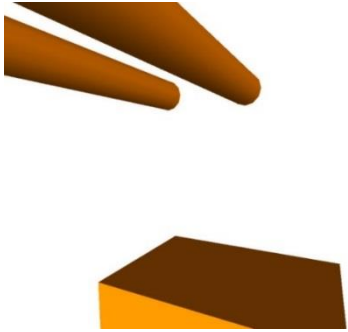
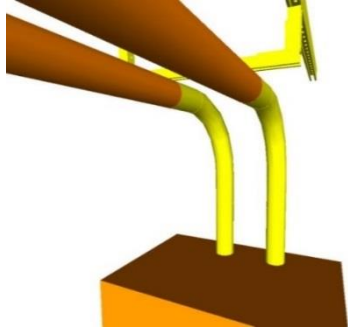
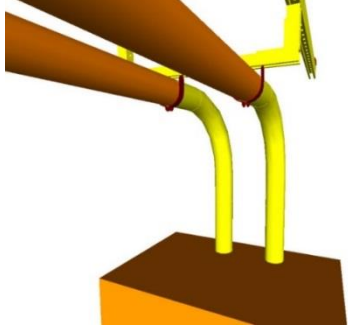

Unifomat Omniclass

100	See D50	
200	See D5020	
300	<p>Modeled as design-specified size, shape, spacing, and location of raceways, boxes, enclosures, and equipment; approximate allowances for spacing and clearances required for all specified hangers, supports and seismic control; access/code clearance requirements modeled.</p>	 <p><i>186 D5020.30-LOD-300 Power Distribution, From lkerd.com</i></p>
350	<p>Modeled as actual size, shape, spacing, and location of raceways, boxes, and enclosures; actual size, shape, spacing, and location for supports and seismic control; actual size, shape, and location/connections of equipment and support structure/pads; actual floor and wall penetration elements are modeled. actual access/code clearance requirements modeled.</p>	 <p><i>187 D5020.30-LOD-350 Power Distribution, From lkerd.com</i></p>
400	<p>Supplementary components added to the model required for fabrication and field installation.</p>	 <p><i>188 D5020.30-LOD-400 Power Distribution, From lkerd.com</i></p>



Unifomat Omniclass

D5020.70 21-04 50 20 70 Facility Grounding

Includes: Raceways, wiring and devices for grounding and bonding an electrical distribution system.

Associated Masterformat Sections: 26 05 26 / 26 05 33 / 26 05 13

100	See D50	
200	See D5020	
300	Modeled as design-specified size, shape, spacing, and location of raceways, boxes, enclosures, and the electrical equipment and end-devices served; approximate allowances for spacing and clearances required for all specified hangers, supports, and seismic control; access/code clearance requirements modeled.	
350	Modeled as actual size, shape, spacing, and location of raceways, boxes, enclosures, and the electrical equipment and end-devices served; actual size, shape, spacing, and location for supports and seismic control; actual floor and wall penetration elements are modeled. actual access/code clearance requirements modeled.	
400	Supplementary components added to the model required for fabrication and field installation.	

D5020.90 21-04 50 20 90 Electrical Service and Distribution Supplementary Components

Includes: Grounding and bonding, hanger and supports, raceways and boxes, cable trays, utility poles, vibration and seismic controls, identification, wiring connectors, and instrumentation and control to be included in electrical service and distribution systems elements above as appropriate.

Associated Masterformat Sections: 05 45 16 / 26 05 00 / 26 05 26 / 26 05 29 / 26 05 33 / 26 05 36 / 26 05 46 / 26 05 48 / 26 05 53 / 26 05 83 / 26 09 00

100	See D50	
200	See D5020	
300	Modeled as design-specified size, shape, spacing, and location of raceways, boxes, enclosures, and the electrical equipment and end-devices served; approximate allowances for spacing and clearances required for all specified hangers, supports, and seismic control; access/code clearance requirements modeled.	
350	Modeled as actual size, shape, spacing, and location of raceways, boxes, enclosures, and the electrical equipment and end-devices served; actual size, shape, spacing, and location for supports and seismic control;	



Unifomat Omniclass

	actual floor and wall penetration elements are modeled. actual access/code clearance requirements modeled.	
400	Supplementary components added to the model required for fabrication and field installation.	

D5030 21-04 50 30 General Purpose Electrical Power

Includes: General Purpose Electrical Power Supplementary Components as appropriate.

Associated Masterformat Sections: 01 86 26

100	See D50	
200	Schematic layout with approximate size, shape, and location of equipment;	

D5030.10 21-04 50 30 10 Branch Wiring System

Includes: Raceways, ducts, cable trays, and wiring to deliver power from branch panelboards to the point of use.

Associated Masterformat Sections: 26 05 33 / 26 05 43 / 26 05 36 / 26 05 19

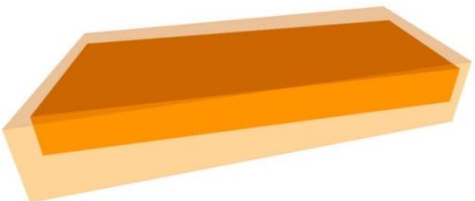
100	See D50	
200	See D5030	
300	Modeled as design-specified size, shape, spacing, and location of raceways, boxes, and enclosures; approximate allowances for spacing and clearances required for all specified hangers, supports and seismic control; access/code clearance requirements modeled.	 <p>189 D5030.10-LOD-300 Branch Wiring System, From lkerd.com</p>

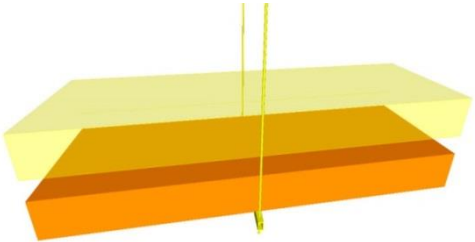

Unifomat Omniclass

350	<p>Modeled as actual size, shape, spacing, and location of raceways, boxes, enclosures;</p> <p>actual size, shape, spacing, and location for supports and seismic control;</p> <p>actual floor and wall penetration elements are modeled.</p> <p>actual access/code clearance requirements modeled.</p>	 <p><i>190 D5030.10-LOD-350 Branch Wiring System, From lkerd.com</i></p>
400	<p>Supplementary components added to the model required for fabrication and field installation.</p>	

D5030.50 21-04 50 30 50 Wiring Devices

Includes: Electrical devices at point of use including electrical outlets and switches.

Associated Masterformat Sections: 26 27 26

100	See D50	
200	See D5030	
300	<p>Modeled as design-specified size, shape, spacing, and location of outlet boxes and devices;</p> <p>access/code clearance requirements modeled.</p>	
350	<p>Modeled as actual size, shape, spacing, and location of outlet boxes and devices.</p> <p>actual access/code clearance requirements modeled.</p>	
400	<p>Supplementary components added to the model required for fabrication and field installation.</p>	

D5030.90 21-04 50 30 90 General Purpose Electrical Power Supplementary Components

Includes: Grounding and bonding, hanger and supports, raceways and boxes, cable trays, vibration and seismic controls, identification, wiring connectors, and instrumentation and control to be included in general purpose electrical power elements above as appropriate.

Associated Masterformat Sections: 05 45 16 / 26 05 00 / 26 05 26 / 26 05 29 / 26 05 33 / 26 05 36 / 26 05 48 / 26 05 53 / 26 05 83 / 26 09 00

100	See D50	
200	See D5030	



Unifomat Omniclass

300	Modeled as design-specified size, shape, spacing, and location of outlet boxes and devices; access/code clearance requirements modeled.	
350	Modeled as actual size, shape, spacing, and location of outlet boxes and devices. actual access/code clearance requirements modeled.	
400	Supplementary components added to the model required for fabrication and field installation.	

D5040 21-04 50 40 Lighting

Includes: Lighting Supplementary Components as appropriate.

Associated Masterformat Sections: 26 50 00 / 01 86 26

100	See D50	
200	Schematic layout with approximate size, shape, and location of equipment;	

D5040.10 21-04 50 40 10 Lighting Control

Includes: Clock and calendar, photoelectric switches, occupancy sensors, and light-leveling control devices.

Associated Masterformat Sections: 26 09 23 / 26 09 26 / 26 09 33 / 26 09 36 / 26 09 43 / 26 09 61

100	See D50	
200	See D5040	
300	Modeled as design-specified size, shape, spacing, and location of enclosures, equipment, and devices; access/code clearance requirements modeled.	
350	Modeled as actual size, shape, spacing, and location of enclosures, equipment, and control devices; actual size, shape, and location/connections of equipment and control devices. actual access/code clearance requirements modeled.	
400	Supplementary components added to the model required for fabrication and field installation.	

D5040.20 21-04 50 40 20 Branch Wiring for Lighting

Includes: Raceways, ducts, cable trays, and wiring beyond branch circuit panelboards to lighting fixtures.



Unifomat Omniclass

Associated Masterformat Sections: 26 05 33 / 26 05 43 / 26 05 36 / 26 05 19 / 26 27 26

100	See D50	
200	See D5040	
300	Modeled as design-specified size, shape, spacing, and location of raceways, boxes, and enclosures to fixture locations; approximate allowances for spacing and clearances required for all specified hangers, supports, and seismic control. access/code clearance requirements modeled.	
350	Modeled as actual size, shape, spacing, and location of raceways, boxes, and enclosures to fixture locations; actual size, shape, spacing, and location for supports and seismic control; actual floor and wall penetration elements are modeled. actual access/code clearance requirements modeled.	
400	Supplementary components added to the model required for fabrication and field installation.	

D5040.50 21-04 50 40 50 Lighting Fixtures

Includes: Luminaires, lighting equipment, ballasts, and accessories. Includes fluorescent, high intensity discharge, incandescent, mercury vapor, neon, and sodium vapor lighting.

Associated Masterformat Sections: 26 50 00 / 26 51 00 / 26 52 00 / 26 53 00 / 26 54 00 /
26 55 00 / 26 55 23 / 26 55 29 / 26 55 33 / 26 55 36 / 26 55 39 / 26 55 53 / 26 55 59 /
26 55 61 / 26 55 63 / 26 55 70

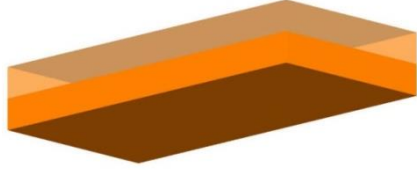
100	See D50	
200	See D5040	
300	Modeled as design-specified size, shape, spacing, and location of lighting fixtures; approximate allowances for spacing and clearances required for all specified hangers, supports and seismic control; access/code clearance requirements modeled.	 <p>191 D5040.50-LOD-300 Lighting Fixtures, From lkerd.com</p>

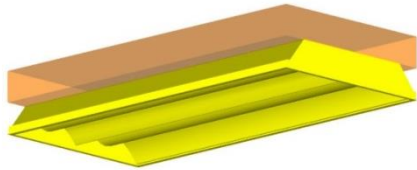

Unifomat Omniclass

350	<p>Modeled as actual size, shape, spacing, and location of lighting fixtures.</p> <p>actual size, shape, spacing, and location for supports and seismic control.</p> <p>actual access/code clearance requirements modeled.</p>	 <p><i>192 D5040.50-LOD-350 Lighting Fixtures, From lkerd.com</i></p>
400	Supplementary components added to the model required for fabrication and field installation.	

D5040.90 21-04 50 40 90 Lighting Supplementary Components TBD

D5080 21-04 50 80 Miscellaneous Electrical Systems

Includes: Miscellaneous Electrical Systems Supplementary Components as appropriate.

Associated Masterformat Sections:

100	See D50	
200	Schematic layout with approximate size, shape, and location of equipment;	

D5080.10 21-04 50 80 10 Lightning Protection

Includes: Wiring and equipment for lightning protection.

Associated Masterformat Sections: 26 41 00 / 01 86 26 / 26 41 13 / 26 41 16 / 26 41 19 / 26 41 23

100	See D50	
200	See D5080	
300	<p>Modeled as design-specified size, shape, spacing, and location of raceways, boxes, enclosures including the electrical equipment and end-devices served;</p> <p>approximate allowances for spacing and clearances required for all specified hangers, supports and seismic control;</p> <p>access/code clearance requirements modeled.</p>	



Uniformat Omniclass

350	Modeled as actual size, shape, spacing, and location of raceways, boxes, enclosures including the electrical equipment, fixtures, and end-devices served actual size, shape, spacing, and location for supports and seismic control; actual size, shape, and location/connections of equipment and support structure/pads; actual floor and wall penetration elements are modeled. actual access/code clearance requirements modeled.	
400	Supplementary components added to the model required for fabrication and field installation.	

D5080.40 21-04 50 80 40 Cathodic Protection TBD

D5080.70 21-04 50 80 70 Transient Voltage Suppression

Includes: Devices to protect against voltage surges on electrical distribution systems.

Associated Masterformat Sections: 26 43 00

100	See D50	
200	See D5080	
300	Modeled as design-specified size, shape, spacing, and location of equipment; approximate allowances for spacing and clearances required for all specified hangers, supports and seismic control; access/code clearance requirements modeled.	
350	Modeled as actual size, shape, spacing, and location of the equipment; actual size, shape, spacing, and location for supports and seismic control. actual access/code clearance requirements modeled.	
400	Supplementary components added to the model required for fabrication and field installation.	

D5080.90 21-04 50 80 90 Miscellaneous Electrical Systems Supplementary Components TBD

D60 21-04 60 Communications

Associated Masterformat Sections: 27 00 00 / 01 86 29

[See [Fundamental LOD Definitions](#)]



Unifomat Omniclass

D6010 21-04 60 10 Data Communications

Includes: Communications Supplementary Components as appropriate.

Associated Masterformat Sections: 27 20 00 / 01 86 29

[See [Fundamental LOD Definitions](#)]

D6010.10 21-04 60 10 10 Data Communications Network Equipment

Includes: Switching and routing equipment for data communications.

Associated Masterformat Sections: 27 21 00 / 27 21 13 / 27 21 16 / 27 21 29 / 27 21 33

100	See D50	
200	See D5010	
300	Modeled as design-specified size, shape, spacing, and location of equipment and associated components; approximate allowances for spacing and clearances required for all specified supports and seismic control; access/code clearance requirements modeled.	
350	Modeled as actual size, shape, spacing, and location of equipment and associated components; actual size, shape, spacing, and location for supports and seismic control; actual size, shape, and location/connections of equipment and support structure/pads. actual access/code clearance requirements modeled.	
400	Supplementary components added to the model required for fabrication and field installation.	

D6010.20 21-04 60 10 20 Data Communications Hardware

Includes: Computer equipment for data communications.

Associated Masterformat Sections: 27 22 00 / 07 22 13 / 07 22 16 / 07 22 19 / 07 22 23 / 07 22 26 / 07 22 29

100	See D50	
200	See D5010	



Unifomat Omniclass

300	Modeled as design-specified size, shape, spacing, and location of equipment and associated components; approximate allowances for spacing and clearances required for all specified supports and seismic control; access/code clearance requirements modeled.	
350	Modeled as actual size, shape, spacing, and location of equipment and associated components; actual size, shape, spacing, and location for supports and seismic control; actual size, shape, and location/connections of equipment and support structure/pads. actual access/code clearance requirements modeled.	
400	Supplementary components added to the model required for fabrication and field installation.	

D6010.30 21-04 60 10 30 Data Communications Peripheral Data Equipment

Includes: Additional equipment for data communications.

Associated Masterformat Sections: 27 24 00 / 27 24 13 / 27 24 26 / 27 24 19 / 27 24 23 / 27 24 26 / 27 24 29

100	See D50	
200	See D5010	
300	Modeled as design-specified size, shape, spacing, and location of equipment and associated components; approximate allowances for spacing and clearances required for all specified supports and seismic control; access/code clearance requirements modeled.	
350	Modeled as actual size, shape, spacing, and location of equipment and associated components; actual size, shape, spacing, and location for supports and seismic control; actual size, shape, and location/connections of equipment and support structure/pads. actual access/code clearance requirements modeled.	



Unifomat Omniclass

400	Supplementary components added to the model required for fabrication and field installation.	
-----	--	--

D6020 21-04 60 20 Voice Communications

Includes: Communications Supplementary Components as appropriate.

Associated Masterformat Sections: 27 30 00 / 01 86 29

[See [Fundamental LOD Definitions](#)]

D6030 21-04 60 30 Audio-Video Communication

Includes: Communications Supplementary Components as appropriate.

Associated Masterformat Sections: 27 40 00 / 01 86 29

[See [Fundamental LOD Definitions](#)]

D6060 21-04 60 60 Distributed Communications and Monitoring

Includes: Communications Supplementary Components as appropriate.

Associated Masterformat Sections: 27 50 00 / 01 86 29

[See [Fundamental LOD Definitions](#)]

D6090 21-04 60 90 Communications Supplementary Components

[See [Fundamental LOD Definitions](#)]

D70 21-04 70 Electronic Safety and Security

Associated Masterformat Sections: 28 00 00 / 01 86 33

[See [Fundamental LOD Definitions](#)]

D7010 21-04 70 10 Access Control and Intrusion Detection

Includes: Electronic Safety and Security Supplementary Components as appropriate.

Associated Masterformat Sections: 28 10 00 / 01 86 33

[See [Fundamental LOD Definitions](#)]

D7030 21-04 70 30 Electronic Surveillance

Includes: Equipment for detecting and controlling access by persons to a facility site, building, or within a building. Includes Electronic Safety and Security Supplementary Components as appropriate.

Associated Masterformat Sections: 28 20 00 / 01 86 33



Unifomat Omniclass

[See [Fundamental LOD Definitions](#)]

D7050 21-04 70 50 Detection and Alarm

Includes: Equipment for detecting hazardous conditions in a building or on a facility site and communicating an alarm signal. Includes alarm devices, detection devices, safety switches, and associated items. Includes Electronic Safety and Security Supplementary Components as appropriate.

Associated Masterformat Sections: 28 30 00 / 01 86 33

D7070 21-04 70 70 Electronic Monitoring and Control

Includes: Electronic Safety and Security Supplementary Components as appropriate.

Associated Masterformat Sections: 28 46 00 / 01 86 33

D7090 21-04 70 90 Electronic Safety and Security Supplementary Components

These components are typically modeled as part of other assemblies listed in the tables above. Do not assign this Unifomat classification unless a supplementary component is modeled independently of another assembly.

Associated Masterformat Sections:

D80 21-04 80 Integrated Automation

Associated Masterformat Sections: 25 00 00 / 01 86 23

[See [Fundamental LOD Definitions](#)]

D8010 21-04 80 10 Integrated Automation Facility Controls

Includes: Hardware and/or software that allows the building automation system to monitor and control other facility equipment and systems. Includes Integrated Automation Supplementary Components as appropriate.

Associated Masterformat Sections: 25 50 00 / 01 86 23

[See [Fundamental LOD Definitions](#)]



Unifomat Omniclass

E 21-05 00 00 EQUIPMENT & FURNISHINGS

Associated Masterformat Sections: 01 87 00

E10 21-05 10 Equipment

Associated Masterformat Sections: 11 00 00 / 01 87 13

100	Diagrammatic or schematic model elements: conceptual and/or schematic layout; design performance parameters as defined in the BXP to be associated with model elements as non-graphic information.	
-----	--	--

E1010 21-05 10 10 Vehicle and Pedestrian Equipment

Associated Masterformat Sections: 11 10 00

100	See E10	
200	Schematic layout with approximate size, shape, and location of equipment; design performance parameters as defined in the BXP to be associated with model elements as non-graphic information.	

E1010.10 21-05 10 10 10 Vehicle Servicing Equipment

Includes: Equipment associated with vehicle service facilities.

Associated Masterformat Sections: 11 11 00 / 11 11 19 / 11 11 23 / 11 11 26

100	See E10	
200	See E1010	
300	Modeled as design-specified size, shape, spacing, and location of equipment and associated components; approximate allowances for spacing and clearances required for all specified supports and seismic control; access/code clearance requirements modeled.	
350	Modeled as actual size, shape, spacing, and location of equipment and associated components; actual size, shape, spacing, and location for supports and seismic control; actual size, shape, and location of service connections and support structure/pads. Actual access/code clearance requirements modeled.	
400	Supplementary components added to the model required for fabrication and field installation.	



Unifomat Omniclass

E1010.30 21-05 10 10 30 Interior Parking Control Equipment

Includes: Equipment associated with the control of movement of vehicle parking.

Associated Masterformat Sections: 11 12 00 / 11 12 13 / 11 12 16 / 11 12 23 / 11 12 26 / 11 12 33

[See [E1010.10](#)]

E1010.50 21-05 10 10 50 Loading Dock Equipment

Includes: Equipment for the protection of service docks and for the loading and unloading of service vehicles.

Associated Masterformat Sections: 11 13 00 / 11 13 13 / 11 13 16 / 11 13 19.13 / 11 13 19.23 / 11 13 26

[See [E1010.10](#)]

E1010.70 21-05 10 10 70 Interior Pedestrian Control Equipment

Includes: Equipment associated with the control of movement of pedestrians.

Associated Masterformat Sections: 11 14 00 / 11 14 13 / 11 14 16 / 11 14 26 / 11 14 43 / 11 14 53

[See [E1010.10](#)]

E1030 21-05 10 30 Commercial Equipment

Associated Masterformat Sections: 11 20 00

[See [E1010](#)]

E1030.10 21-05 10 30 10 Mercantile and Service Equipment

Includes: Equipment used in retail and service stores.

Associated Masterformat Sections: 11 21 00 / 11 21 13 / 11 21 23 / 11 21 33 / 11 21 43 / 11 21 53

[See [E1010.10](#)]

E1030.20 21-05 10 30 20 Vault Equipment

Includes: Equipment specifically designed for money or valuable material storage, including vault ventilators and specialized security equipment.

Associated Masterformat Sections: 11 16 00 / 11 16 13 / 11 16 16 / 11 16 23

[See [E1010.10](#)]

E1030.25 21-05 10 30 25 Teller and Service Equipment

Includes: Equipment specifically designed for handling and transfer of money and other high-security items.

Associated Masterformat Sections: 11 17 00 / 11 17 13 / 11 17 16 / 11 17 23 / 11 17 33 / 11 17 36

[See [E1010.10](#)]



Unifomat Omniclass

E1030.30 21-05 10 30 30 Refrigerated Display Equipment

Includes: Display cases that include refrigeration.

Associated Masterformat Sections: 11 22 00

[See [E1010.10](#)]

E1030.35 21-05 10 30 35 Commercial Laundry and Dry Cleaning Equipment

Includes: Equipment for commercial laundry and dry-cleaning operations including coin-operated equipment.

Associated Masterformat Sections: 11 23 00 / 11 23 13 / 11 23 16 / 11 23 19 / 11 23 23 /
11 23 26 / 11 23 33 / 11 23 43

[See [E1010.10](#)]

E1030.40 Maintenance Equipment

Includes: Built-in and free-standing equipment for building maintenance.

Associated Masterformat Sections: 11 24 00 / 11 24 13 / 11 24 16 / 11 24 19 / 11 24 23.13

[See [E1010.10](#)]

E1030.50 21-05 10 30 50 Hospitality Equipment

Includes: Specialized equipment for the purpose of registering, admitting, and controlling rooms and other information at hotels, motels, hospitals, and other similar facilities.

Associated Masterformat Sections: 11 25 00 / 11 25 13

[See [E1010.10](#)]

E1030.55 21-05 10 30 55 Unit Kitchens

Includes: Manufactured units incorporating plumbing fixtures, appliances, casework and countertops.

Associated Masterformat Sections: 11 26 00

[See [E1010.10](#)]

E1030.60 21-05 10 30 60 Photographic Processing Equipment

Includes: Photographic film processing equipment and other products for darkroom use.

Associated Masterformat Sections: 11 27 00 / 11 27 13 / 11 27 16

[See [E1010.10](#)]

E1030.70 21-05 10 30 70 Postal, Packaging and Shipping Equipment

Includes: Equipment for normal mailing, packaging, shipping, and delivery operations for professional, commercial, and institutional applications.

Associated Masterformat Sections: 11 29 00 / 11 29 23 / 11 29 33 / 11 29 55 / 11 28 23

[See [E1010.10](#)]



Unifomat Omniclass

E1030.75 21-05 10 30 75 Office Equipment

Includes: Computers, printers, copiers, drafting equipment, plotters, carto-stereographs, and other equipment used in offices.

Associated Masterformat Sections: 11 28 00 / 11 28 13 / 11 28 16 / 11 28 19 / 11 28 23

[See [E1010.10](#)]

E1030.80 21-05 10 30 80 Foodservice Equipment

Includes: Equipment used for liquid and solid food storage, preparation, display, serving, and clean-up in commercial and institutional kitchens and bars.

Associated Masterformat Sections: 11 40 00 / 11 41 00 / 11 41 13 / 11 41 23 / 11 41 26 /
11 41 33 / 11 42 00 / 11 43 00 / 11 41 13 / 11 41 16 / 11 44 00 / 11 44 13 / 11 44 16 /
11 46 00 / 11 46 13 / 11 46 16 / 11 46 19 / 11 47 00 / 11 48 00 / 11 48 13

[See [E1010.10](#)]

E1040 21-05 10 40 Institutional Equipment

Associated Masterformat Sections: 11 50 00

[See [E1010](#)]

E1040.10 21-05 10 40 10 Educational and Scientific Equipment

Includes: Equipment associated with libraries, education facilities, laboratories, planetariums, observatories, and museums.

Associated Masterformat Sections: 11 50 00 / 11 51 00 / 11 51 13 / 11 51 16 / 11 51 19 /
11 51 23 / 11 52 00 / 11 52 13 / 11 52 16 / 11 52 19 / 11 53 00 / 11 53 13 / 11 53 16 /
11 53 19 / 11 53 23 / 11 53 33 / 11 53 43 / 11 53 53 / 11 55 00 / 11 55 13 / 11 55 16 /
11 56 00 / 11 56 13 / 11 57 00 / 11 59 00 / 11 95 00 / 11 95 13

[See [E1010.10](#)]

E1040.20 21-05 10 40 20 Healthcare Equipment

Includes: Specialized equipment for healthcare facilities for humans and animals. Includes film illuminators, fluoroscopes, hubbard tubs, radio isotopic equipment, and surgical equipment.

Associated Masterformat Sections: 11 70 00 / 05 45 23 / 11 71 00 / 11 72 00 / 11 73 00 /
11 74 00 / 11 75 00 / 11 76 00 / 11 77 00 / 11 78 00 / 11 78 13 / 11 78 16 / 11 78 19 /
11 79 00

[See [E1010.10](#)]

E1040.40 21-05 10 40 40 Religious Equipment

Includes: Built-in and free-standing religious equipment, including baptistry and chancel fittings.

Associated Masterformat Sections: 11 91 00 / 11 91 13

[See [E1010.10](#)]

E1040.60 21-05 10 40 60 Security Equipment

Includes: Equipment specifically designed for secure operations.



Unifomat Omniclass

Associated Masterformat Sections: 11 18 00 / 11 18 13 / 11 18 16 / 11 18 23

[See [E1010.10](#)]

E1040.70 21-05 10 40 70 Detention Equipment

Includes: Equipment specifically designed for detention facilities.

Associated Masterformat Sections: 11 19 00 / 01 87 13 / 11 19 13 / 11 19 16

[See [E1010.10](#)]

E1060 21-05 10 60 Residential Equipment

Includes: Built-in and free-standing appliances and other components specifically for residential use.

Associated Masterformat Sections: 11 30 00

[See [E1010](#)]

E1060.10 21-05 10 60 10 Residential Appliances

Associated Masterformat Sections: 11 31 00 / 11 31 13 / 11 31 23

[See [E1010.10](#)]

E1060.50 21-05 10 60 50 Residential Stairs

Associated Masterformat Sections: 11 33 00

[See [B1080](#)]

E1060.70 21-05 10 60 70 Residential Ceiling Fans

Associated Masterformat Sections: 11 34 00

[See [E1010.10](#)]

E1070 21-05 10 70 Entertainment and Recreational Equipment

Includes: Equipment for use in athletic, recreational, and therapeutic activities.

Associated Masterformat Sections:

[See [E1010](#)]

E1070.10 21-05 10 70 10 Theater and Stage Equipment

Includes: Equipment for support of theatrical, instrumental, and voice programs. Includes cycloramas, entertainment ticket dispensers, scenery and flats, and tormentors.

Associated Masterformat Sections: 11 61 00 / 11 61 13 / 11 61 23 / 11 61 33 / 11 61 43

[See [E1010.10](#)]



Unifomat Omniclass

E1070.20 21-05 10 70 20 **Musical Equipment**
Includes: Musical instruments, including prefabricated and field assembled instruments.
Associated Masterformat Sections: 11 62 00 / 11 62 13 / 11 62 16 / 11 62 19
[See [E1010.10](#)]

E1070.50 21-05 10 70 50 **Athletic Equipment**
Includes: Equipment for use in interior athletic and exercise activities.
Associated Masterformat Sections: 11 66 00 / 11 66 13 / 11 66 23 / 11 66 43 / 11 66 53
[See [E1010.10](#)]

E1070.60 21-05 10 70 60 **Recreational Equipment**
Includes: Equipment for use in recreational activities. Includes curling rinks and pistol and rifle range equipment.
Associated Masterformat Sections: 11 67 00 / 11 67 13 / 11 67 23 / 11 67 33 / 11 67 43 / 11 67 53
[See [E1010.10](#)]

E1090 21-05 10 90 **Other Equipment**
Associated Masterformat Sections: 11 90 00
[See [E1010](#)]

E1090.10 21-05 10 90 10 **Solid Waste Handling Equipment**
Includes: Equipment involving the collection, shredding, compaction, removal and incineration of trash and other solid waste
Associated Masterformat Sections: 11 82 00 / 01 87 13 / 11 82 13 / 11 82 19 / 11 82 23 / 11 82 26 / 11 82 29 / 11 82 33 / 11 82 36
[See [E1010.10](#)]

E1090.30 21-05 10 90 30 **Agricultural Equipment**
Includes: Equipment related to land cultivating, raising crops, and feeding, breeding, and raising of livestock.
Associated Masterformat Sections: 11 92 00 / 11 92 13 / 11 92 16 / 11 92 19 / 11 92 23
[See [E1010.10](#)]

E1090.40 21-05 10 90 40 **Horticultural Equipment**
Includes: Equipment related to cultivating flowers, fruits, vegetables, or ornamental plants.
Associated Masterformat Sections: 11 93 00 / 11 93 13 / 11 93 16 / 11 93 19 / 11 93 23 / 11 93 26 / 11 93 29 / 11 93 33 / 32 86 00
[See [E1010.10](#)]

E1090.60 21-05 10 90 60 **Decontamination Equipment**
Includes: Equipment associated with decontamination operations.
Associated Masterformat Sections:



Unifomat Omniclass

[See [E1010.10](#)]

E20 21-05 20 Furnishings

Associated Masterformat Sections: 12 00 00 / 01 87 16

100	A schematic model element or symbol that is not distinguishable by type or material. Types, layouts, and locations are still flexible.	
-----	---	--

E2010 21-05 20 10 Fixed Furnishings

Associated Masterformat Sections:

100	See E20	
200	Generic model elements with approximate nominal size. Placement and quantity remains flexible. •	

E2010.10 21-05 20 10 10 Fixed Art

Includes: Interior and exterior fixed art objects.

Associated Masterformat Sections: 12 10 00 / 12 11 00 / 12 12 00 / 12 12 23 / 12 12 26 / 12 14 00 / 12 17 00 / 12 19 00

100	See E20	
200	See E2010	
300	Modeled types with specific dimensions, locations, and quantities.	
350	Include any applicable service or installation clearances. Include any applicable support and connection points.	
400	Supplementary components added to the model required for fabrication and field installation.	

E2010.20 21-05 20 10 20 Window Treatments

Includes: Interior window coverings and associated hardware and controls.

Associated Masterformat Sections: 12 20 00 / 12 21 00 / 12 22 00 / 12 23 00 / 12 24 00 / 12 25 00

[See [E2010.10](#)]



Unifomat Omniclass

E2010.30 21-05 20 10 30 Casework

Includes: Custom and manufactured stock design steel, wood, and laminate faced cabinets and other casework units. Includes countertops with integral sinks, fixtures and accessories.

Associated Masterformat Sections: 12 30 00 / 12 35 00 / 12 35 17 / 12 35 25 / 12 35 30 / 12 35 33 / 12 35 50 / 12 35 53 / 12 35 59 / 12 35 70 / 12 35 91 / 12 36 00

[See [E2010.10](#)]

E2010.70 21-05 20 10 70 Fixed Multiple Seating

Includes: Fixed, and telescoping seating for theaters, auditoriums, lecture halls, stadiums, arenas, gymnasiums, religious buildings, restaurants, and other facilities where multiple seating is required.

Associated Masterformat Sections: 12 60 00 / 12 61 00 / 12 63 00 / 13 34 16.53 / 12 64 00 / 12 65 00 / 12 66 00 / 12 67 00 / 12 68 00

[See [E2010.10](#)]

E2010.90 21-05 20 10 90 Other Fixed Furnishings

Includes: Fixed artificial plants, planters, and accessories.

Associated Masterformat Sections: 12 90 00 / 12 92 00 / 12 92 13 / 12 92 33 / 12 92 43

[See [E2010.10](#)]

E2050 21-05 20 50 Movable Furnishings

Includes: Items of moveable furniture and furnishing accessories. Includes furniture for a variety of uses including classroom, dormitory, ecclesiastical, hotel and motel, laboratory, library, lounge, medical, office, restaurant, and residential.

Associated Masterformat Sections:

[See [E2010](#)]

E2050.10 21-05 20 50 10 Movable Art

Includes: Interior and exterior moveable art objects such as paintings, and sculpture.

Associated Masterformat Sections: 12 10 00 / 12 14 00 / 12 19 00

[See [E2010.10](#)]

E2050.30 21-05 20 50 30 Furniture

Includes: Movable interior furniture.

Associated Masterformat Sections: 12 50 00 / 12 51 00 / 12 52 00 / 12 52 23 / 12 52 70 / 12 53 00 / 12 54 00 / 12 54 13 / 12 54 16 / 12 55 00 / 12 56 00 / 12 56 33 / 12 56 39 / 12 56 43 / 12 56 51 / 12 56 52 / 12 56 53 / 12 56 70 / 12 57 00 / 12 57 13 / 12 57 16 / 12 58 00 / 12 59 00

[See [E2010.10](#)]

E2050.40 21-05 20 50 40 Accessories

Includes: Interior furnishing accessories not attached to permanent construction.

Associated Masterformat Sections: 12 40 00 / 12 41 00 / 12 42 00 / 12 43 00 / 12 44 00 / 12 44 16 / 12 45 00 / 12 46 00 / 12 48 00

[See [E2010.10](#)]



Uniformat Omniclass

E2050.60 21-05 20 50 60 Movable Multiple Seating

Includes: Portable seating for auditoriums, lecture halls, stadiums, arenas, gymnasiums, religious buildings, restaurants, and other facilities where multiple seating is required.

Associated Masterformat Sections: 12 60 00 / 12 62 00 / 12 65 00 / 12 67 00 / 12 68 00

[See [E2010.10](#)]

E2050.90 21-05 20 50 90 Other Movable Furnishings

Includes: Moveable artificial plants, and planters.

Associated Masterformat Sections: 12 90 00 / 12 92 00 / 12 92 13 / 12 92 33 / 12 92 43

[See [E2010.10](#)]



Unifomat Omniclass

F 21-06 00 00 SPECIAL CONSTRUCTION & DEMOLITION

Associated Masterformat Sections:

F10 21-06 10 Special Construction

Associated Masterformat Sections: 01 88 13

F1010 21-06 10 10 Integrated Construction

Associated Masterformat Sections:

[See [Fundamental LOD Definitions](#)]

F1020 21-06 10 20 Special Structures

Associated Masterformat Sections: 13 30 00 / 01 88 13

[See [Fundamental LOD Definitions](#)]

F1020.40 21-06 10 20 40 Special Structures: Metal Building Systems

Includes: Prefabricated buildings and structures assembled on temporary and permanent foundations.

Associated Masterformat Sections: 13 34 00 / 01 88 13 / 13 34 13 / 13 34 16 / 13 34 19 / 13 34 56

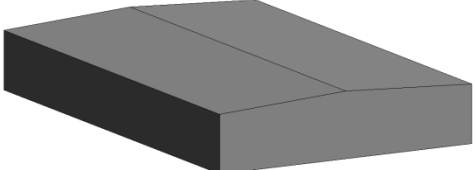
100	Generic mass of special structure with system typically noted with a design narrative for conceptual pricing.	 <p><i>193 F1020.40-LOD 100 Metal Building Systems, From lkerd.com</i></p>
-----	---	---

F1020.40.10 21-06 10 20 40 Special Structures: Metal Building Systems - Primary Framing and Bracing

Includes: Prefabricated buildings and structures assembled on temporary and permanent foundations.

Associated Masterformat Sections: 13 34 00 / 01 88 13 / 13 34 13 / 13 34 16 / 13 34 19 / 13 34 56

100	See F1020.40	
-----	--------------	--

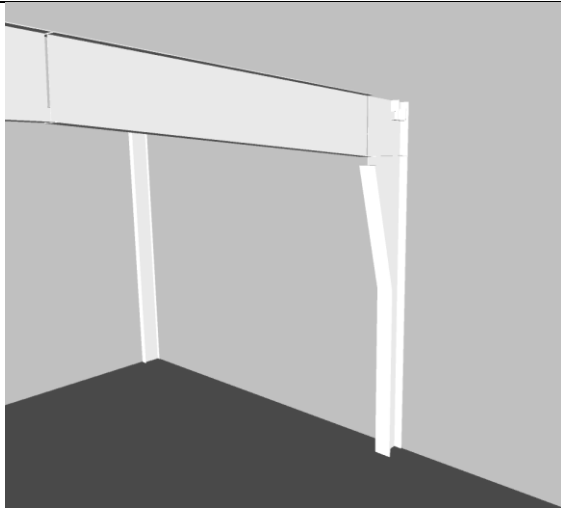
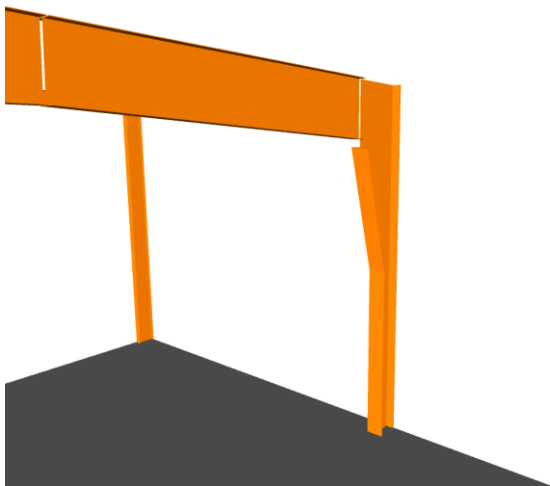

Unifomat Omniclass

200	<p>Element modeling to include:</p> <ul style="list-style-type: none">• Primary frame, approximate member size and location per defined structural grids.• Bracing, approximate member size and location.	 <p>194 F1020.40-LOD 200 Metal Building Systems - Primary Framing, From lkerd.com</p>
300	<p>Element modeling to include:</p> <ul style="list-style-type: none">• Primary frame, specific member size and location per defined structural grids.• Bracing, specific member size and location.	 <p>195 F1020.40-LOD 300 Metal Building Systems - Primary Framing, From lkerd.com</p>

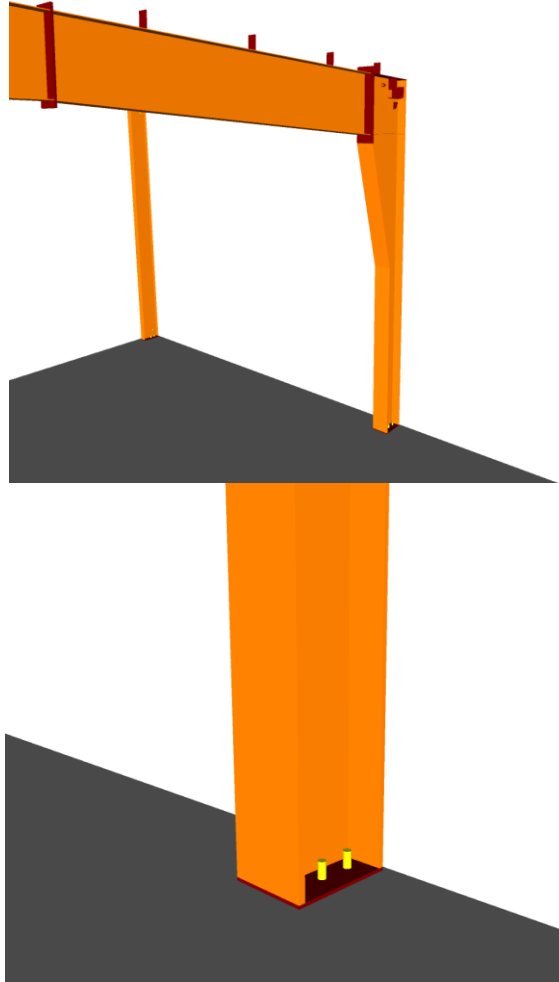

Unifomat Omniclass

350	<p>Element modeling to include:</p> <ul style="list-style-type: none">• Actual elevations and locations of connections.• Main elements of connections (bolts, plates, stiffeners, etc.).• Any miscellaneous steel (mill secondary framing, equipment supports, etc.).	 <p>196 F1020.40-LOD 350 Metal Building Systems - Primary Framing, From lkerd.com</p>
-----	---	---

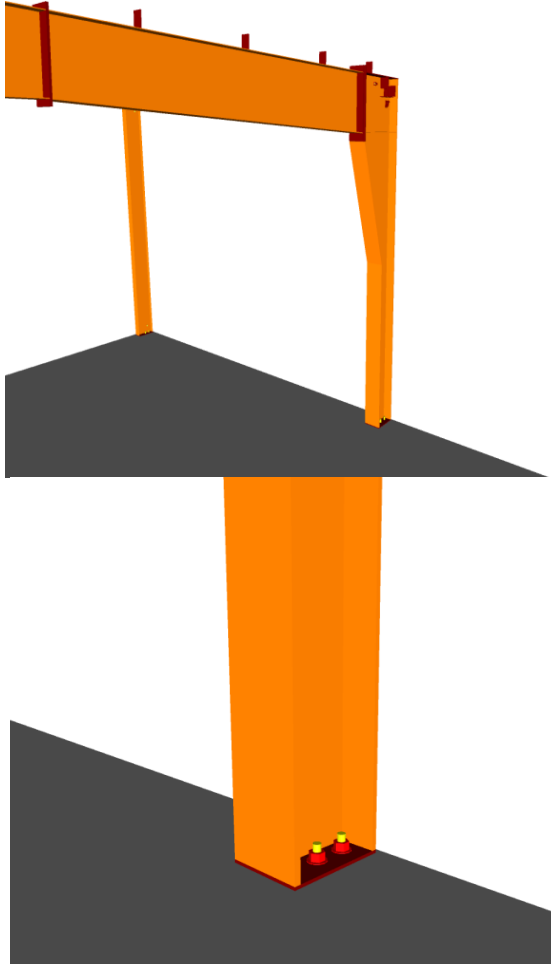

Unifomat Omniclass

<p>400</p>	<p>Element modeling to include :</p> <ul style="list-style-type: none"> • Welds • Reinforcement plates • Coping of members • Bolts, nuts, washers, etc. • Holes, slots, etc., including holes for future element attachments • All assembly elements 	 <p>197 F1020.40-LOD 400 Metal Building Systems - Primary Framing, From lkerd.com</p>
------------	--	---

F1020.40.20 21-06 10 20 40 **Special Structures: Metal Building Systems - Secondary Framing**

Includes: Prefabricated buildings and structures assembled on temporary and permanent foundations.

Associated Masterformat Sections: 13 34 00 / 01 88 13 / 13 34 13 / 13 34 16 / 13 34 19 / 13 34 56

<p>100</p>	<p>See F1020.40</p>	
------------	---------------------	--

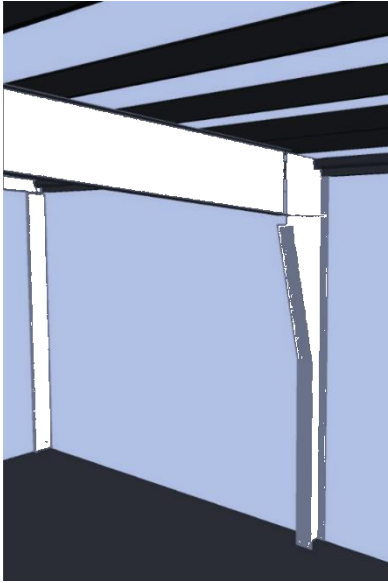
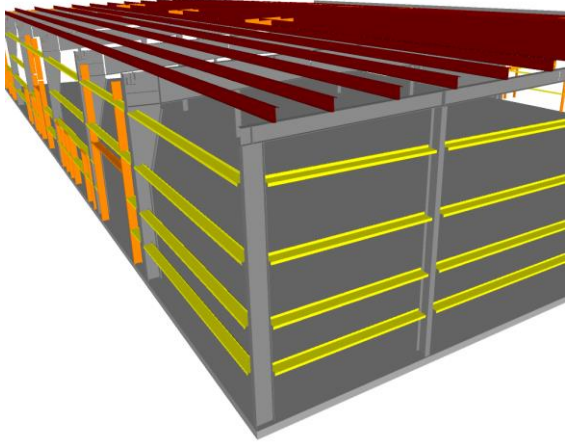

Unifomat Omniclass

200	<p>Generic mass of special structure with system typically noted with a design narrative for conceptual pricing. Generic open wall conditions identified (i.e., open for material by others, open for passage, etc.)</p> <p>Approximate overall depth and extent represented by secondary roof and wall framing members.</p>	 <p>198 F1020.40-LOD 200 Metal Building Systems - Secondary Framing, From lkerd.com</p>
300	<p>Element modeling to include:</p> <ul style="list-style-type: none">• Secondary roof and wall framing members, specific size and location (spacing and elevations).• Overall depth and end seat depth for open web members.	 <p>199 F1020.40-LOD 300 Metal Building Systems - Secondary Framing, From lkerd.com</p>

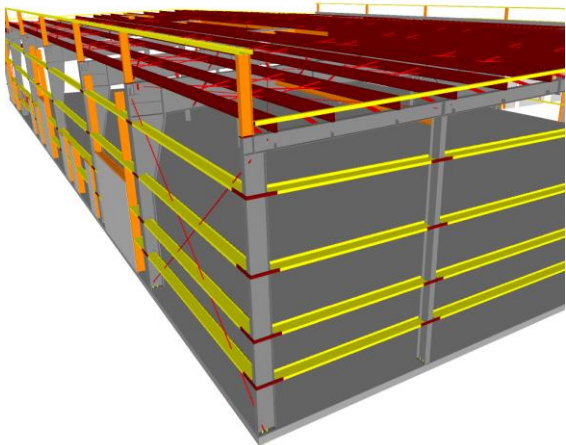
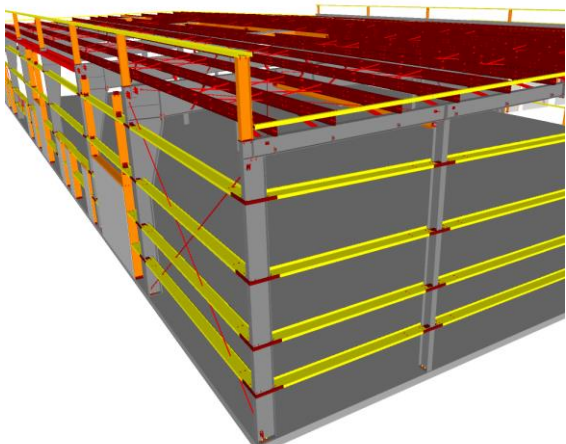

Unifomat Omniclass

<p>350</p>	<p>Element modeling to include:</p> <ul style="list-style-type: none"> • Nested members • Connections for member bracing • Clips joining secondary framing members • Large elements of typical connections applied to all secondary steel connections such as girt to column, purlin to rafter, jamb to girt, header to jamb, etc. • Secondary angles, including sheeting angles and rake angles • Base attachment members • Any miscellaneous secondary steel members with correct orientation, i.e. canopies, parapets, door framing, etc. • For open web members, see B1010.10.60 	 <p>200 F1020.40-LOD 350 Metal Building Systems-Secondary Framing , From lkerd.com</p>
<p>400</p>	<p>Element modeling to include:</p> <ul style="list-style-type: none"> • Welds • Bolts, nuts, washers, screws, and fasteners • Coping of members • Holes cut for bracing • Nested member attachments • All assembly elements • For open web members, see B1010.10.60 	 <p>201 F1020.40-LOD 400 Metal Building Systems - Secondary Framing , From lkerd.com</p>

F1020.40.30 21-06 10 20 40 Special Structures: Metal Building Systems - Cladding and Exterior Trim

Includes: Prefabricated buildings and structures assembled on temporary and permanent foundations.

Associated Masterformat Sections: 13 34 00 / 01 88 13 / 13 34 13 / 13 34 16 / 13 34 19 / 13 34 56

<p>100</p>	<p>See F1020.40</p>	
------------	---------------------	--

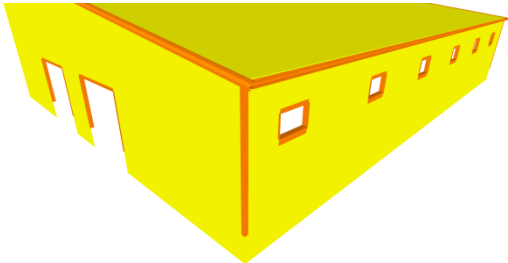
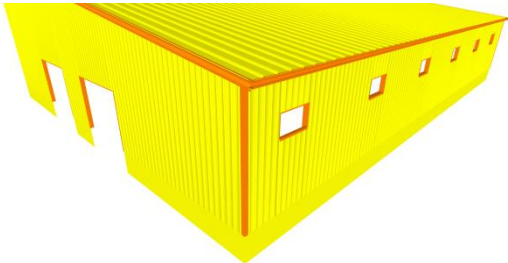

Unifomat Omniclass

<p>200</p>	<p>Element modeling to include:</p> <ol style="list-style-type: none"> 1) Panel: <ol style="list-style-type: none"> a. Generic mass of panel with a generic profile or graphical texture shown. b. Openings/Voids locations are represented but remain flexible. 2) Trim: <ol style="list-style-type: none"> a. Generic trim profile represented by a single assembly. 	 <p><i>202 F1020.40-LOD 200 Metal Building Systems – Cladding and Exterior Trim, From lkerd.com</i></p>
<p>300</p>	<p>Element modeling to include:</p> <ul style="list-style-type: none"> • Panel: <ul style="list-style-type: none"> ○ Panel with actual profile or graphical texture shown, filling the boundary set by the plane object. ○ Significant accessories provided by metal building manufacturer (i.e., light transmitting panels, ridge vents, curbs). ○ Shop-located openings/Voids are represented in true dimensions/locations. • Trim: <ul style="list-style-type: none"> ○ Major trims (primary exterior pieces) are shown, represented by the assumed trim profile and thickness. <ul style="list-style-type: none"> ▪ Gutters ▪ Corner boxes ▪ Corner trim ▪ Open wall trim ▪ Framed opening trim 	 <p><i>203 F1020.40-LOD 300 Metal Building Systems – Cladding and Exterior Trim, From lkerd.com</i></p>

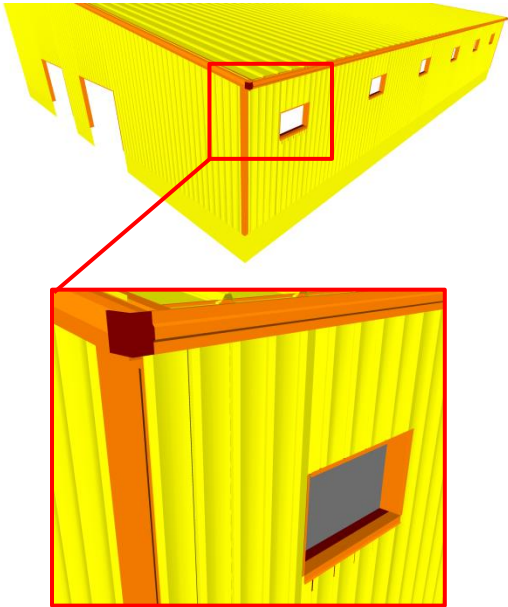

Unifomat Omniclass

<p>350</p>	<p>Element modeling to include:</p> <ul style="list-style-type: none">• Panel:<ul style="list-style-type: none">○ Actual profile modeled filling the boundary set by the plane object.○ Closures○ Downspouts• Trim:<ul style="list-style-type: none">○ Minor trims (end caps, transition pieces, etc.) are shown, represented by the assumed trim profile and thickness. <p>Other non-graphic information may be included such as: Textual information on installation details</p>	 <p><i>204 F1020.40-LOD 350 Metal Building Systems – Cladding and Exterior Trim, From lkerd.com</i></p> <p><i>F1020.40-LOD 350 Metal Building Systems – Cladding and Exterior Trim, From lkerd.com</i></p>
------------	---	--



Uniformat Omniclass

400	<p>Element modeling to include fabrication level information:</p> <ul style="list-style-type: none">• Panel:<ul style="list-style-type: none">○ Individual panel objects, with actual profile shown, positioned accurately within the building plane boundary and shown at installed length.○ Fasteners at critical locations○ Closures○ Cinch straps○ Caulk/mastic and other field-installed weather-tightness materials shown at critical locations• Trim:<ul style="list-style-type: none">○ Minor trims (end caps, transition pieces, etc.) are shown accurately.○ Attachment or accessories (fasteners, etc.) shown at critical locations.○ Caulk/mastic and other field-installed weather-tightness materials shown at critical locations <p>Other non-graphic information may be included such as: Additional material and its installation instructions required for proper installation Mark identification that correlates with bill of material (i.e., piece mark) Fastener material and installation instructions Caulk/mastic and other field-installed weather-tightness materials and installation instructions</p>	
-----	---	--

F1030 21-06 10 30
[See [Fundamental LOD Definitions](#)]

Special Function Construction

F1050 21-06 10 50
[See [Fundamental LOD Definitions](#)]

Special Facility Components

F1060 21-06 10 60

Athletic and Recreational Special Construction

Includes: Special construction for athletic and recreational activities that are directly related to the adjacent construction.

Associated Masterformat Sections: 13 28 00

[See [Fundamental LOD Definitions](#)]



Unifomat Omniclass

F1080 21-06 10 80 Special Instrumentation

Includes: Instrumentation for measuring and recording phenomena such as stresses in structures, solar and wind energy, and effects of earthquakes.

Associated Masterformat Sections: 13 50 00

[See [Fundamental LOD Definitions](#)]

F20 21-06 20 Facility Remediation

Associated Masterformat Sections:

F2010 21-06 20 10 Hazardous Materials Remediation

Includes: Remediation for abatement and removal and disposal of contaminated materials within structures.

Associated Masterformat Sections: 02 80 00

[See [Fundamental LOD Definitions](#)]

F30 21-06 30 Demolition

Associated Masterformat Sections:

F3010 21-06 30 10 Structure Demolition

Includes: Complete removal and disposal of structures.

Associated Masterformat Sections: 02 41 16

[See [Fundamental LOD Definitions](#)]

F3030 21-06 30 30 Selective Demolition

Includes: Removal and disposal of parts of structures.

Associated Masterformat Sections: 02 41 19

[See [Fundamental LOD Definitions](#)]

F3050 21-06 30 50 Structure Moving

Includes: Preparation and processes of relocating and raising structures.

Associated Masterformat Sections: 02 43 00

[See [Fundamental LOD Definitions](#)]

G 21-07 00 00 BUILDING SITEWORK

Associated Masterformat Sections: 01 89 00

G10 21-07 10 Site Preparation

Associated Masterformat Sections: 01 89 13

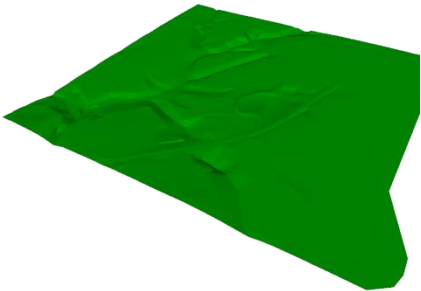

Unifomat Omniclass

100	A simple topographic surface is provided.	 <p data-bbox="1068 646 1515 699">205 G10-LOD-100 Site Preparation, From lkerd.com</p>
200	<p>Element modeling to include:</p> <ul style="list-style-type: none"> • Approximate size and shape of foundation element • Approximate size/location of utilities and structures • Approximate code and clearance requirements • Approximate pipe material • Rough modeling of site grading 	

G1010 21-07 10 10 Site Clearing

Includes: Removal of vegetation from the site, including stripping of sod and soil, and tree pruning for site clearing.

Associated Masterformat Sections: 31 10 00 / 31 11 00 / 31 13 00 / 31 14 00 / 31 14 13 / 31 14 16

G1020 21-07 10 20 Site Elements Demolition

Includes: Removal of above and below grade site improvements.

Associated Masterformat Sections: 02 41 13

G1030 21-07 10 30 Site Element Relocations

Includes: Relocation of utility systems.

G1050 21-07 10 50 Site Remediation

Includes: Remediation of contaminated sites.

Associated Masterformat Sections: 02 50 00 / 01 89

G1070 21-07 10 70 Site Earthwork

Includes: Moving earth to establish new contours and elevations.

Associated Masterformat Sections: 31 20 00 / 01 89 13



Unifomat Omniclass

G1070.10 21-07 10 70 10 Grading

Includes: Earthmoving to reshape contours.

Associated Masterformat Sections: 31 20 00 / 01 89 13

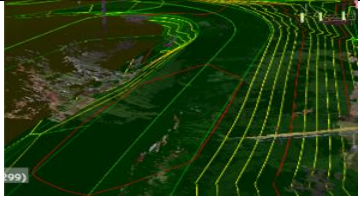
100	Proposed Surfaces shown as a plane.	 <p>, From lkerd.com</p>
200	Proposed Surface: Generic Surface Interpolation between the following elements: Building Envelope at Finish Floor, Finish Grade at Retaining Walls, Grading Limits. Curbs, hardscape, finish surface at building envelopes.	
300	Proposed Surface: Complete and accurate surface definition based on defined fine grading, grade breaks, curbs, hardscape, buildings, swales, etc. Local Coordinate Control. Shared Coordinate from Building Grid base point to real-world project control	
350	Include existing Surface: 3D surface generated from site topography, with grade breaks and lines as needed to define accurate surface. 3D site features included if provided by surveyor (i.e. walls, signage, stairs, etc., as defined in Survey LOC-Grade). Added definition from supplemental survey, revised limits of work	
400	Surface modeled to facilitate robotic controlled grading and GPS grade-control systems.	 <p>, From lkerd.com</p>

G20 21-07 20 Site Improvements

Associated Masterformat Sections: 01 89 16

100	Diagrammatic or schematic model elements.	
-----	---	--



Uniformat Omniclass

200	Element modeling to include: <ul style="list-style-type: none"> • Approximate size and shape of foundation element • Approximate size/location of utilities and structures • Approximate code and clearance requirements • Rough modeling of site grading 	
-----	---	--

G2010 21-07 20 10 Roadways

Includes: Pavement, curbs and gutters, appurtenances, lighting, and vehicle fare collection for roadways. May Include: Site earthwork.

Associated Masterformat Sections: 01 89 16

[See [Fundamental LOD Definitions](#)]

G2020 21-07 20 20 Parking Lots

Includes: Pavement, curbs and gutters, appurtenances, lighting, and parking control equipment for parking lots. May Include: Site earthwork

Associated Masterformat Sections: 01 89 16

[See [Fundamental LOD Definitions](#)]

G2020.10 21-07 20 20 10 Parking Lot Pavement

Includes: Prepared and compacted soil and granular layers placed prior to installation of parking lot pavement. Includes: Finished parking lot pavement of granular and asphaltic materials. Includes: Finished parking lot pavement with high bending resistance, usually of concrete. Includes: Blocks or tiles used for parking lot pavement. Unit pavers set in mastic, sand, or mortar.

Associated Masterformat Sections: 32 10 00 / 32 12 00 / 32 13 00 / 32 14 00 / 32 15 00

100	See G20	
200	See G20	
300	Specific thickness of pavement and substrate modeled. All drainage slopes modeled.	
350	Openings for drains and other services modeled.	

G2020.20 21-07 20 20 20 Parking Lot Curbs and Gutters

Includes: Construction at perimeter of parking lot pavement to separate pavement from adjacent surfaces, provide vehicular restraint, and facilitate drainage.

Associated Masterformat Sections: 32 16 13

100	See G20	
200	See G20	
300	Full extents of curbs and gutters (above and below grade) are modeled.	
350	Element modeling to include: <ul style="list-style-type: none"> • Reinforcing • Pour stops • Expansion joints 	



Unifomat Omniclass

G2020.40 21-07 20 20 40 Parking Lot Appurtenances

Includes traffic signals, signage, striping.

Associated Masterformat Sections: 32 17 00 / 32 17 13 / 32 17 43 / 10 14 53 / 32 17 23

G2030 21-07 20 30 Pedestrian Plazas and Walkways

Includes: Pavement, curbs and gutters, appurtenances, lighting, and pedestrian control equipment for pedestrian plazas and walkways. Includes exterior steps and ramps. May Include: Site earthwork.

Associated Masterformat Sections: 01 89 16

For Steps & Stairs refer to B1080 / 21-02 10 80 Stairs

For Ramps refer to B1010.50 / 21-02 10 10 50 Ramps

For Pedestrian control equipment and other street or exterior furniture refer to E2010 / 21-05 20 10 Fixed Furnishings

For Handrails refer to C1090.10 / 21-03 10 90 10 Interior Railings and Handrails

For Lighting refer to G4050 / 21-07 40 50 Site Lighting

For Site Earthwork and Grading refer to G1070 / 21-07 10 70 10 Grading

For Drainage refer to G3030 / 21-07-30-30

100	See G20	
200	See G20	
300	<p>Element modeling to include:</p> <ul style="list-style-type: none"> • Overall size and geometry of all elements • Locations of ramps & landings • Crossfalls & drainage slopes • Overall material • Pavement thickness 	
350	<p>Element modeling to include:</p> <ul style="list-style-type: none"> • Expansion joints • Path intersections • Kerb ramps 	
400	<p>Element modeling to include:</p> <ul style="list-style-type: none"> • Subsurface structure including thickness, material,... • All joints • Accurate materials and finishes (colored concrete,...) 	



Unifomat Omniclass

	• Tactiles	
--	------------	--

G2040 21-07 20 40 Airfields

Includes: Pavement, curbs and gutters, appurtenances, lighting, and airfield signally and control equipment for airfields. May Include: Site earthwork.

Associated Masterformat Sections: 01 89 16

G2050 21-07 20 50 Athletic, Recreational, and Playfield Areas

Includes: Surfacing, fencing, equipment, grandstands and bleachers, and lighting for athletic, recreational, and playfield areas. May Include: Site earthwork.

Associated Masterformat Sections: 01 89 16

For Equipment and Play Structures, refer to sections 21-01 Substructure & 21-02 Shell.

For Lighting refer to section 21-07 40 50 Site Lighting

For Site Earthwork and Grading refer to Section 21-07 10 70 10 Grading

For Drainage refer to Section 21-07-30-30

100	See G20	
200	See G20	
300	Element modeling to include: <ul style="list-style-type: none"> • Overall size and geometry of all elements • Crossfalls & drainage slopes 	
350	Element modeling to include: <ul style="list-style-type: none"> • Fences detailed geometry including footings • Fall zones • Materials 	
400	Element modeling to include: <ul style="list-style-type: none"> • Subsurface structure including thickness, material,... • Linemarking • Accurate materials and finishes (colored concrete,...) 	



Unifomat Omniclass

G2060 **21-07 20 60** **Site Development**
[See [Fundamental LOD Definitions](#)]

G2080 **21-07 20 80** **Landscaping**
Includes: Trees, grass, and planting

Associated Masterformat Sections: 31 20 00 / 01 89 13

100	See G20	
200	<ul style="list-style-type: none"> • Extent of the grass and planting area in 3D as a flat mesh or lines • Approximate location of existing trees • Trees to be removed and retain • Approximate location of proposed trees • Local coordinate system is defined and related to other consultants coordinate system (MGA,...) 	
300	<p>Model to include :</p> <ul style="list-style-type: none"> • Extent of the grass and planting areas draped on the grading surface. • Accurate location and size of existing trees from feature survey or arborist report (2D or 3D) • Trees to be removed and retain • Accurate location of proposed trees included in the grading model <p>Tree species</p> <ul style="list-style-type: none"> • Tree protection zone for existing trees (2D) 	
350	<p>Model to include :</p> <ul style="list-style-type: none"> • Topsoil thickness • Separation between planting and grass species • Space requirements for root systems modelled as massing element • Canopy size and mature size. 	

G30 **21-07 30** **Liquid and Gas Site Utilities**
Associated Masterformat Sections: 01 89 19



Unifomat Omniclass

100	Narrative that references the grading model	
200	Approximate sizes, vertical control, and apparatus.	

G3010 21-07 30 10 Water Utilities

Includes: Water distribution for domestic consumption, fire fighting, and irrigation for a facility site and for multiple facilities. Includes trenching and backfilling. Includes Liquid and Gas Site Utilities Supplementary Components as appropriate.

Associated Masterformat Sections: 33 10 00

100	See G30	
200	See G30	

G3010.10 21-07 30 10 10 Site Domestic Water Distribution

Includes: Supply wells, piping, equipment, storage tanks, and water ponds and reservoirs.

Associated Masterformat Sections: 01 89 19 / 33 21 00 / 33 11 00 / 33 12 00 / 33 12 13 / 33 12 16 / 33 12 19 / 33 12 23 / 33 12 33 / 33 13 00 / 33 16 00 / 33 47 19.13 / 33 47 13.13 / 33 47 16.13

100	See G30	
200	See G30	

G3010.30 21-07 30 10 30 Site Fire Protection Water Distribution

Includes: Supply wells, piping, equipment, storage tanks, and water ponds and reservoirs.

Associated Masterformat Sections: 01 89 19 / 33 21 00 / 33 11 19 / 33 12 00 / 33 12 13 / 33 12 16 / 33 12 19 / 33 12 23 / 33 12 33 / 33 16 00 / 33 47 19.33 / 33 47 13.13 / 33 47 16.13

100	See G30	
200	See G30	

G3020 21-07 30 20 Sanitary Sewerage Utilities

Includes: Sanitary sewerage for a facility site and for multiple facilities. Includes piping, septic tanks that serve multiple facilities, structures, and lagoons. Includes trenching and backfilling. Includes Liquid and Gas Site Utilities Supplementary Components as appropriate.

Associated Masterformat Sections: 33 30 00 / 01 89 19

100	See G30	
200	See G30	



Unifomat Omniclass

G3020.20 21-07 30 20 20 Sanitary Sewerage Piping

Associated Masterformat Sections: 33 31 00 / 33 33 00 / 33 34 00

100	See G30	
200	See G30	
300	Specific elevations, sizes, materials	

G3020.50 21-07 30 20 50 Sanitary Sewerage Structures

Associated Masterformat Sections: 33 39 00 / 33 39 13 / 33 39 23

100	See G30	
200	Approximate structure types, sizes and materials	
300	Specific structure elements at all locations, specific sizes and materials	

G3030 21-07 30 30 Storm Drainage Utilities

Includes: Storm drainage for surface or combination of surface and subsurface water for a facility site or for multiple facilities. Includes piping, culverts, water drains, drainage pumps, Subdrainage, and storm drainage ponds and reservoirs. Includes trenching and backfilling. Includes Liquid and Gas Site Utilities Supplementary Components as appropriate.

Associated Masterformat Sections: 01 89 19

100	See G30	
200	See G30	

G3050 21-07 30 50 Site Energy Distribution

Includes: Energy distribution for a facility site or multiple facilities. Includes hydronic heating, steam energy, and hydronic cooling distribution. Includes trenching and backfilling. Includes Liquid and Gas Site Utilities Supplementary Components as appropriate.

100	See G30	
200	See G30	

G3060 21-07 30 60 Site Fuel Distribution

Includes: Gas, fuel-oil, gasoline, diesel fuel, and aviation fuel distribution for a facility site or multiple facilities. Includes trenching and backfilling. Includes Liquid and Gas Site Utilities Supplementary Components as appropriate.

100	See G30	
200	See G30	



Uniformat Omniclass

G3090 21-07 30 90 Liquid and Gas Site Utilities Supplementary Components

Includes: Common work results for utilities and instrumentation and control to be included in liquid and gas utility elements above as appropriate.

These components are typically modeled as part of other assemblies listed in the tables above. Do not assign this Uniformat classification unless a supplementary component is modeled independently of another assembly.

G40 21-07 40 Electrical Site Improvements

Associated Masterformat Sections: 01 89 26

100	Diagrammatic or schematic model elements: conceptual and/or schematic layout; design performance parameters as defined in the BXP to be associated with model elements as non-graphic information.	
-----	--	--

G4010 21-07 40 10 Site Electric Distribution Systems

Description: Electrical wiring systems to distribute electrical power to on the Site. Includes Duct Banks, Pullboxes, vaults and transformers from the utility point of connection, to the building's main electric room.

Associated Masterformat Sections: 01 89 26

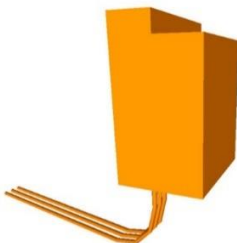
100	See G40	
200	Generic model elements in schematic layout with: approximate size, shape, and location of equipment; approximate access/code clearance requirements modeled; design performance parameters as defined in the BXP to be associated with model elements as non-graphic information.	
300	Modeled as design-specified size, shape, spacing, and location of raceways/ boxes/enclosures/duct banks in the power distribution system specified size, shape, spacing, and location of equipment and associated components; approximate allowances for spacing and clearances required for all specified hangers, supports and seismic control access/code clearance requirements modeled	 <p>206 G4010-LOD-300 Site Electric Distribution Systems, From lkerd.com</p>

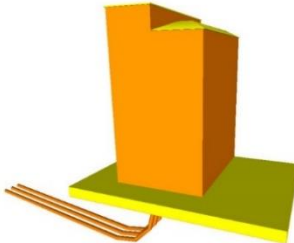
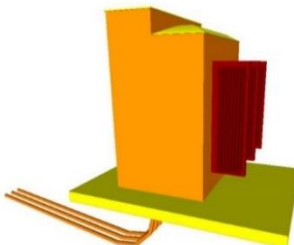

Unifomat Omniclass

<p>350</p>	<p>Modeled as actual size, shape, spacing, and location of raceways/ boxes/enclosures/duct banks in the power distribution system;</p> <p>actual size, shape, spacing, and location for supports and seismic control;</p> <p>actual size, shape, and location/connections of equipment and support structure/pads.</p> <p>Actual access/code clearance requirements modeled</p>	 <p>207 G4010-LOD-350 Site Electric Distribution Systems, From lkerd.com</p>
<p>400</p>	<p>Supplementary components added to the model required for fabrication and field installation.</p>	 <p>208 G4010-LOD-400 Site Electric Distribution Systems, From lkerd.com</p>

G4050 21-07 40 50 Site Lighting

Description: Luminaires, lighting equipment, ballasts, and accessories. Includes fluorescent, high intensity discharge, incandescent, mercury vapor, neon, and sodium vapor lighting. Includes Pole Mount, Building Mount and on-grade fixtures for exterior lighting.
Associated Masterformat Sections: 26 56 29

<p>100</p>	<p>See G40</p>	
<p>200</p>	<p>Generic elements in schematic layout with:</p> <p>approximate size, shape, and location of equipment;</p> <p>approximate access/code clearance requirements modeled;</p> <p>design performance parameters as defined in the BXP to be associated with model elements as non-graphic information.</p>	
<p>300</p>	<p>Modeled as design-specified size, shape, spacing, and location of lighting fixtures;</p> <p>approximate allowances for spacing and clearances required for all specified hangers, supports and seismic control;</p> <p>required pole bases and footing elements;</p> <p>access/code clearance requirements modeled.</p>	



Unifomat Omniclass

350	<p>Modeled as actual size, shape, spacing, and location of lighting fixtures;</p> <p>actual size, shape, spacing, and location for supports and seismic control;</p> <p>actual size, shape, and location/connections of equipment and support structure/pads.</p> <p>Actual access/code clearance requirements modeled.</p>	
400	<p>Supplementary components added to the model required for fabrication and field installation.</p>	

G50 21-07 50 Site Communications

100	<p>Diagrammatic or schematic model elements:</p> <p>conceptual and/or schematic layout;</p> <p>design performance parameters as defined in the BXP to be associated with model elements as non-graphic information.</p>	
-----	---	--

G5010 – Site Communications Systems

Description: Conduit Systems for routing of Communication trunk systems.

Associated Masterformat Sections: 33 80 00

100	<p>See G50</p>	
200	<p>Generic elements in a schematic layout with:</p> <p>approximate size, shape, and location of equipment;</p> <p>approximate access/code clearance requirements modeled;</p> <p>design performance parameters as defined in the BXP to be associated with model elements as non-graphic information.</p>	
300	<p>Modeled as design-specified size, shape, spacing, and location of raceways, boxes, and enclosures in the power distribution system;</p> <p>size, shape, spacing, and location of equipment and associated components;</p> <p>approximate allowances for spacing and clearances required for all specified hangers, supports and seismic control;</p> <p>access/code clearance requirements modeled.</p>	



Unifomat Omniclass

350	Modeled as actual size, shape, spacing, and location of raceways, boxes, and enclosures in the power distribution system; size, shape, spacing, and location for supports and seismic control; size, shape, location, and connections of equipment and support structure or pads; floor and wall penetration elements are modeled. Actual access/code clearance requirements modeled.	
400	Supplementary components added to the model required for fabrication and field installation.	

G90

21-07 90

Miscellaneous Site Construction

Associated Masterformat Sections: 01 89 29

G9010

21-07 90 10

Tunnels

Includes: Vehicular, pedestrian, and service tunnels. Includes tunnel boring, bracing and jacking work, linings and casing, grouting support systems, boring machines, and control and spoil removal systems. Includes Tunnel Construction Related Activities as appropriate.

Associated Masterformat Sections: 31 70 00 / 01 89 29

[See [Fundamental LOD Definitions](#)]



Unifomat Omniclass

N/A 22-31 23 16 13 Trenches

Includes: Element shape representing the area required of removed earth for subterranean installation and any additional elements required for installation.

Associated Masterformat Sections: 31 06 20.13 / 31 23 16.13 / 31 23 33 / 31 35 26.23 / 31 41 33 / 31 77 13 / 33 05 07.53

100	Assumptions for trenches are included in other modeled elements such as foundations, civil piping and duct banks, etc	
200	Assumptions for trenches are included in other modeled elements such as foundations, civil piping and duct banks, etc	
300	<p>Elements are modeled to represent the required size and shape for temporary trenching to accommodate the installation of model elements.</p> <p>Element modeling to include:</p> <ul style="list-style-type: none"> • Overall size and geometry of the trench • Sloping surfaces 	
350	<p>Element modeling to include:</p> <ul style="list-style-type: none"> • Thrust block or underground reinforcements. 	
400		



Unifomat Omniclass

N/A 23-13 STRUCTURAL AND EXTERIOR ENCLOSURE PRODUCTS

N/A 23-13-23 Mechanical Fasteners, Adhesives, and Sealants

N/A 23-13 23 11 Mechanical Fasteners – L-Bolt

Includes: Cast-in anchors per American Concrete Institute 318 building code.

Associated Masterformat Sections: N/A

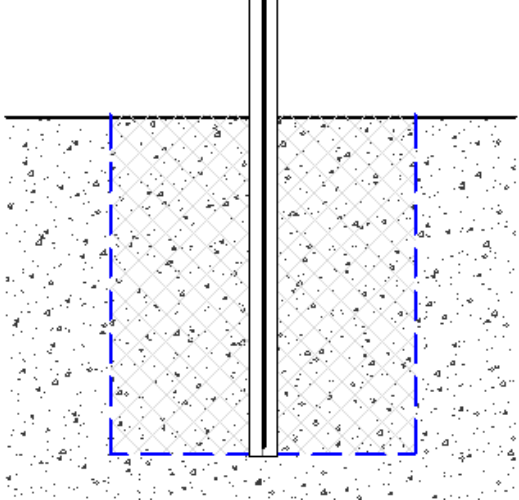
200	Refer to the model element of the main assembly being connected.	N/A
300	Refer to the model element of the main assembly being connected.	N/A
350	<p>Element modeling to include:</p> <ul style="list-style-type: none"> • Anchor Length • Embedment Length • Projection Length • Edge Distance Zone • Spacing Zone • Geometry, base size without threads <p>Required non-graphic information associated with model elements to include:</p> <ul style="list-style-type: none"> • Anchor materials defined • Anchor type defined • Base material type (steel, concrete, masonry, etc) • Base material strength • Base material condition (New, existing, cracked, uncracked, saturated, etc.) • Finishes, i.e. primed, galvanized, etc. 	 <p>LOD 350 L-Bolt Anchor, From AscendBKF.org</p>

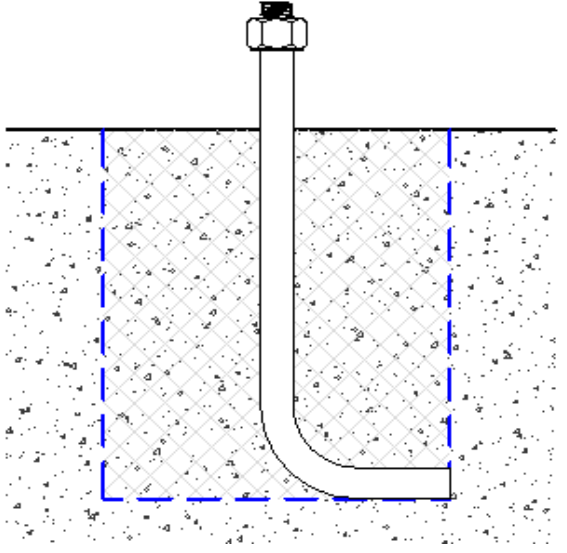

Unifomat Omniclass

400	<p>Element modeling to include fabrication level information:</p> <ul style="list-style-type: none">• Anchor Threads• Anchor Washers• Anchor Nuts <p>Other non-graphic information may be included such as:</p> <ul style="list-style-type: none">• Mark identification that correlates with bill of material (i.e., piece mark)• Member finish (primer, galvanized, etc.)• Fastener finish (i.e., black, zinc electroplated, hot-dipped galvanized)	 <p><i>LOD 400 L-Bolt Anchor, From AscendBKF.org</i></p>
-----	--	---



Unifomat Omniclass

N/A 23-13 23 11 Mechanical Fasteners – J-Bolt

Includes: Cast-in anchors per American Concrete Institute 318 building code.

Associated Masterformat Sections: N/A

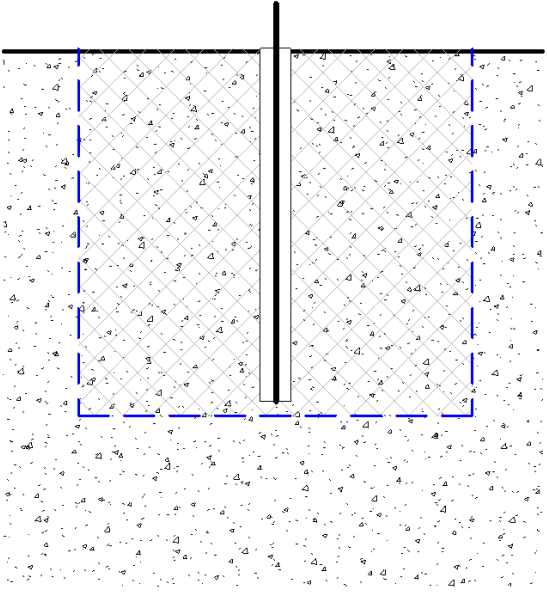
200	Refer to the model element of the main assembly being connected.	N/A
300	Refer to the model element of the main assembly being connected.	N/A
350	<p>Element modeling to include:</p> <ul style="list-style-type: none"> • Anchor Length • Embedment Length • Projection Length • Edge Distance Zone • Spacing Zone • Geometry, base size without threads <p>Required non-graphic information associated with model elements to include:</p> <ul style="list-style-type: none"> • Anchor materials defined • Anchor type defined • Base material type (steel, concrete, masonry, etc) • Base material strength • Base material condition (New, existing, cracked, uncracked, saturated, etc.) • Finishes, i.e. primed, galvanized, etc. 	 <p>LOD 350 J-Bolt Anchor, From AscendBKF.org</p>

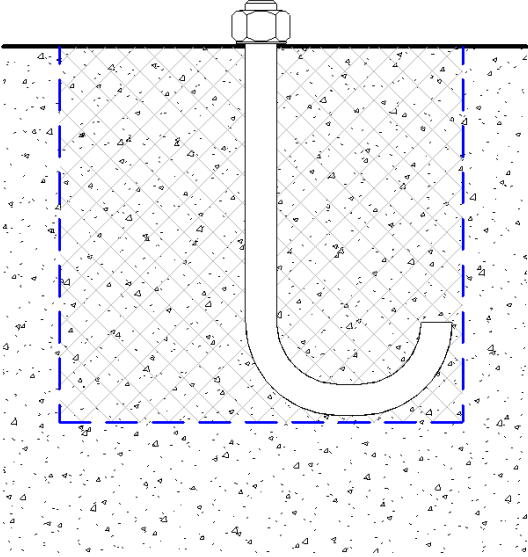

Unifomat Omniclass

<p>400</p>	<p>Element modeling to include fabrication level information:</p> <ul style="list-style-type: none"> • Anchor Threads • Anchor Washers • Anchor Nuts <p>Other non-graphic information may be included such as:</p> <ul style="list-style-type: none"> • Mark identification that correlates with bill of material (i.e., piece mark) • Member finish (primer, galvanized, etc.) • Fastener finish (i.e., black, zinc electroplated, hot-dipped galvanized) 	 <p><i>LOD 400 J-Bolt Anchor, From AscendBKF.org</i></p>
------------	--	---

N/A 23-13 23 11 Mechanical Fasteners – Hex Head Bolt with Washer

Includes: Cast-in anchors per American Concrete Institute 318 building code.

Associated Masterformat Sections: N/A

<p>200</p>	<p>Refer to the model element of the main assembly being connected.</p>	<p>N/A</p>
<p>300</p>	<p>Refer to the model element of the main assembly being connected.</p>	<p>N/A</p>

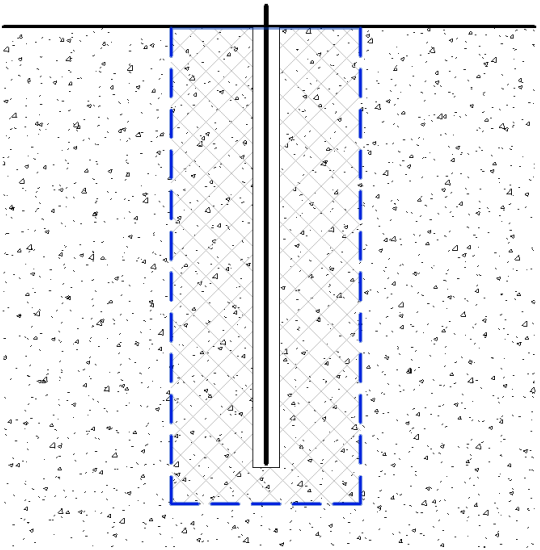
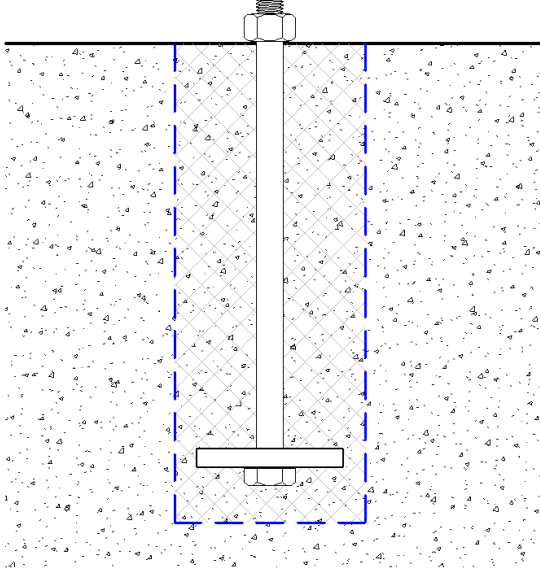

Unifomat Omniclass

<p>350</p>	<p>Element modeling to include:</p> <ul style="list-style-type: none"> • Anchor Length • Embedment Length • Projection Length • Edge Distance Zone • Spacing Zone • Geometry, base size without threads <p>Required non-graphic information associated with model elements to include:</p> <ul style="list-style-type: none"> • Anchor materials defined • Anchor type defined • Base material type (steel, concrete, masonry, etc) • Base material strength • Base material condition (New, existing, cracked, uncracked, saturated, etc.) • Finishes, i.e. primed, galvanized, etc. 	 <p><i>LOD 350 Hex Head Bolt with Washer, From AscendBKF.org</i></p>
<p>400</p>	<p>Element modeling to include fabrication level information:</p> <ul style="list-style-type: none"> • Anchor Threads • Anchor Washers • Anchor Nuts <p>Other non-graphic information may be included such as:</p> <ul style="list-style-type: none"> • Mark identification that correlates with bill of material (i.e., piece mark) • Member finish (primer, galvanized, etc.) • Fastener finish (i.e., black, zinc electroplated, hot-dipped galvanized) 	 <p><i>LOD 400 Hex Head Bolt with Washer, From AscendBKF.org</i></p>



Unifomat Omniclass

N/A 23-13 23 11 Mechanical Fasteners – Welded Headed Stud Bolt

Includes: Cast-in anchors per American Concrete Institute 318 building code.

Associated Masterformat Sections: N/A

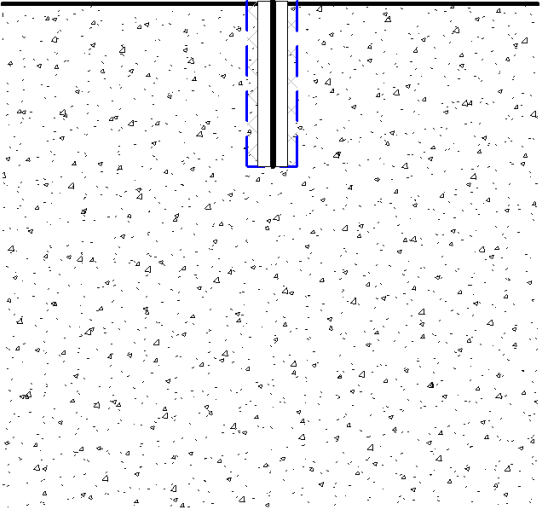
200	Refer to the model element of the main assembly being connected.	N/A
300	Refer to the model element of the main assembly being connected.	N/A
350	<p>Element modeling to include:</p> <ul style="list-style-type: none"> • Anchor Length • Embedment Length • Projection Length • Edge Distance Zone • Spacing Zone • Geometry, base size without threads <p>Required non-graphic information associated with model elements to include:</p> <ul style="list-style-type: none"> • Anchor materials defined • Anchor type defined • Base material type (steel, concrete, masonry, etc) • Base material strength • Base material condition (New, existing, cracked, uncracked, saturated, etc.) • Finishes, i.e. primed, galvanized, etc. 	 <p><i>LOD 350 Welded Headed Stud Bolt, From AscendBKF.org</i></p>

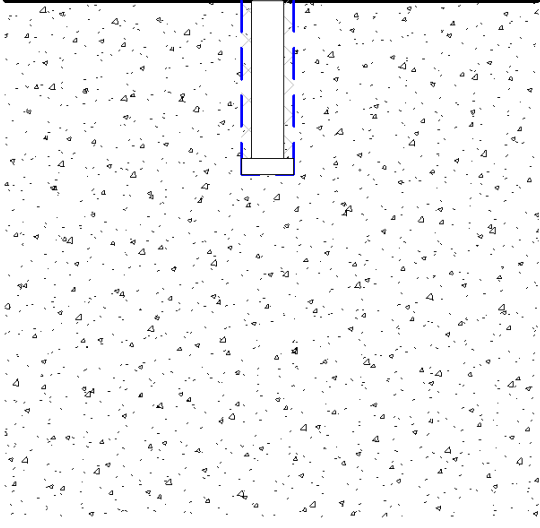

Unifomat Omniclass

400	<p>Element modeling to include fabrication level information:</p> <ul style="list-style-type: none"> • Anchor Threads • Anchor Washers • Anchor Nuts <p>Other non-graphic information may be included such as:</p> <ul style="list-style-type: none"> • Mark identification that correlates with bill of material (i.e., piece mark) • Member finish (primer, galvanized, etc.) • Fastener finish (i.e., black, zinc electroplated, hot-dipped galvanized) 	 <p><i>LOD 400 Welded Headed Stud Bolt, From AscendBKF.org</i></p>
-----	--	---

N/A 23-13 23 11 Mechanical Fasteners – Adhesive Anchor

Includes: Post-installed anchors per American Concrete Institute 318 building code.

Associated Masterformat Sections: N/A

200	Refer to the model element of the main assembly being connected.	N/A
300	Refer to the model element of the main assembly being connected.	N/A

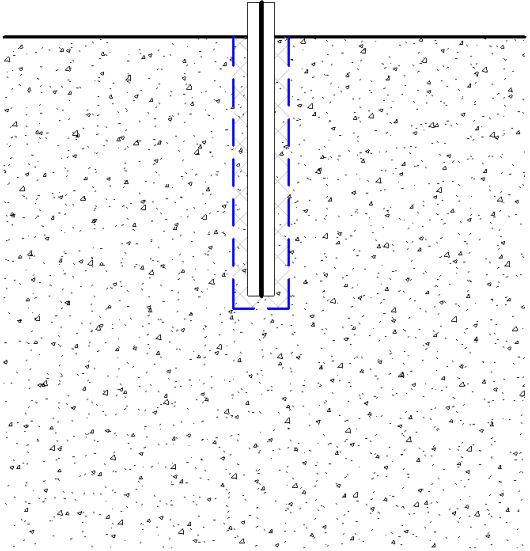
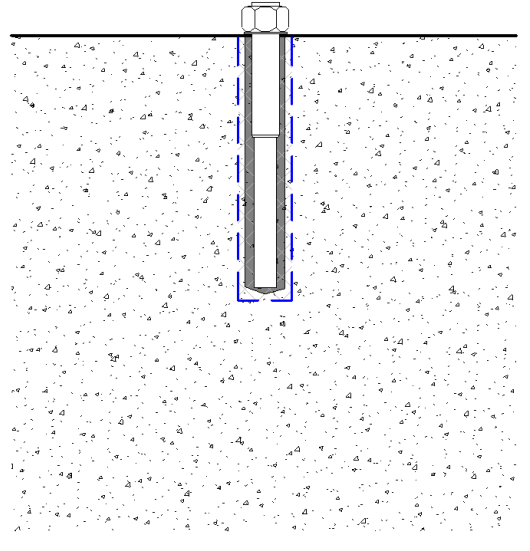

Unifomat Omniclass

<p>350</p>	<p>Element modeling to include:</p> <ul style="list-style-type: none"> • Anchor Length • Embedment Length • Projection Length • Edge Distance Zone • Spacing Zone • Geometry, base size without threads <p>Required non-graphic information associated with model elements to include:</p> <ul style="list-style-type: none"> • Anchor materials defined • Anchor type defined • Base material type (steel, concrete, masonry, etc) • Base material strength • Base material condition (New, existing, cracked, uncracked, saturated, etc.) • Finishes, i.e. primed, galvanized, etc. • Hole preparation specification 	 <p><i>LOD 350 Adhesive Anchor, From AscendBKF.org</i></p>
<p>400</p>	<p>Element modeling to include fabrication level information:</p> <ul style="list-style-type: none"> • Anchor Threads • Anchor Washers • Anchor Nuts <p>Other non-graphic information may be included such as:</p> <ul style="list-style-type: none"> • Mark identification that correlates with bill of material (i.e., piece mark) • Member finish (primer, galvanized, etc.) • Fastener finish (i.e., black, zinc electroplated, hot-dipped galvanized) 	 <p><i>LOD 400 Adhesive Anchor, From AscendBKF.org</i></p>



Unifomat Omniclass

N/A 23-13 23 11 Mechanical Fasteners – Undercut Anchor

Includes: Post-installed anchors per American Concrete Institute 318 building code.

Associated Masterformat Sections: N/A

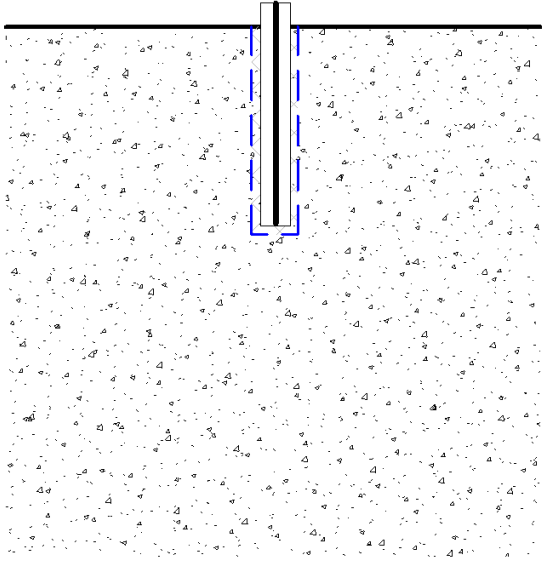
200	Refer to the model element of the main assembly being connected.	N/A
300	Refer to the model element of the main assembly being connected.	N/A
350	<p>Element modeling to include:</p> <ul style="list-style-type: none"> • Anchor Length • Embedment Length • Projection Length • Edge Distance Zone • Spacing Zone • Geometry, base size without threads <p>Required non-graphic information associated with model elements to include:</p> <ul style="list-style-type: none"> • Anchor materials defined • Anchor type defined • Base material type (steel, concrete, masonry, etc) • Base material strength • Base material condition (New, existing, cracked, uncracked, saturated, etc.) • Finishes, i.e. primed, galvanized, etc. • Hole preparation specification 	 <p><i>LOD 350 Undercut Anchor, From AscendBKF.org</i></p>

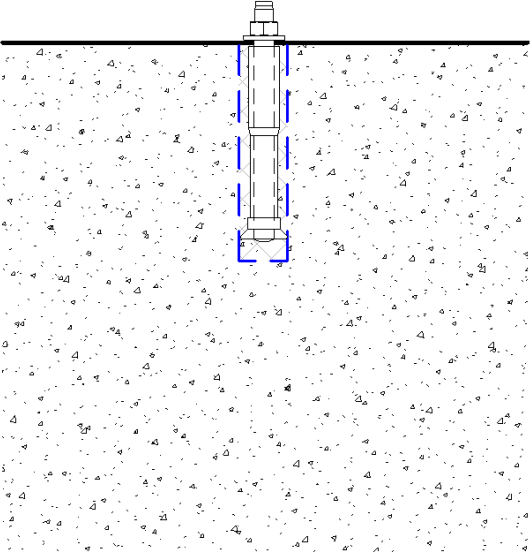

Unifomat Omniclass

400	<p>Element modeling to include fabrication level information:</p> <ul style="list-style-type: none">• Anchor Threads• Anchor Washers• Anchor Nuts <p>Other non-graphic information may be included such as:</p> <ul style="list-style-type: none">• Mark identification that correlates with bill of material (i.e., piece mark)• Member finish (primer, galvanized, etc.)• Fastener finish (i.e., black, zinc electroplated, hot-dipped galvanized)	 <p>The diagram shows a cross-section of a concrete slab with a horizontal surface line. An undercut anchor is embedded in the concrete. The anchor consists of a vertical threaded rod with a nut and washer at the top. The bottom of the rod is bent into a U-shape, creating an undercut. The concrete around the anchor is shown with a stippled texture. The anchor is highlighted with a blue outline.</p> <p><i>LOD 400 Undercut Anchor, From AscendBKF.org</i></p>
-----	--	--



Unifomat Omniclass

N/A 23-13 23 11 Mechanical Fasteners – Torque-controlled Expansion Anchor (Sleeve Type)

Includes: Post-installed anchors per American Concrete Institute 318 building code.

Associated Masterformat Sections: N/A

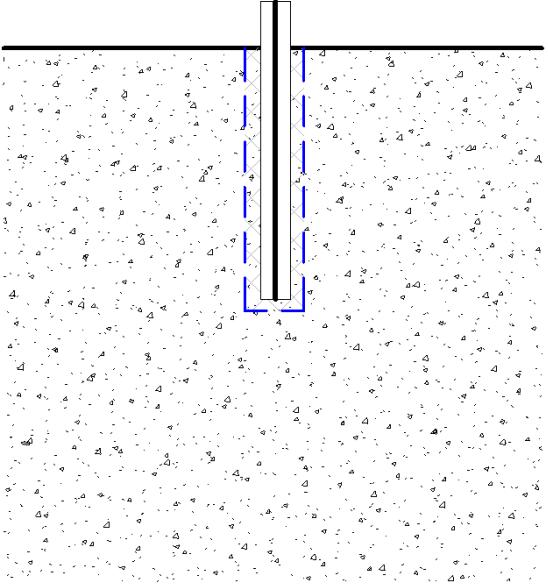
200	Refer to the model element of the main assembly being connected.	N/A
300	Refer to the model element of the main assembly being connected.	N/A
350	<p>Element modeling to include:</p> <ul style="list-style-type: none"> • Anchor Length • Embedment Length • Projection Length • Edge Distance Zone • Spacing Zone • Geometry, base size without threads <p>Required non-graphic information associated with model elements to include:</p> <ul style="list-style-type: none"> • Anchor materials defined • Anchor type defined • Base material type (steel, concrete, masonry, etc) • Base material strength • Base material condition (New, existing, cracked, uncracked, saturated, etc.) • Finishes, i.e. primed, galvanized, etc. • Hole preparation specification 	 <p><i>LOD 350 Torque-Controlled Expansion Anchor (Sleeve Type) , From AscendBKF.org</i></p>

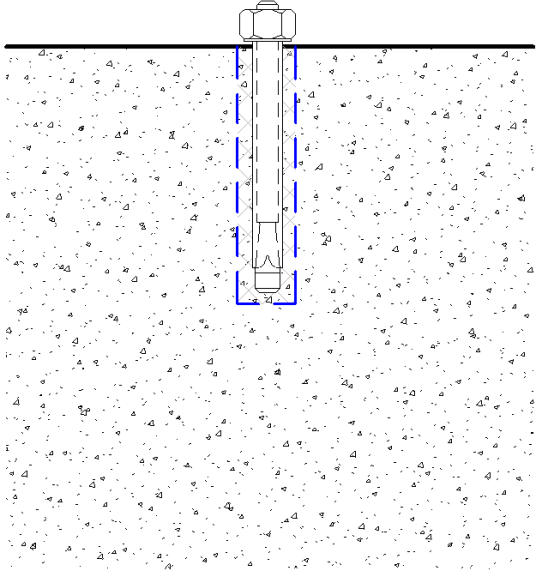

Unifomat Omniclass

400	<p>Element modeling to include fabrication level information:</p> <ul style="list-style-type: none">• Anchor Threads• Anchor Washers• Anchor Nuts <p>Other non-graphic information may be included such as:</p> <ul style="list-style-type: none">• Mark identification that correlates with bill of material (i.e., piece mark)• Member finish (primer, galvanized, etc.)• Fastener finish (i.e., black, zinc electroplated, hot-dipped galvanized)	 <p><i>LOD 400 Torque-Controlled Expansion Anchor (Sleeve Type) , From AscendBKF.org</i></p>
-----	--	---



Unifomat Omniclass

N/A 23-13 23 11 Mechanical Fasteners – Torque-controlled Expansion Anchor (Stud Type)

Includes: Post-installed anchors per American Concrete Institute 318 building code.

Associated Masterformat Sections: N/A

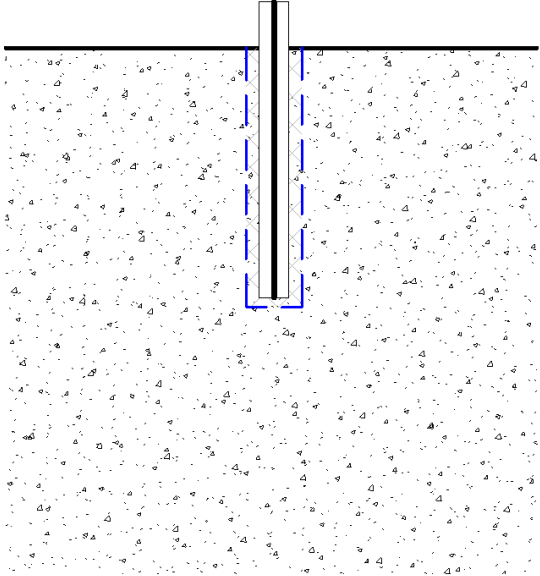
200	Refer to the model element of the main assembly being connected.	N/A
300	Refer to the model element of the main assembly being connected.	N/A
350	<p>Element modeling to include:</p> <ul style="list-style-type: none"> • Anchor Length • Embedment Length • Projection Length • Edge Distance Zone • Spacing Zone • Geometry, base size without threads <p>Required non-graphic information associated with model elements to include:</p> <ul style="list-style-type: none"> • Anchor materials defined • Anchor type defined • Base material type (steel, concrete, masonry, etc) • Base material strength • Base material condition (New, existing, cracked, uncracked, saturated, etc.) • Finishes, i.e. primed, galvanized, etc. • Hole preparation specification 	 <p><i>LOD 350 Torque-Controlled Expansion Anchor (Stud Type)</i>, From AscendBKF.org</p>

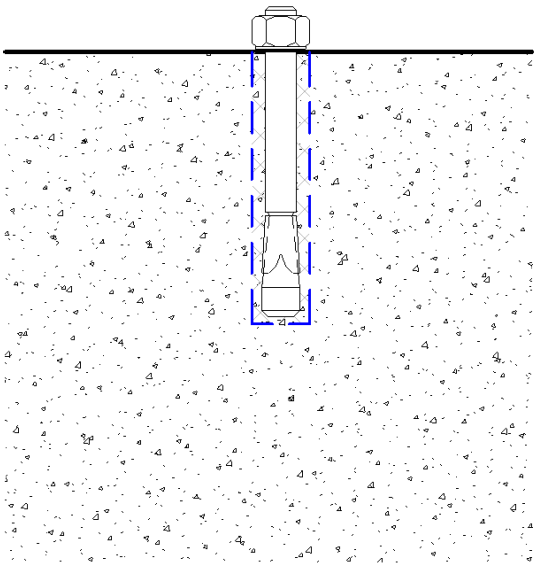

Unifomat Omniclass

<p>400</p>	<p>Element modeling to include fabrication level information:</p> <ul style="list-style-type: none">• Anchor Threads• Anchor Washers• Anchor Nuts <p>Other non-graphic information may be included such as:</p> <ul style="list-style-type: none">• Mark identification that correlates with bill of material (i.e., piece mark)• Member finish (primer, galvanized, etc.)• Fastener finish (i.e., black, zinc electroplated, hot-dipped galvanized)	 <p><i>LOD 400 Torque-Controlled Expansion Anchor (Stud Type) , From AscendBKF.org</i></p>
------------	--	---



Unifomat Omniclass

N/A 23-13 23 11 Mechanical Fasteners – Drop-in Type
Displacement-Controlled Expansion Anchor

Includes: Post-installed anchors per American Concrete Institute 318 building code.

Associated Masterformat Sections: N/A

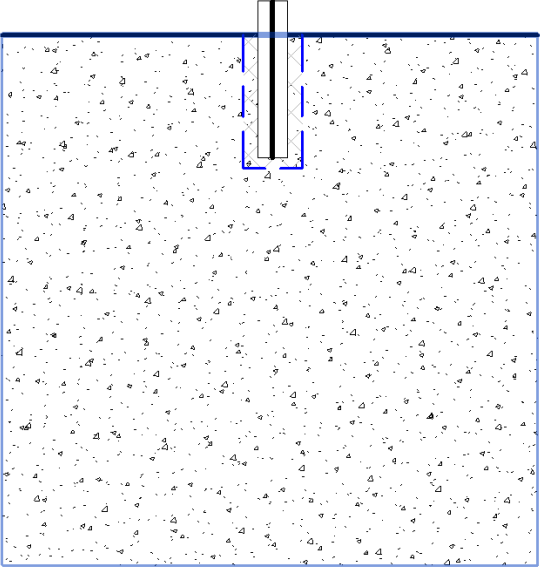
200	Refer to the model element of the main assembly being connected.	N/A
300	Refer to the model element of the main assembly being connected.	N/A
350	<p>Element modeling to include:</p> <ul style="list-style-type: none"> • Anchor Length • Embedment Length • Projection Length • Edge Distance Zone • Spacing Zone • Geometry, base size without threads <p>Required non-graphic information associated with model elements to include:</p> <ul style="list-style-type: none"> • Anchor materials defined • Anchor type defined • Base material type (steel, concrete, masonry, etc) • Base material strength • Base material condition (New, existing, cracked, uncracked, saturated, etc.) • Finishes, i.e. primed, galvanized, etc. • Hole preparation specification 	 <p><i>LOD 350 Drop-In Type Displacement-Controlled Expansion Anchor, From AscendBKF.org</i></p>



Unifomat Omniclass

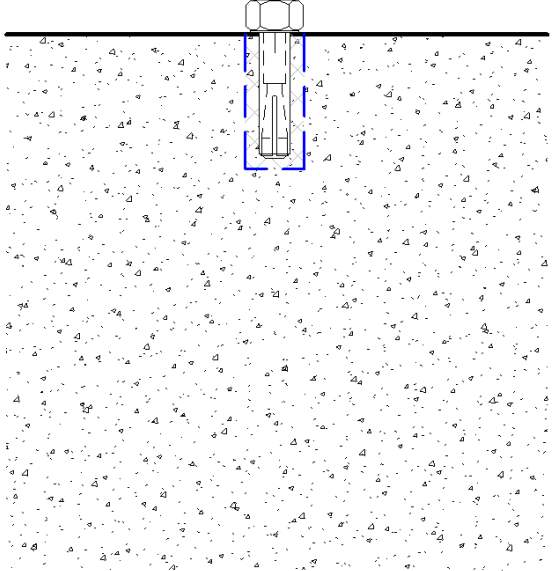

400	<p>Element modeling to include fabrication level information:</p> <ul style="list-style-type: none">• Anchor Threads• Anchor Washers• Anchor Nuts <p>Other non-graphic information may be included such as:</p> <ul style="list-style-type: none">• Mark identification that correlates with bill of material (i.e., piece mark)• Member finish (primer, galvanized, etc.)• Fastener finish (i.e., black, zinc electroplated, hot-dipped galvanized)	 <p><i>LOD 400 Drop-In Type Displacement-Controlled Expansion Anchor, From AscendBKF.org</i></p>
-----	--	---



Unifomat Omniclass

N/A 23-13 31 Structural Concrete Products

N/A 23-13 31 17 Formwork– Concrete Column
Associated Masterformat Sections: 03-10-00

<p>200</p>	<p>Element modeling to include:</p> <ul style="list-style-type: none"> • Approximate geometry (e.g. panel dimensions or depth). 	 <p><i>LOD 200 Concrete Column Formwork, From AscendBKF.org</i></p>
<p>300</p>	<p>Element modeling to include:</p> <ul style="list-style-type: none"> • Formwork materials are defined. These may include, but are not limited to plastic, wood or steel. • Material properties are defined. These may include, but are not limited to material finish, type, size, grade, strength, etc. • Products manufacturer is defined. 	 <p><i>LOD 300 Concrete Column Formwork, From AscendBKF.org</i></p>

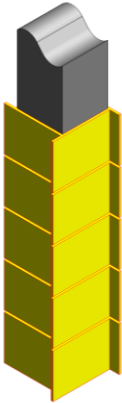
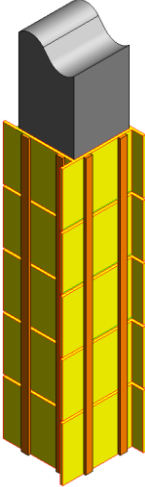

Unifomat Omniclass

<p>350</p>	<p>Element modeling to include:</p> <ul style="list-style-type: none"> • Insulating faces are defined. • Insulating details are defined. These include, but are not limited, too, the type of insulation specified, the temperature change the insulation will cause and the thickness of the insulation within the formwork. • Hardware and fastener specification defined (may include Nails, Wood Screws, Bolts, Lag Screws, Ties, Anchors, Hangers, etc.) • Shoring connections are defined. • Scaffolding connections are defined • Liner details are defined. 	 <p><i>LOD 350 Concrete Column Formwork, From AscendBKF.org</i></p>
<p>400</p>	<p>Element modeling to include:</p> <ul style="list-style-type: none"> • All connections, fasteners, and forms detailed and modeled. • Nails, Screws, Anchors, etc. 	 <p><i>LOD 400 Concrete Column Formwork, From AscendBKF.org</i></p>



Unifomat Omniclass

N/A 23-13 31 17

Formwork– Concrete Slab

Associated Masterformat Sections: 03-10-00

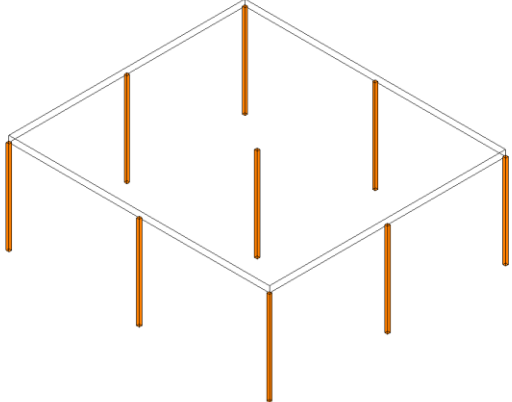
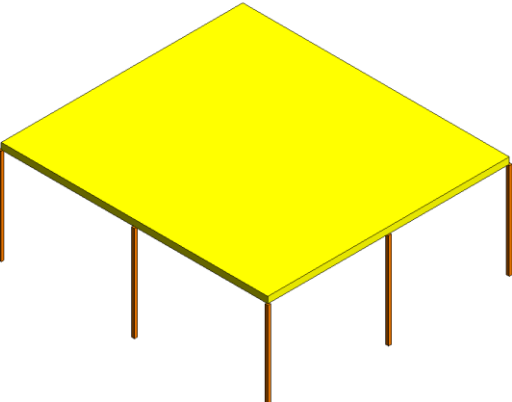
200	Element modeling to include: <ul style="list-style-type: none">• Approximate geometry (e.g. formwork dimensions or depth).	 <p><i>LOD 200 Concrete Slab Formwork, From AscendBKF.org</i></p>
300	Element modeling to include: <ul style="list-style-type: none">• Formwork materials are defined. These may include, but are not limited to plastic, wood or steel.• Material properties are defined. These may include, but are not limited to material finish, type, size, grade, strength, etc.• Products manufacturer is defined.	 <p><i>LOD 300 Concrete Slab Formwork, From AscendBKF.org</i></p>

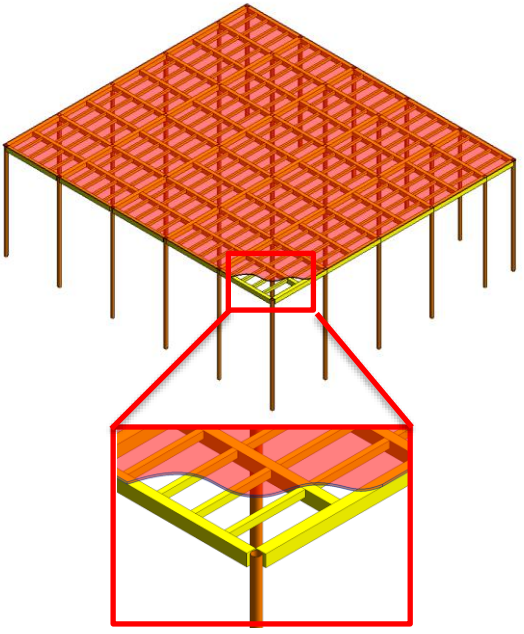

Unifomat Omniclass

350	<p>Element modeling to include:</p> <ul style="list-style-type: none">• Insulating faces are defined.• Insulating details are defined. These include, but are not limited to, the type of insulation specified, the temperature change the insulation will cause and the thickness of the insulation within the formwork.• Hardware and fastener specification defined (may include Nails, Wood Screws, Bolts, Lag Screws, Ties, Anchors, Hangers, etc.)• Shoring connections are defined.• Scaffolding connections are defined• Liner details are defined.	 <p><i>LOD 350 Concrete Slab Formwork</i>, From AscendBKF.org</p>
-----	--	--

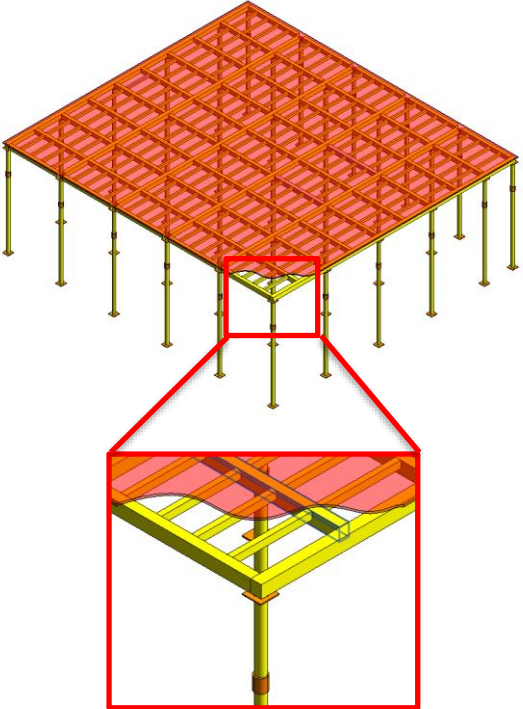

Unifomat Omniclass

<p>400</p>	<p>Element modeling to include:</p> <ul style="list-style-type: none"> • All supports and formwork detailed and modeled. • Wood supports, metal supports, plates, etc. 	 <p><i>LOD 400 Concrete Slab Formwork</i></p>
------------	--	--

N/A 35-51-11 11 11 11 Site Trailers
Includes: Temporary trailers, deck, stairs, ramps.

<p>100</p>	<p>Diagrammatic or schematic model elements: conceptual and/or schematic layout;</p>	
<p>200</p>	<p>Generic elements in schematic layout with: approximate size and location; approximate access/code clearance requirements modeled;</p>	
<p>300</p>	<p>Modeled as design-specified size, shape, spacing, and location of decking, stairs, ramps; access/code clearance requirements modeled.</p>	



Unifomat Omniclass

350	Modeled as actual size, shape, spacing, and location of decking, stairs, ramps; actual size, shape, spacing, and location for supports and seismic control; actual access/code clearance requirements modeled.	
400	Supplementary components added to the model required for field installation.	

N/A 35-51 11 11 11 27 Site Lighting

Description: Lighting equipment and accessories for temporary on-grade site lighting.

100	Diagrammatic or schematic model elements: conceptual and/or schematic layout;	
200	Generic elements in schematic layout with: approximate size, shape, and location of equipment; approximate access/code clearance requirements modeled; design performance parameters as defined in the BXP to be associated with model elements as non-graphic information.	
300	Modeled as design-specified size, shape, spacing, and location of temporary lighting fixtures; allowances for spacing and clearances for service/maintenance and code clearance requirements modeled.	
350	Modeled as actual size, shape, spacing, and location of lighting fixtures; actual access/code clearance requirements modeled.	
400		

N/A 35-51 17 27 Temporary Fencing

Description: Fencing material, posts, post footings, gates for temporary on site fencing.

100	Diagrammatic or schematic model elements: conceptual and/or schematic layout;	
200	Generic elements in schematic layout with: approximate size and location of fencing; approximate access/code clearance requirements modeled;	



Unifomat Omniclass

300	Modeled as design-specified size, shape, spacing, and location of temporary fencing; allowances for spacing and clearances for service/maintenance and code clearance requirements modeled.	
350	Modeled as actual size, shape, spacing, and location of temporary fencing; actual access/code clearance requirements modeled.	
400		

N/A 35-51 31 33 11 Cranes: Mobile
Includes: Mobile cranes and related accessories.

See [D1050](#)

N/A 35-51 31 33 16 Cranes: Tower
Includes: Tower cranes and related accessories.

See [D1050](#)

N/A 35-61 31 31 21 51 26 Batch Plants
Includes: cement silo, aggregate bin, aggregate conveyor and cement and aggregate batchers.

100	Diagrammatic or schematic model elements: conceptual and/or schematic layout;	
200	Generic elements in schematic layout with: approximate size and location; approximate access/code clearance requirements modeled;	
300	Modeled as design-specified size, shape, spacing, and location of equipment approximate allowances for spacing and clearances required for all specified supports and seismic control; access/code clearance requirements modeled.	
350	Modeled as actual size, shape, spacing, and location of equipment; actual size, shape, spacing, and location for supports and seismic control; actual access/code clearance requirements modeled.	



Unifomat Omniclass

400	Supplementary components added to the model required for field installation.	
-----	--	--

CIVIL

Highway Bridges Precast Structural I Girder (Concrete)

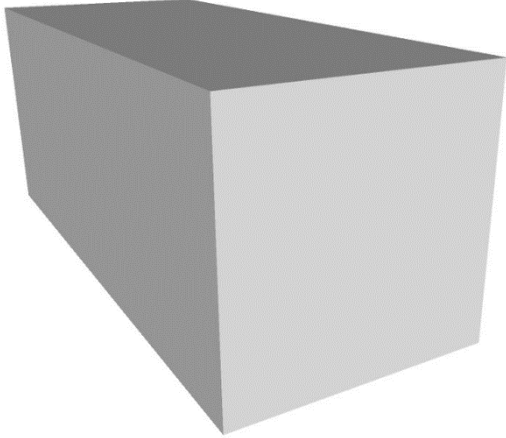
100		
200	<p>Element modeling to include:</p> <ul style="list-style-type: none">• Type of structural concrete system• Approximate geometry (e.g. depth) of structural elements	 <p><i>LOD 200 Highway Bridges Precast Structural I Girder (Concrete), From lkerd.com</i></p>

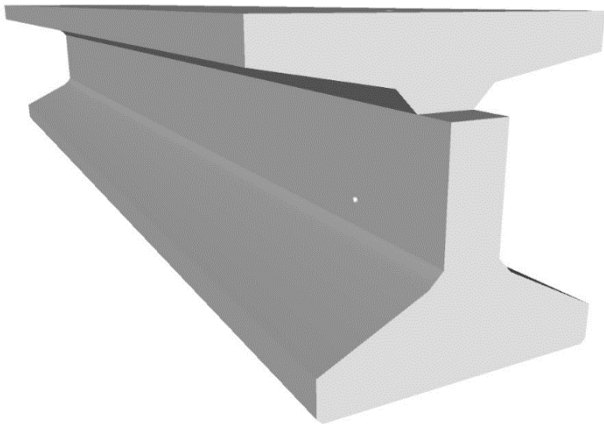
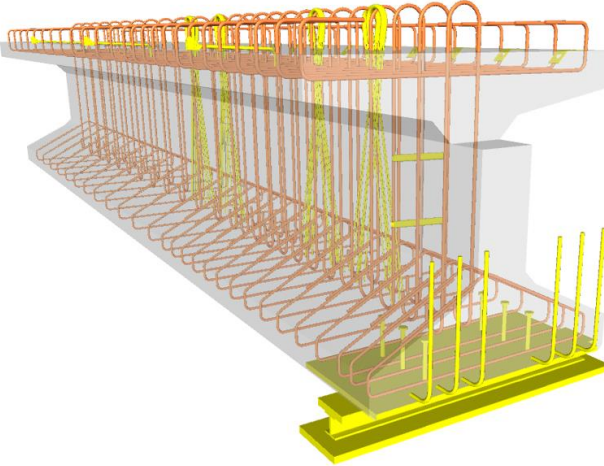

Unifomat Omniclass

<p>300</p>	<p>Element modeling to include:</p> <ul style="list-style-type: none"> • Specific sizes and locations of main concrete structural members modeled per defined structural grid with correct orientation • Concrete defined per spec (strength, air entrainment, aggregate size, etc.) • All sloping surfaces included in model element with exception of elements affected by manufacturer selection 	 <p><i>LOD 300 Highway Bridges Precast Structural I Girder (Concrete) , From lkerd.com</i></p>
<p>350</p>	<p>Element modeling to include:</p> <ul style="list-style-type: none"> • Reinforcing Post-tension profiles and strand locations • Reinforcement called out, modeled if required by the BXP, typically only in congested areas • Chamfer • Pour joints and sequences to help identify reinforcing lap splice locations, scheduling, etc. • Expansion Joints • Lifting devices • Embeds and anchor rods • Post-tension profile and strands modeled if required by the BXP • Penetrations for items such as MEP • Any permanent forming or shoring components 	 <p><i>LOD 350 Highway Bridges Precast Structural I Girder (Concrete) , From lkerd.com</i></p>

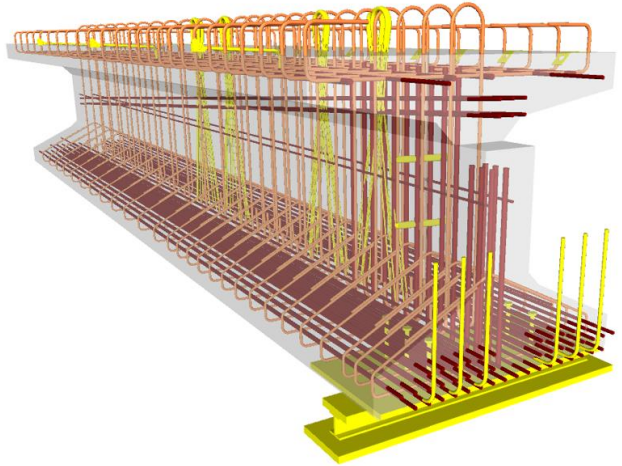

Unifomat Omniclass

400	<p>Element modeling to include:</p> <ul style="list-style-type: none">All reinforcement including post tension elements detailed and modeled	 <p><i>LOD 400 Highway Bridges Precast Structural I Girder (Concrete) , From lkerd.com</i></p>
-----	--	---



Unifomat Omniclass

Highway Bridge Girder Steel

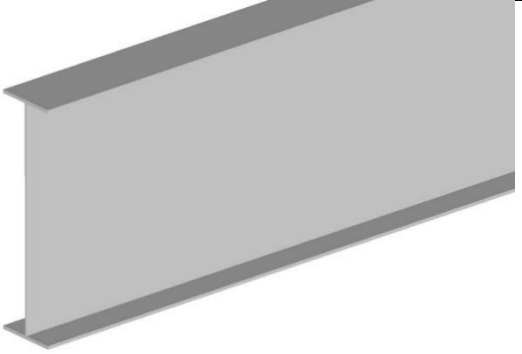
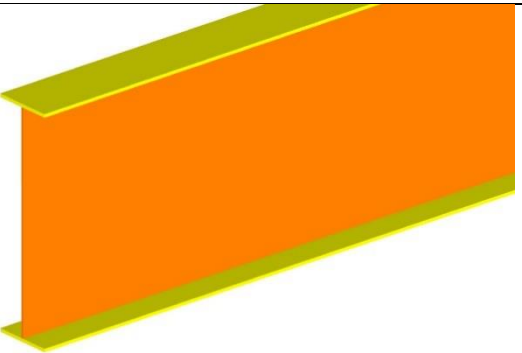
200	Generic mass of Girder	 <p><i>LOD 200 Highway Bridge Girder Steel, From lkerd.com</i></p>
300	Element modeling to include <ul style="list-style-type: none">3) Girder Depth4) Web Plate Length<ul style="list-style-type: none">• Flange Plate Width	 <p><i>LOD 300 Highway Bridge Girder Steel, From lkerd.com</i></p>

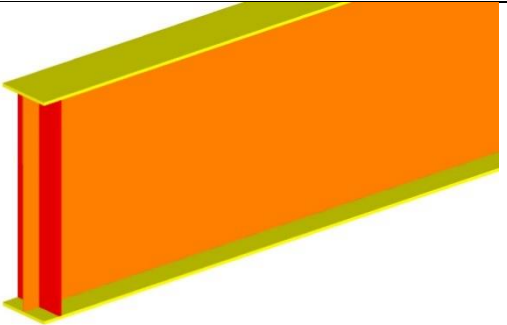
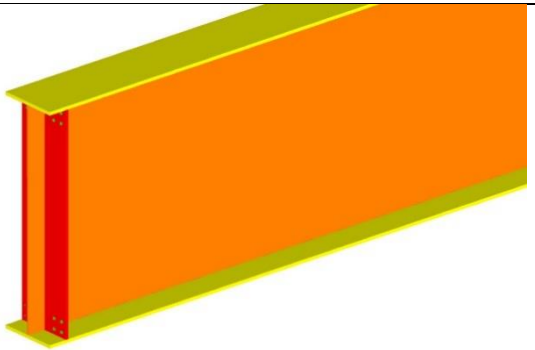

Unifomat Omniclass

350	<p>Element modeling to include:</p> <ul style="list-style-type: none"> • Stiffeners • Exact sloping of members • Splits between Plate Girders 	 <p><i>LOD 350 Highway Bridge Girder Steel, From lkerd.com</i></p>
400	<p>Element modeling to include fabrication level information:</p> <ul style="list-style-type: none"> • Welds • Coping of members • Washers, nuts, etc. • Grating, holes in grating • All assembly elements 	 <p><i>LOD 400 Highway Bridge Girder Steel, From lkerd.com</i></p>

Railroad Bridges Precast Structural I Girder (Concrete)

100		
-----	--	--

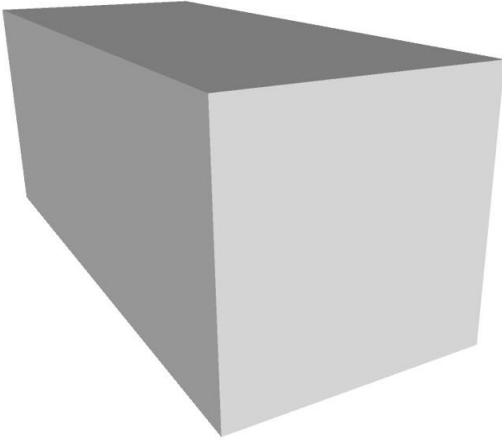
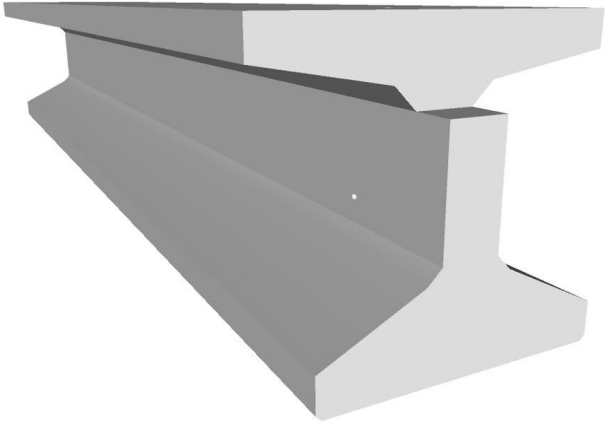

Unifomat Omniclass

<p>200</p>	<p>Element modeling to include:</p> <ul style="list-style-type: none"> • Type of structural concrete system • Approximate geometry (e.g. depth) of structural elements 	 <p><i>LOD 200 Railroad Bridges Precast Structural I Girder (Concrete) , From lkerd.com</i></p>
<p>300</p>	<p>Element modeling to include:</p> <ul style="list-style-type: none"> • Specific sizes and locations of main concrete structural members modeled per defined structural grid with correct orientation • Concrete defined per spec (strength, air entrainment, aggregate size, etc.) • All sloping surfaces included in model element with exception of elements affected by manufacturer selection 	 <p><i>LOD 300 Railroad Bridges Precast Structural I Girder (Concrete) , From lkerd.com</i></p>

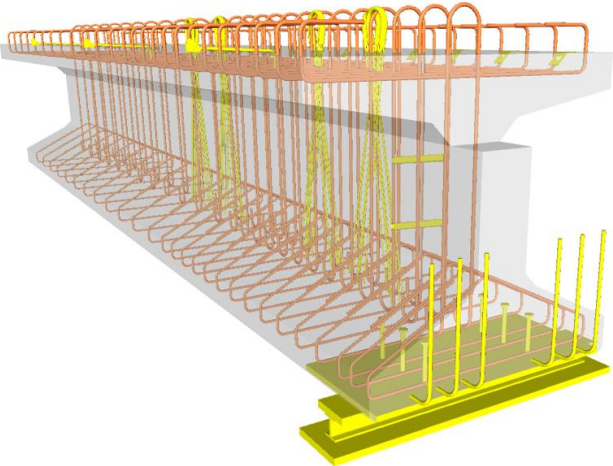
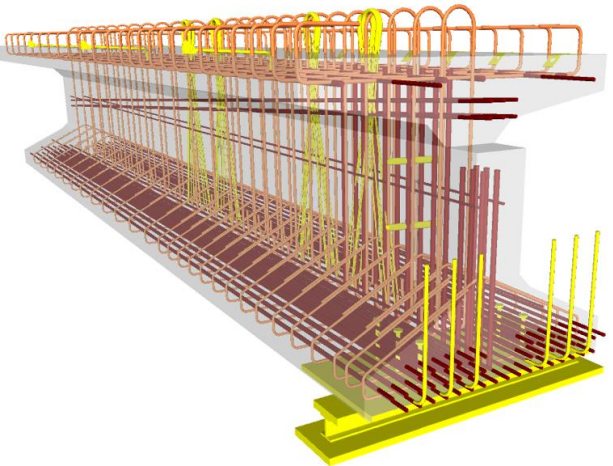

Unifomat Omniclass

<p>350</p>	<p>Element modeling to include:</p> <ul style="list-style-type: none"> • Reinforcing Post-tension profiles and strand locations • Reinforcement called out, modeled if required by the BXP, typically only in congested areas • Pour joints and sequences to help identify reinforcing lap splice locations, scheduling, etc. • Chamfer • Expansion Joints • Lifting devices • Embeds and anchor rods • Post-tension profile and strands modeled if required by the BXP • Penetrations for items such as MEP • Any permanent forming or shoring components 	 <p><i>LOD 350 Railroad Bridges Precast Structural I Girder (Concrete) , From lkerd.com</i></p>
<p>400</p>	<p>Element modeling to include:</p> <ul style="list-style-type: none"> • All reinforcement including post tension elements detailed and modeled • Finishes 	 <p><i>LOD 400 Railroad Bridges Precast Structural I Girder (Concrete) , From lkerd.com</i></p>

Railroad Bridge Girder Steel

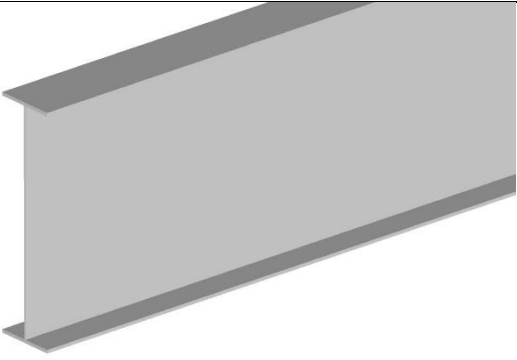
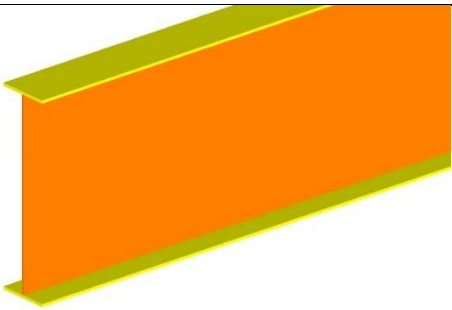
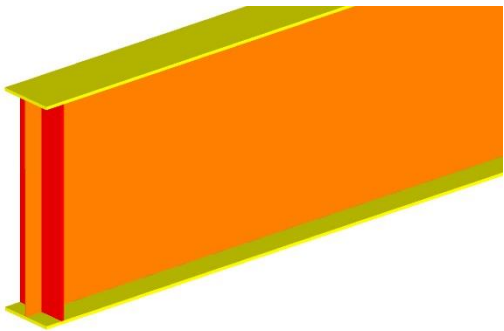

Unifomat Omniclass

<p>200</p>	<p>Generic mass of Girder</p>	 <p><i>LOD 200 Railroad Bridge Girder Steel, From lkerd.com</i></p>
<p>300</p>	<p>Element modeling to include:</p> <ul style="list-style-type: none"> • Girder Depth • Web Plate Length • Flange Plate Width 	 <p><i>LOD 300 Railroad Bridge Girder Steel, From lkerd.com</i></p>
<p>350</p>	<p>Element modeling to include:</p> <ul style="list-style-type: none"> • Stiffeners • Exact sloping of members • Splits between Plate Girders 	 <p><i>LOD 350 Railroad Bridge Girder Steel, From lkerd.com</i></p>

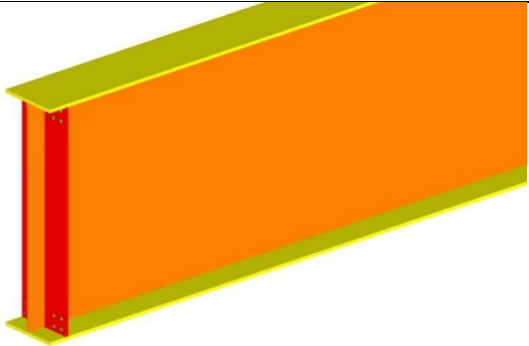

Unifomat Omniclass

400	<p>Element modeling to include fabrication level information:</p> <ul style="list-style-type: none">• Welds• Coping of members• Washers, nuts, etc.• Grating, holes in grating• All assembly elements	 <p><i>LOD 400 Railroad Bridge Girder Steel, From lkerd.com</i></p>
-----	---	--



2020

LEVEL OF DEVELOPMENT (LOD) SPECIFICATION COMMENTARY

For Building Information Models and Data

December 2020

Committee Co-Chairs
 Jim Bedrick, FAIA, Will Ikerd, P.E., Jan Reinhardt

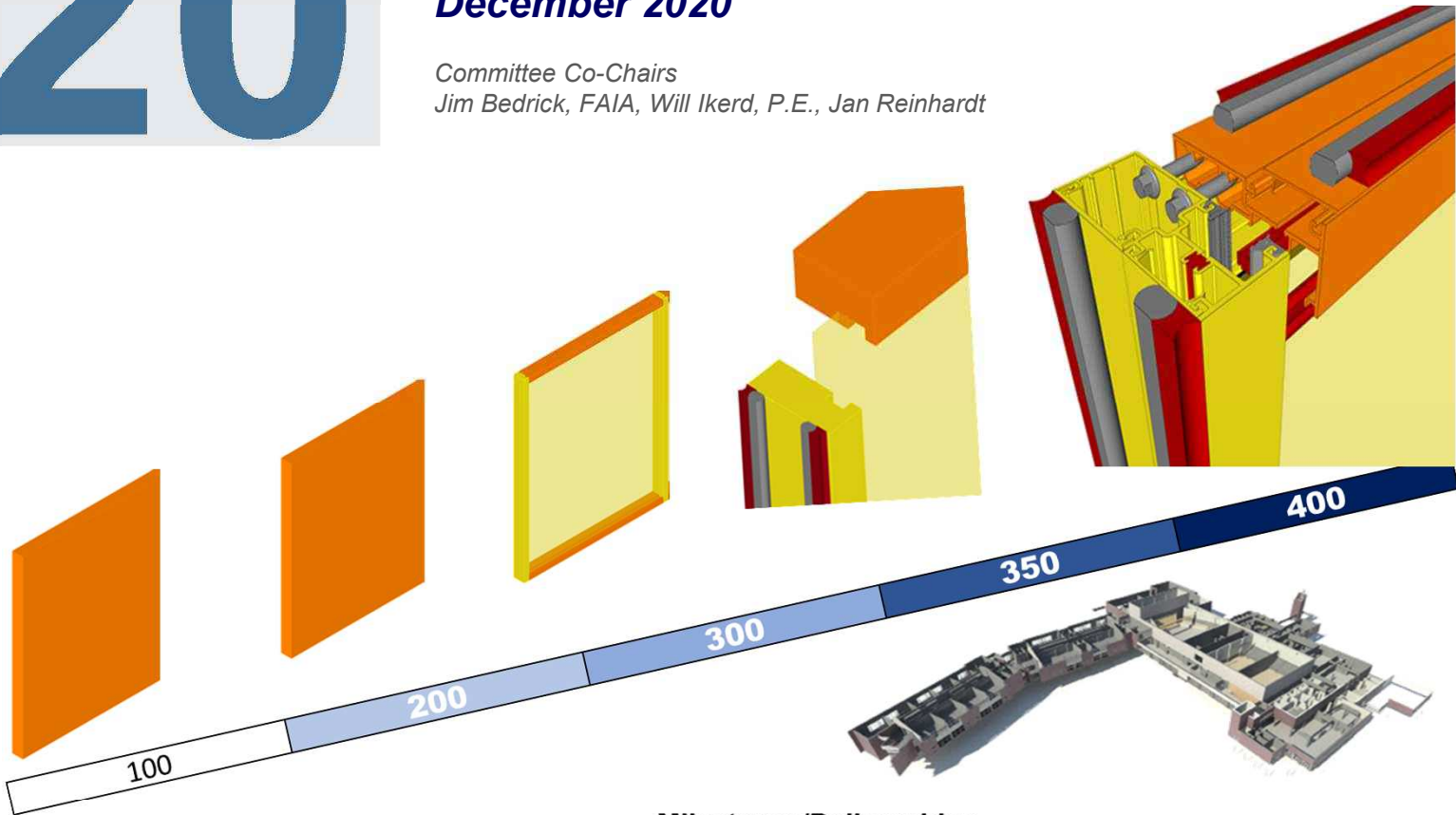

Milestones/Deliverables

		SD		DD		CD	Constr. Coord.	Fabrication
Building Systems	—							
	—							
	—							
	—							
	—							
	—							
	—							
	—							

PARTICIPATING ORGANIZATIONS



LOD Spec 2020

For Building Information Models

GUIDE AND COMMENTARY

August 2020

Nothing contained in this work shall be considered the rendering of legal advice. Readers are responsible for obtaining such advice from their own legal counsel. This work and any forms herein are intended solely for educational and informational purposes.

All images are intended to illustrate building conditions in compliance with common building codes. However, the images do not take into account site specific conditions, regional building codes and other important information that may require a material change for specific projects. These illustrations do not make representation for fitness for a particular project nor for code or design compliance.

Copyright © 2020 by BIMForum. All rights reserved

The LOD Specification Part I and Part II as well as the LOD Specification Guide are made available to the public without charge. In order to maintain the integrity and usefulness of these documents as a reference standard, certain restrictions apply to their use. These documents are licensed to the public under Creative Commons licenses as follows:

Part I of this work is licensed under the Creative Commons Attribution-NonCommercial-NoDerivatives 4.0 International License (<http://creativecommons.org/licenses/by-nc-nd/4.0/>).

Part II of this work is licensed under the Creative Commons Attribution-NonCommercial 4.0 International License (<http://creativecommons.org/licenses/by-nc/4.0/>).

The LOD Spec Guide is licensed under the Creative Commons Attribution-NonCommercial-NoDerivatives 4.0 International License (<http://creativecommons.org/licenses/by-nc-nd/4.0/>).

Licensing questions should be directed to LOD@BIMForum.org.



ACKNOWLEDGEMENTS

Many thanks to all the individuals and organizations who reviewed and contributed to this work, and to the following industry association representatives and co-chairs of the major discipline subgroups who made this document possible:

Chairs

Overall

Jim Bedrick, FAIA, AEC Process Engineering
Will Ikerd, PE, IKERD Consulting LLC
Jan Reinhardt, Adept Project Delivery

Domain Groups	Design	Construction
Structures	Will Ikerd, PE, LEED AP IKERD	David Merrifield National Institute of Steel Detailers
Exterior Skin	Michael F. Czap, AIA The Beck Group	Will Ikerd, P.E. IKERD
Interior Construction	Ron Dellaria, AIA, CSI Collaborative Construction Consultants	Brian Filkins The Beck Group South Cole Texas Steel Tech LLC
Conveying	Brian Skripac, Assoc. AIA, LEED AP BD+C Cannon Design	Ken Flannigan, LEED AP KONE
Building Services	Mark Mergenschroer Bernhardt TME Joseph Powell IKERD	David Francis ICT Tracker
Civil	Will Ikerd, PE, LEED AP IKERD	Jake Fears, PE JHF Engineering
Landscape	Elise Bertret Tract Consultants Will Ikerd, PE, LEED AP IKERD	Jan Reinhardt, Adept Project Delivery Jake Fears, PE JHF Engineering
Bridge: Highway & Rail	Will Ikerd, PE, LEED AP IKERD	David Merrifield National Institute of Steel Detailers
Estimating with BIM	Brent pilgrim Beck Group Michael Perdue IKERD	Ryan Short Rudick Construction Nicholas Grinnan Rudick Construction
Data with BIM	Michael Perdue IKERD	Jan Reinhardt, Adept Project Delivery
Legal	Carl G. Roberts, Law Offices of Carl G. Roberts LLC	



Industry Association Representatives

Michael Bomba, Esq., American Institute of Architects

Overall Editing and Graphics Creation

Ascend Building Knowledge Foundation (AscendBKF.org), Technical Writing, Editing & Graphics
IKERD Consulting, LLC (IKERD.com), Editing
BIMxD Solutions, LLC (BIMxD.com), Graphics

Additional Contributors

In addition, we'd like to thank the many contributors from all sectors of the industry who helped make this specification possible, including:

Andy Jizba, US CAD

Benjamin Crosby, Yates Construction

Bill Klorman, Klorman Construction & ACI 131 BIM Committee Member (Concrete)

Brenda Ikerd, IKERD Consulting, IKERD.com (Structures, Civil)

Chuck Eastman, Ph.D, Georgia Institute of Technology

Jamie L. Davis, PE, LEED AP, Ryan Biggs | Clark Davis Engineering & Surveying (Masonry)

Jason P. Lien, PE, Precast Concrete Institute (PCI) BIM Committee, EnCon United (Precast)

Jonathan Koller, IKERD Consulting, IKERD.com (Graphics Editing, Structures, and Anchors)

Joe Cipra, Vulcraft/Verco Group (Structural Steel Open Web Joists and Metal Deck)

Joe Powell, EIT, Ikerd Consulting, IKERD.com (MEP)

Kirk Capristo, Astorino (Cover)

Lee Garduno, Southland Industries (MEP)

Luke Faulkner, LEED AP, AISC (Structural Steel)

Matthew J. Gomez PE, SE, Trimble (Structural Steel)

Michael Bolduc, PE (MA), Simpson Gumpertz & Heger (Structural)

Michael Gustafason, PE, Autodesk (Structural)

Michael Mulder, Southland Industries (MEP)

Michael Perdue, Ikerd Consulting, IKERD.com (LOD Part II Data Tables)

Murat Karakas, Arup (MEP)

Paul J. Hause, PE, Structural Consultants Inc. (Structural)

Peter J. Carrato, Ph.D., PE, SE, Bechtel & ACI 131 BIM Committee Chair (Concrete)

R. Wayne Muir, P.E., Structural Consultants Inc. & SEI-CASE BIM Committee Co-Chair (Structures)

Roger Becker, PE, SE, Precast Concrete Institute (PCI) Managing Director of Research and Development (Precast)

Scott Babin, ITW Building Components Group (Wood)

Soheil Seiqali, Klorman Construction (Concrete)

Steven Bumbalough (Wood)

William Northcutt, IKERD Consulting, IKERD.com (Graphics Editing, Structures, and Anchors)



EXECUTIVE SUMMARY

The Level of Development (LOD) Specification is a reference tool intended to improve the quality of communication among users of Building Information Models (BIMs) about the characteristics of elements in models. The LOD Specification expands upon the LOD schema developed by the American Institute of Architects (AIA) for its E202-2009 BIM and Digital Data Exhibit and updated for the AIA's G202-2013 Project BIM Protocol Form by providing definitions and illustrations of BIM elements of different building systems at different stages of their development and use in the design and construction process.

Building Information Modeling presents information about a construction project or structure in the form of three-dimensional graphical representations of elements (e.g., doors, beams, etc.), which can be further associated with information about other characteristics of those elements. It is possible for the graphical representation of an element, taken alone, to suggest that greater accuracy or intention can be attributed to the element than is in fact the case. The AIA's LOD Schema was developed to provide a more systematic way of conveying the extent of reliance that may be placed on an element. Many participants in the design and construction process felt, however, that the AIA's brief narrative definitions left too much room for interpretation.

Discussions within the BIMForum led to the creation by a multi-disciplinary task force of the LOD Specification. The LOD Specification is an organized collection of interpretations of the AIA's LOD definitions describing input and information requirements and providing graphical examples of the different levels of development of a broad variety of building element classes.

Users of the LOD Specification are cautioned that the LOD Specification does not prescribe the necessary levels of development for different steps in the construction process. That determination is left to each project team. It is believed, however, that the availability of more precise definitions will reduce the risks of miscommunication among members of project teams when the expectations for different stages in the design and construction process are established, through easier identification of what each member of the team is expected to deliver and greater predictability of the level of effort that is required to create each member's deliverables.

The LOD Specification is organized by CSI Uniformat 2010, with the subclasses expanded to Level 4 (and in a few cases to Level 5) to provide detail and clarity to the element definitions. The LOD Specification addresses only LOD 100 through LOD 400 of the AIA's LOD Schema, along with a new level – LOD 350 – which was added between LOD 300 and LOD 400 to better address the information levels required for effective trade coordination. The LOD Specification does not address LOD 500 since that LOD relates to field verification and is not an indication of progression to a higher level of geometry or information.

The BIMForum's interpretation of the LOD definitions are as follows:

LOD 100 elements are not geometric presentations. They may be symbols or other generic representations of information that can be derived from other model elements. Any information derived from LOD 100 elements must be considered approximate.

LOD 200 elements are represented graphically but are generic placeholders, e.g., volume, quantity, location, or orientation. Any information derived from LOD 200 elements must be considered approximate.

LOD 300 elements are graphically represented as specific systems, objects, or assemblies from which quantity, shape, size, location, and orientation can be measured directly, without having to refer to non-modeled information such as notes or dimension call-outs.

LOD 350 elements are enhanced beyond LOD 300 by the addition of information regarding interfaces with other building systems. For example, an LOD 350 masonry wall element would include jamb conditions, bond beams, grouted cells, dowel locations, and joints – information that enables the model user to coordinate the wall element with other systems in the structure.

LOD 400 elements are modeled at sufficient detail and accuracy for fabrication of the represented component.

The LOD Specification does not prescribe who the author of a particular component at a given LOD should be, as that will vary from one project to another. However, the document does provide a concise schematic means through the spreadsheet in Part II for a project team to identify model element authors, again in the interest of improving communication among model users. In addition, the LOD Specification task force has been working with software developers to provide a means within the software of tagging individual elements within a model with their current LOD level.

The LOD Specification is intended as a reference standard, but is also intended to evolve as the use of BIM develops. The Specification is updated annually, and previous versions are maintained on the BIMForum website (www.bimforum.org/lo). Users are invited to provide comments and recommendations for consideration in future editions.



CONTENTS

EXECUTIVE SUMMARY	5
CHANGES FROM 2019 VERSION	12
UPDATES OF THIS DOCUMENT	13
FUNDAMENTAL LOD DEFINITIONS	15
PART I – ELEMENT GEOMETRY	17
N/A 36-51 OFFICE RESOURCES	17
N/A 36-51 73 11 13 11 19 SPACES	17
N/A 36-51 73 11 13 17 11 Horizontal Grids	18
N/A 36-51 73 11 13 17 13 Vertical Levels.....	18
A 21-01 SUBSTRUCTURE	20
A10 21-01 10 Foundations	20
A1010 21-01 10 10 Standard Foundations	20
A1020 21-01 10 20 Special Foundations.....	26
A20 21-01 20 Subgrade Enclosures.....	31
A2010 21-01 20 10 Walls for Subgrade Enclosures	32
A40 21-01 40 Slabs-on-Grade	33
A4010 21-01 40 10 Standard Slabs-on-Grade	33
A4020 21-01 40 20 Structural Slabs-on-Grade	34
A4030 21-01-40-30 Slab Trenches TBD	35
A4040 21-01-40-40 Pits and Bases TBD.....	35
A4090 21-01-40-90 Slab-On-Grade Supplementary Components TBD	36
A60 21-01-60 Water and Gas Mitigation TBD	36
A6010 21-01-60-10 Building Subdrainage TBD.....	36
A6020 21-01-60-20 Off-Gassing Mitigation TBD	36
A90 21-01-90 Substructure Related Activities TBD.....	36
A9010 21-01-90-10 Substructure Excavation TBD.....	36
A9020 21-01-90-20 Construction Dewatering TBD	36
A9030 21-01-90-30 Excavation Support TBD	36
A9040 21-01-90-40 Soil Treatment TBD	36
B 21-02 00 00 SHELL	37
B10 21-02 10 Superstructure	37
B1010 21-02 10 10 Floor Construction.....	37
B1020 21-02 10 20 Roof Construction	60
B1080 21-02 10 80 Stairs	61
B20 21-02 20 Exterior Vertical Enclosures.....	69
B2010 21-02 20 10 Exterior Walls	70
B2020 21-02 20 20 Exterior Windows	83
B2050 21-02 20 50 Exterior Doors and Grilles	88
B2070 Exterior Louvers and Vents	90



B30	21-02 30 Exterior Horizontal Enclosures.....	92
B3010	21-02 30 10 Roofing.....	92
B3020	21-02 30 20 Roof Appurtenances	93
B3040	21-02 30 40 Traffic Bearing Horizontal Enclosures	94
B3060	21-02 30 60 Horizontal Openings.....	96
B3080	21-02 30 80 Overhead Exterior Enclosures	96
C	21-03 INTERIORS.....	98
C10	21-03 10 Interior Construction.....	98
C1010	21-03 10 10 Interior Partitions	98
C1020	21-03 10 20 Interior Windows	109
C1030	21-03 10 30 Interior Doors	110
C1040	21-03 10 40 Interior Grilles and Gates	113
C1060	21-03 10 60 Raised Floor Construction.....	113
C1070	21-03 10 70 Suspended Ceiling Construction	114
C1090	21-03 10 90 Interior Specialties.....	116
C20	21-03 20 Interior Finishes	118
C2010	21-03 20 10 Wall Finishes.....	118
C2020	21-03 20 20 Interior Fabrications	120
C2030	21-03 20 30 Flooring.....	120
C2040	21-03 20 40 Stair Finishes	123
C2050	21-03 20 50 Ceiling Finishes.....	123
D	21-04 00 00 SERVICES	124
D10	21-04 10 Conveying.....	124
D1010	21-04 10 10 Vertical Conveying Systems.....	124
D1030	21-04 10 30 Horizontal Conveying	128
D1050	21-04 10 50 Material Handling	128
D1080	21-04 10 80 Operable Access Systems	132
D20	21-04 20 Plumbing.....	133
D2010	21-04 20 10 Domestic Water Distribution.....	133
D2020	21-04 20 20 Sanitary Drainage	138
D2030	21-04 20 30 Building Support Plumbing Systems	141
D2050	21-04 20 50 General Service Compressed-Air.....	146
D2060	21-04 20 60 Process Support Plumbing Systems	146
D30	21-04 30 Heating, Ventilation, and Air Conditioning (HVAC)	148
D3010	21-04 30 10 Facility Fuel Systems	148
D3020	21-04 30 20 Heating Systems	152
D3030	21-04 30 30 Cooling Systems	154
D3050	21-04 30 50 Facility HVAC Distribution Systems	157
D3060	21-04 30 60 Ventilation	160
D3070	21-04 30 70 Special Purpose HVAC Systems	164
D40	21-04 40 Fire Protection	165



D4010	21-04 40 10 Fire Suppression	165
D4030	21-04 40 30 Fire Protection Specialties.....	167
D50	21-04 50 Electrical	168
D5010	21-04 50 10 Facility Power Generation	168
D5020	21-04 50 20 Electrical Service and Distribution.....	170
D5030	21-04 50 30 General Purpose Electrical Power	174
D5040	21-04 50 40 Lighting	176
D5080	21-04 50 80 Miscellaneous Electrical Systems	178
D60	21-04 60 Communications	179
D6010	21-04 60 10 Data Communications.....	180
D6020	21-04 60 20 Voice Communications	182
D6030	21-04 60 30 Audio-Video Communication.....	182
D6060	21-04 60 60 Distributed Communications and Monitoring.....	182
D6090	21-04 60 90 Communications Supplementary Components	182
D70	21-04 70 Electronic Safety and Security	182
D7010	21-04 70 10 Access Control and Intrusion Detection	182
D7030	21-04 70 30 Electronic Surveillance.....	182
D7050	21-04 70 50 Detection and Alarm.....	183
D7070	21-04 70 70 Electronic Monitoring and Control	183
D7090	21-04 70 90 Electronic Safety and Security Supplementary Components	183
D80	21-04 80 Integrated Automation.....	183
D8010	21-04 80 10 Integrated Automation Facility Controls	183
E	21-05 00 00 EQUIPMENT & FURNISHINGS	184
E10	21-05 10 Equipment.....	184
E1010	21-05 10 10 Vehicle and Pedestrian Equipment	184
E1030	21-05 10 30 Commercial Equipment.....	185
E1040	21-05 10 40 Institutional Equipment.....	187
E1060	21-05 10 60 Residential Equipment	188
E1070	21-05 10 70 Entertainment and Recreational Equipment.....	188
E1090	21-05 10 90 Other Equipment Associated Masterformat Sections: 11 90 00.....	189
E20	21-05 20 Furnishings	190
E2010	21-05 20 10 Fixed Furnishings.....	190
E2050	21-05 20 50 Movable Furnishings	191
F	21-06 00 00 SPECIAL CONSTRUCTION & DEMOLITION.....	193
F10	21-06 10 Special Construction	193
F1010	21-06 10 10 Integrated Construction	193
F1020	21-06 10 20 Special Structures	193
F1030	21-06 10 30 Special Function Construction.....	201
F1050	21-06 10 50 Special Facility Components	201
F1060	21-06 10 60 Athletic and Recreational Special Construction.....	201
F1080	21-06 10 80 Special Instrumentation.....	202



F20	21-06 20 Facility Remediation Associated Masterformat Sections:	202
F2010	21-06 20 10 Hazardous Materials Remediation	202
F30	21-06 30 Demolition	202
F3010	21-06 30 10 Structure Demolition	202
F3030	21-06 30 30 Selective Demolition	202
F3050	21-06 30 50 Structure Moving	202
G10	21-07 10 Site Preparation	202
G1010	21-07 10 10 Site Clearing	203
G1020	21-07 10 20 Site Elements Demolition	203
G1030	21-07 10 30 Site Element Relocations	203
G1050	21-07 10 50 Site Remediation	203
G1070	21-07 10 70 Site Earthwork	203
G20	21-07 20 Site Improvements	204
G2010	21-07 20 10 Roadways	205
G2020	21-07 20 20 Parking Lots	205
G2030	21-07 20 30 Pedestrian Plazas and Walkways	206
G2040	21-07 20 40 Airfields	207
G2050	21-07 20 50 Athletic, Recreational, and Playfield Areas	207
G2060	21-07 20 60 Site Development	208
G2080	21-07 20 80 Landscaping	208
G30	21-07 30 Liquid and Gas Site Utilities	208
G3010	21-07 30 10 Water Utilities	209
G3020	21-07 30 20 Sanitary Sewerage Utilities	209
G3030	21-07 30 30 Storm Drainage Utilities	210
G3050	21-07 30 50 Site Energy Distribution	210
G3060	21-07 30 60 Site Fuel Distribution	210
G3090	21-07 30 90 Liquid and Gas Site Utilities Supplementary Components	211
G40	21-07 40 Electrical Site Improvements	211
G4050	21-07 40 50 Site Lighting	212
G50	21-07 50 Site Communications	213
G5010	– Site Communications Systems	213
G90	21-07 90 Miscellaneous Site Construction	214
G9010	21-07 90 10 Tunnels	214
N/A	22-31 23 16 13 Trenches	215
N/A	23-13 STRUCTURAL AND EXTERIOR ENCLOSURE PRODUCTS	216
N/A	23-13-23 Mechanical Fasteners, Adhesives, and Sealants	216
N/A	23-13 23 11 Mechanical Fasteners – L-Bolt	216
N/A	23-13 23 11 Mechanical Fasteners – J-Bolt	218
N/A	23-13 23 11 Mechanical Fasteners – Hex Head Bolt with Washer	219
N/A	23-13 23 11 Mechanical Fasteners – Welded Headed Stud Bolt	221
N/A	23-13 23 11 Mechanical Fasteners – Adhesive Anchor	222



N/A 23-13 23 11 Mechanical Fasteners – Undercut Anchor 224

N/A 23-13 23 11 Mechanical Fasteners – Torque-controlled Expansion Anchor (Sleeve Type) 226

N/A 23-13 23 11 Mechanical Fasteners – Torque-controlled Expansion Anchor (Stud Type) 228

N/A 23-13 23 11 Mechanical Fasteners – Drop-in Type Displacement-Controlled Expansion Anchor 230

N/A 23-13 31 Structural Concrete Products 232

N/A 23-13 31 17 Formwork– Concrete Column 232

N/A 23-13 31 17 Formwork– Concrete Slab..... 234

N/A 35-51-11 11 11 11 Site Trailers 236

N/A 35-51 11 11 11 27 Site Lighting 237

CIVIL 239

Highway Bridges Precast Structural I Girder (Concrete) 239

Highway Bridge Girder Steel 242

Railroad Bridges Precast Structural I Girder (Concrete)..... 243

Railroad Bridge Girder Steel..... 245

GUIDE AND COMMENTARY 249

EXECUTIVE SUMMARY 252

CONTENTS 253

CHANGES FROM 2019 VERSION 259

UPDATES OF THIS DOCUMENT 260

1 OVERVIEW 260

1.1 Description 260

1.1.1 LODs and Design Phase 261

1.1.2 LODs and Model Definition 261

1.2 Intent 261

1.2.1 Not a set of Requirements 261

1.2.2 Complements a BIM Execution Plan (BIMXP) 261

1.3 Background 262

1.3.1 AIA Effort 262

1.3.2 BIMForum Effort 262

1.3.3 LOD Definitions 262

2 LEVELS OF DEVELOPMENT 262

2.1 BIM as a Communication Tool 262

2.2 Level of Development vs. Level of Detail 263

2.3 Fundamental LOD Definitions 263

2.3.1 LOD 100 263

2.3.2 LOD 200 263

2.3.3 LOD 300 263

2.3.4 LOD 350 264

2.3.5 LOD 400 264

2.3.6 LOD 500 [NOT USED] 264

2.4 Example – Light Fixture: 264



- 3 USING THE SPECIFICATION 265
 - 3.1 Glossary 265
 - 3.1.1 Actual: 265
 - 3.1.2 BXP 265
 - 1.1.1 Specific: 265
 - 3.2 Details 265
 - 3.2.1 Order of Precedence 265
 - 3.2.2 LOD Definitions as Minimum Requirements 265
 - 3.2.3 LOD Definitions are Cumulative 265
 - 3.2.4 Model Element Author 265
 - 3.2.5 2D Supplementary Drawings 266
 - 3.3 Project-Specific Information 266
 - 3.3.1 Size Thresholds 266
 - 3.4 Using the Specification with a BIMXP 266
 - 3.4.1 Reliance 266
 - 3.4.2 Multiple uses 266
 - 3.4.3 Efficient sequencing 266
 - 3.4.4 Avoidance of over-modeling 266
 - 3.5 Implementation of the Specification 267
 - 3.5.1 Rely on the Model Element Table 267
 - 3.5.2 Include LOD Designations as Attributes of Individual Model Elements 267
- 4 ORGANIZATION OF THE SPECIFICATION 268
 - 4.1 Geometric and Attribute Information 268
 - 4.1.1 Part I: Element Geometry 268
 - 4.1.2 Part II: Associated Attribute Information 268
 - 4.1.3 Model Element Table 268
 - 4.1.4 Building Systems 268
 - 4.1.5 Milestones/Deliverables 269
 - 4.1.6 Attribute Tables 269
 - 4.1.7 Attribute Table Anatomy 270
 - 4.1.8 MEPF Attribute Tables 270
 - 4.1.9 Using the Attribute Tables 271
- 5 SUPPLEMENTARY GUIDELINES 272
 - 5.1 Clearly Define the Local X,Y,Z Origin: Basis for all LOD By Will Ikerd, P.E. 272



CHANGES FROM 2019 VERSION

Note – Changes are indicated with a change bar in the left margin. Items such as grammar corrections, added Unifomat descriptions, added Masterformat references, added or upgraded graphics, minor corrections/additions, etc. are marked with a bar but not detailed in this section.

Specific Changes

	No Changes
--	------------



UPDATES OF THIS DOCUMENT

Revision History

11/23/2020	Level of Development Specification Guide 2020 DRAFT FOR PUBLIC COMMENT	
01/18/2019	Level of Development Specification Guide 2019	
09/25/2018	Level of Development Specification Guide 2019 DRAFT FOR PUBLIC COMMENT	
09/04/2018	Level of Development Specification Guide 2018	
07/16/2018	Level of Development Specification Guide 2018 DRAFT FOR PUBLIC COMMENT	
11/07/2017	Level of Development Specification Guide 2017	

Revision Process

Public Comment

Each new version is first released as a draft for public comment. Feedback is evaluated and resolved prior to the publishing of the official version.

1 OVERVIEW

1.1 Description

The *Level of Development (LOD) Specification* is a reference that enables practitioners in the AEC Industry to specify and articulate with a high degree of clarity the content and reliability of Building Information Models (BIMs) at various stages in the design and construction process.

The Specification is a detailed interpretation of the LOD schema developed by the American Institute of Architects (AIA) for its *E202-2009 BIM and Digital Data Exhibit* and updated for its *G202-2013 Project BIM Protocol Form*⁴, defining and illustrating⁵ characteristics

⁴ AIA Contract Document *G202-2013, Building Information Modeling Protocol Form* is part of a series of digital practice documents the AIA published in June 2013. This series consists of *AIA E203™–2013, Building Information Modeling and Digital Data Exhibit*, *AIA G201™–2013, Project Digital Data Protocol Form*, and *AIA G202™–2013, Project Building Information Modeling Protocol Form*. For general information on the documents and downloadable samples see www.aia.org/digitaldocs. For executable versions of the documents see <http://www.aia.org/contractdocs>.

⁵ All images are intended to illustrate building conditions in compliance with common building codes. However, the images do not take into account site specific conditions, regional building codes and other important information that may require a material change for specific projects. These illustrations do not make representation for fitness for a particular project nor for code or design compliance.



of model elements of different building systems at different Levels of Development, organized according to CSI Uniformat 2010⁶. Its intent is to help explain the LOD framework and standardize its use so that it becomes more useful as a communication tool.

The LOD Specification adheres to the intent of the LOD schema as developed by the AIA, and as such it is important to emphasize several points here.

1.1.1 LODs and Design Phase

The LODs are not defined by design phases. Rather, design phase completion, as well as any other milestone or deliverable, can be defined through the LOD language. There are several important reasons for this approach:

- 3) There is currently no detailed standard for the design phases. Many architects have created in-house standards, but these differ from one firm to the next, and even within a single firm the requirements are sometimes adjusted to the needs of a project.
- 4) Building systems progress from concept to precise definition at different rates, so at any given time different elements will be at different points along this progression. At completion of the Schematic Design phase, for example, the model will include many elements at LOD 200, but will also include many at LOD 100, as well as some at LOD 300, and possibly even LOD 400.

1.1.2 LODs and Model Definition

There is no such thing as an “LOD ### model.” As previously noted, project models at any stage of delivery will invariably contain elements and assemblies at various levels of development. As an example, it is not logical to require an “LOD 200 model” at the completion of the schematic design phase. Instead, the “100% SD Model” will contain modeled elements at various levels of development.

1.2 Intent

1.2.1 Not a Set of Requirements

The Specification is not a set of requirements as to what is modeled when or by whom. Rather it is a language by which users can define these requirements for their own firms or projects. This clear articulation allows model authors to define what their models can be relied on for, and allows downstream users to clearly understand the usability and the limitations of models they are receiving.

To accomplish the Specification’s intent, its primary objectives are:

- 4) To help teams, including owners, to specify BIM deliverables and to get a clear picture of what will be included in a BIM deliverable
- 5) To help design managers explain to their teams the information and detail that needs to be provided at various points in the design process, and to track progress of their models
- 6) To allow downstream users to rely on specific information in models they receive from others.
- 7) To provide a standard that can be referenced by contracts and BIM execution plans.

1.2.2 Complements a BIM Execution Plan (BIMXP)

This Specification does not replace a project BIMXP, but rather is intended to be used in conjunction with such a plan, providing a means of defining models for specific information exchanges, milestones in a design work plan, and deliverables for specific functions.

⁶ UniFormat™ Numbers and Titles used in this publication are from UniFormat™, published by CSI and Construction Specifications Canada (CSC), and are used with permission from CSI. For a more in-depth explanation of UniFormat™ and its use in the construction industry visit <http://www.csinet.org> or contact CSI, 110 South Union Street, Suite 100, Alexandria, VA 22314. (800) 689-2900.

1.3 Background

1.3.1 AIA Effort

In 2008, the AIA published its first set of Level of Development definitions in AIA Document *E202™-2008 Building Information Modeling Protocol*. Due to the rapidly evolving nature of the use of BIM, the AIA evaluated the *E202-2008*, including the LOD definitions. The result is the updated and reconfigured Digital Practice documents, *AIA E203™-2013, Building Information Modeling and Digital Data Exhibit*, *AIA G201™-2013, Project Digital Data Protocol Form*, and *AIA G202™-2013, Project Building Information Modeling Protocol Form*, which are accompanied by a detailed guide document entitled *Guide and Instructions to the AIA Digital Practice Documents*. The AIA's updated Digital Practice documents include revised LOD definitions.

1.3.2 BIMForum Effort

In 2011 the BIMForum initiated the development of this LOD Specification and formed a working group comprising contributors from both the design and construction sides of the major disciplines. To help further the standardization and consistent use of the LOD schema, and to increase its usefulness as a foundation for collaboration, the AIA licensed the BIMForum to utilize its latest LOD definitions in this Specification. The BIMForum working group first interpreted the AIA's basic LOD definitions for each building system, and then compiled examples to illustrate the interpretations. Because BIM is being put to an ever-increasing number of uses, the group decided that it was beyond the initial scope to address all of them. Instead, the definitions were developed to address model element geometry, with three of the most common uses in mind – quantity take-off, 3D coordination and 3D control and planning. The group felt that in taking this approach the interpretations would be complete enough to support other uses.

1.3.3 LOD Definitions

The LOD definitions that are used in this Specification are identical to those published in the AIA's updated Digital Practice Documents, with two exceptions.

- 1) First, the working group identified the need for an LOD that would define model elements sufficiently developed to enable detailed coordination between disciplines – e.g. clash detection/avoidance, layout, etc. The requirements for this level are higher than those for 300, but not as high as those for 400, thus it was designated LOD 350. The AIA documents do not include LOD 350, but the associated *Guide and Instructions* references it.
- 2) Second, while LOD 500 is included in the AIA's LOD definitions, the working group did not feel it was necessary to further define and illustrate LOD 500 in this Specification because it relates to field verification. Accordingly, the expanded descriptions and graphic illustrations in this Specification are limited to LOD 100-400.

2 LEVELS OF DEVELOPMENT

2.1 BIM as a Communication Tool

The LOD schema addresses several issues that arise when a BIM is used as a communication or collaboration tool, i.e., when someone other than the author extracts information from it:

- 1) During the design process, building systems and components progress from a vague conceptual idea to a precise description. In the past, there has been no simple way to designate where a model element is along this path. The author knows, but others often don't.
- 2) It's easy to misinterpret the precision at which an element is modeled. Hand drawings range from pen strokes on a napkin to hard lines with dimensions called out, and the precision of the drawing can be inferred from its appearance. In a model though, a generic component placed approximately can look exactly the same as a specific component located precisely, so we need something besides appearance to tell the difference.
- 3) It is possible to infer or extract information from a BIM that the author doesn't intend – unconfirmed dimensions can be measured with precision, assembly information often exists before it's been finalized, etc. In the past, this issue has been sidestepped with all-encompassing disclaimers that basically say, "Since some of the information in the model is unreliable, you may not rely on any of it." The LOD framework allows model authors to clearly state the reliability of given model elements, so the concept becomes "Since some of the information in the model is unreliable, you may only rely on it for what I specifically say you can."

- 4) In a collaborative environment, where people other than the model author are depending on information from the model in order to move their own work forward, the design work plan takes on high importance – it is necessary for the model users to know when information will be available in order to plan their work. The LOD framework facilitates this.

The LOD Framework addresses these issues by providing an industry-developed standard to describe the state of development of various systems, assemblies, and components within a BIM. This standard enables consistency in communication and execution by facilitating the detailed definition of BIM milestones and deliverables.

2.2 Level of Development vs. Level of Detail

LOD is sometimes interpreted as Level of *Detail* rather than Level of *Development*. This Specification uses the concept of Level of *Development*. There are important differences.

Level of *Detail* is essentially how *much* detail is included in the model element. Level of *Development* is the *degree to which the element's geometry and attached information has been thought through* – the degree to which project team members may rely on the information when using the model.

In essence, Level of Detail can be thought of as input to the element, while Level of Development is reliable output.

2.3 Fundamental LOD Definitions ⁷

2.3.1 LOD 100

The Model Element may be graphically represented in the Model with a symbol or other generic representation, but does not satisfy the requirements for LOD 200. Information related to the Model Element (i.e. cost per square foot, tonnage of HVAC, etc.) can be derived from other Model Elements.

BIMForum Interpretation: LOD 100 elements are not geometric representations. Examples are information attached to other model elements or symbols showing the existence of a component but not its shape, size, or precise location. Any information derived from LOD 100 elements must be considered approximate.

2.3.2 LOD 200

The Model Element is graphically represented within the Model as a generic system, object, or assembly with approximate quantities, size, shape, location, and orientation. Non-graphic information may also be attached to the Model Element.

BIMForum interpretation: At this LOD elements are generic placeholders. They may be recognizable as the components they represent, or they may be volumes for space reservation. Any information derived from LOD 200 elements must be considered approximate.

2.3.3 LOD 300

The Model Element is graphically represented within the Model as a specific system, object or assembly in terms of quantity, size, shape, location, and orientation. Non-graphic information may also be attached to the Model Element.

BIMForum interpretation: The quantity, size, shape, location, and orientation of the element as designed can be measured directly from the model without referring to non-modeled information such as notes or dimension call-outs. The project origin is defined and the element is located accurately with respect to the project origin.

⁷ The definitions for LOD 100, 200, 300, 400, and 500 included in this Specification represent the updated language that appears in Contract Document G202–2013, Project Building Information Modeling Protocol Form. The LOD 100, 200, 300, 400 and 500 definitions are used by permission. Copyright © 2013. ACD Operations, LLC. All rights reserved. LOD 350 was developed by the BIMForum working group. Copyright © 2013. The BIMForum and ACD Operations. All rights reserved.

2.3.4 LOD 350

The Model Element is graphically represented within the Model as a specific system, object, or assembly in terms of quantity, size, shape, location, orientation, and interfaces with other building systems. Non-graphic information may also be attached to the Model Element.

BIMForum interpretation. Parts necessary for coordination of the element with nearby or attached elements are modeled. These parts will include such items as supports and connections. The quantity, size, shape, location, and orientation of the element as designed can be measured directly from the model without referring to non-modeled information such as notes or dimension call-outs.

2.3.5 LOD 400

The Model Element is graphically represented within the Model as a specific system, object or assembly in terms of size, shape, location, quantity, and orientation with detailing, fabrication, assembly, and installation information. Non-graphic information may also be attached to the Model Element.

BIMForum interpretation. An LOD 400 element is modeled at sufficient detail and accuracy for fabrication of the represented component. The quantity, size, shape, location, and orientation of the element as designed can be measured directly from the model without referring to non-modeled information such as notes or dimension call-outs.

2.3.6 LOD 500 [NOT USED]

The Model Element is a field verified representation in terms of size, shape, location, quantity, and orientation. Non-graphic information may also be attached to the Model Elements.

BIMForum interpretation. Since LOD 500 relates to field verification and is not an indication of progression to a higher level of model element geometry or non-graphic information, this Specification does not define or illustrate it.

2.4 Example – Light Fixture:

- 100 cost/sf attached to floor slabs
- 200 light fixture, generic/approximate size/shape/location
- 300 Design specified 2x4 troffer, specific size/shape/location
- 350 Actual model, Lightolier DPA2G12LS232, specific size/shape/location
- 400 As 350, plus special mounting details, as in a decorative soffit

3 USING THE SPECIFICATION

3.1 Glossary

The expanded definitions in this Specification use the following interpretations of these terms:

3.1.1 Actual:

The model element includes all the qualities of a specific element and is representative of the manufacturer's model to be installed or the construction intent of an assembly.

3.1.2 BXP, BEP

BIM Execution Plan. A comprehensive plan for employing BIM on a specific project. These plans usually address goals, BIM uses, milestones and deliverables, and BIM infrastructure. Some Resources:

- BIMForum. *BIM Project Execution Plan Guide*. <https://bimforum.org/Bxp>
- Pennsylvania State University College of Engineering. *BIM Project Execution Planning Guide*. <https://bim.psu.edu/>

1.1.1 Specific:

The quantity, size, shape, location, and orientation of the element as designed can be measured directly from the model without referring to non-modeled information such as notes or dimension call-outs.

3.2 Details

3.2.1 Order of Precedence

The body of this Specification expands on the Fundamental Definitions as they apply to specific building systems and sub-systems. In the event of any conflict, more specific expansions take precedence over less specific expansions and Fundamental Definitions, e.g. the expanded definitions for C1010 take precedence over those for C10, which in turn take precedence over the Fundamental Definitions.

3.2.2 LOD Definitions as Minimum Requirements

The LODs provide five snapshots of the progression of an element from conceptual to specified – there are many steps in this progression between the defined LODs. The LOD definitions, then, should be considered minimum requirements – i.e. an element has progressed to a given LOD only when all the requirements stated in the definition have been met.

3.2.3 LOD Definitions are Cumulative

For a given element each LOD definition includes the requirements of all previous LODs. Thus, for an element to qualify for LOD 300 it must meet all the requirements for 200 and 100 as well as those stated in the LOD 300 definition.

3.2.4 Model Element Author

This document does not prescribe who the author of a particular component at a given LOD should be – the sequence of responsibility for modeling various systems will vary from one project to another. To accommodate this variation this document defers to the concept of Model Element Author (MEA) as defined in the *AIA E203-2013*: “The Model Element Author is the entity (or individual) responsible



for managing and coordinating the development of a specific Model Element to the LOD required for an identified Project milestone, regardless of who is responsible for providing the content in the Model Element." ⁸

3.2.5 2D Supplementary Drawings

In current practice models are often supplemented with 2D information such as detail drawings. This Specification does not address this supplementation, but rather deals only with what is modeled in 3D and non-graphic information associated with the modeled elements.

3.3 Project-Specific Information

As mentioned in the Overview above, this Specification is intended to be used in conjunction with a project BIMXP. Many information needs will vary from project to project, even for identical elements. This kind of information is therefore not included in the LOD definitions specified here, but rather is left to be addressed in individual BIMXPs. The following are some notable examples.

3.3.1 Size Thresholds

In most projects, a determination is made to model certain elements only if they are over a specified size – e.g. conduit less than 1/2" (10 mm) diameter is not modeled. These size thresholds do not consistently correspond to certain LODs, and they vary from project to project. Thus, they are not specified in the LOD definitions but rather in the project's BIMXP, for example using the "Notes" cells in the Model Element Table of the *AIA G202-2013*.

3.4 Using the Specification with a BIMXP

Most BIMXPs include a section that details milestones as well as information exchanges – models to be produced to exchange specific information at specific points in a specific BIM use. In most cases, though, current practice is to accompany these models with the common "for reference only" disclaimer, diluting the effectiveness of the exchange. Referencing this Specification in the BIMXP and using it to concisely define the milestone and information exchange models brings many efficiencies to the process – among them:

3.4.1 Reliance

As noted above (see "BIM as a Communication Tool"), a major problem with allowing others to rely on a BIM is that it can contain information the author doesn't intend. By defining a model through the LOD Specification the author can limit reliance to only what he/she specifically states.

3.4.2 Multiple uses

Much model information is common across several information exchanges. This Specification facilitates the definition of models that will support multiple exchanges.

3.4.3 Efficient sequencing

The development of models as the design and construction process progresses follows logical sequences – much information depending on the prior development of other information. The definition of milestones, information exchanges, and other deliverables through this Specification facilitates the orderly sequencing of models to align with efficient development of information.

3.4.4 Avoidance of over-modeling

The LOD Specification facilitates the application of a pull-planning process to the modeling effort, limiting the development of model elements and information to that which the team identifies as useful.

⁸ AIA Document *E203-2013 Building Information Modeling and Digital Data Exhibit*, Article 1.4.6. Copyright © American Institute of Architects 2013. All rights reserved. Definition quoted here by permission.

Note that the definition and sequencing of models usually cannot be set in stone when the BIMXP is first developed. In most cases the modeling plan must evolve as the project progresses.

3.5 Implementation of the Specification

Currently, two methods of implementation have been developed.

3.5.1 Rely on the Model Element Table

Project team refers to a Model Element Table such Article 3.3 of the AIA G202-2013 or Part II of this Specification for the LODs of model elements. In this method, all elements referred to in a given Model Element Table line item are assumed to be at the LOD stated there. E.g. if the table lists interior doors as LOD 200 for a given model, all interior doors within the model are assumed to be at LOD 200.

3.5.2 Include LOD Designations as Attributes of Individual Model Elements

All elements within the model are provided with two attributes – Current LOD (the actual LOD of the element) and Target LOD (the LOD specified for that element in the Model Element Table). Elements default to a Current LOD of 100 or 200 as appropriate, and this attribute is elevated as the element is more fully developed. This method offers more flexibility and reliability, allowing differentiation between individual elements within a single model element table line item. Several software offerings provide the functionality of highlighting elements of various LODs or elements whose Current LOD is less than the Target LOD.

4 ORGANIZATION OF THE SPECIFICATION

4.1 Geometric and Attribute Information

To facilitate use of this Specification Attachment 1, Model Development Specification (MDS) has been provided. This attachment is a set of spreadsheets that can be used to collect and correlate LOD Information for a specific project.

A model element can contain two types of information: a) the element's geometry and b) associated numeric and/or textual attributes. To address these types of information this Specification contains two parts:

4.1.1 Part I: Element Geometry

Part I consists of narrative descriptions and illustrations of specific model elements at each LOD. Part I forms the bulk of this document.

4.1.2 Part II: Associated Attribute Information

Part II is contained in Attachment 1, a workbook that begins with the Model Element Table which mirrors the layout of the Model Element Table in the AIA G202-2013 Building Information Modeling Protocol Form, and can be referenced by that document. The Model Element Table references Attribute Tables that contain attribute information for various building systems.

4.1.3 Model Element Table

UniFormat Level	1	2	3	4	Use on this project	Building Systems	Relevant Attribute Tables	SD			DD			CD			Estimating Est. 1			Estimating Bid Pkg.			LEED Cert. Check			LEED Cert. Submittal		
								LOD	MEA	Notes	LOD	MEA	Notes	LOD	MEA	Notes	LOD	MEA	Notes	LOD	MEA	Notes	LOD	MEA	Notes	LOD	MEA	Notes
A	10					Substructure																						
A	10					Foundations	A, B Precast Concrete; A, B Wood; A, B Masonry; A, B Precast Concrete																					
A	10	10				Standard Foundations	A, B Precast Concrete; A, B Wood; A, B Masonry; A, B Precast Concrete																					
A	10	10	.10			Wall Foundations	A, B Precast Concrete; A, B Wood; A, B Masonry; A, B Precast Concrete																					
A	10	10	.30			Column Foundations	A, B Precast Concrete; A, B Wood; A, B Masonry; A, B Precast Concrete																					
A	10	20				Special Foundations	A, B Precast Concrete; A, B Wood; A, B Masonry; A, B Precast Concrete																					
A	10	20	.80			Grade Beams	A, B Precast Concrete; A, B Wood; A, B Masonry; A, B Precast Concrete																					
A	20					Subgrade Enclosures	A, B Precast Concrete; A, B Wood; A, B Masonry; A, B Precast Concrete																					
A	20	10				Walls for Subgrade Enclosures	A, B Precast Concrete; A, B Wood; A, B Masonry; A, B Precast Concrete																					
A	40					Slabs-on-Grade	A, B Precast Concrete																					
A	40	10				Standard Slabs-on-Grade	A, B Precast Concrete																					
A	40	20				Structural Slabs-on-Grade	A, B Precast Concrete																					
B	10					SHELL																						
B	10					Superstructure																						
B	10	10				Floor Construction	A, B Cast Formed Metal Framing; A, B Masonry; A, B Metal Deck; A, B Precast Concrete; A, B Steel Joist; A, B Structural Steel; A, B Concrete; A, B Wood																					
B	10	10	.10			Floor Structural Frame	A, B Precast Concrete																					
B	10	10	.10			Concrete	A, B Precast Concrete																					
B	10	10	.10			Masonry	A, B Masonry																					

Figure 1

4.1.4 Building Systems

The rows of the Model Element Table (Figure 1) are building elements listed in accordance with CSI Unifomat 2010. The table also lists Relevant Attribute Tables for each system, referring to the tabs containing attribute information for the associated system(s). If desired, users can add Attribute Tables for specific line items.

4.1.5 Milestones/Deliverables

The table includes columns for defining the LODs for various milestones within a project. Each milestone column has three sub-columns: Level of Development (LOD), Model Element Author (MEA), and Notes. The table in Attachment 1 shows standard milestones for the completion of the traditional design phases as well as examples of Project-Specific Milestones for interim reviews, specific deliverables, BIM-Use information exchanges, etc. Users are encouraged to modify and add to these milestones as necessary. Once the milestones for a project have been determined, they can be re-ordered into a logical sequence as in Figure 2.

Uni	Format	Level	Use on this project	Relevant Attribute Tables	SD			Estimating			DD			LEED Cert.			CD			Estimating			LEED Cert		
					Date	ME	Notes	Est. 1	ME	Notes	Date	ME	Notes	Check	Date	ME	Notes	Date	ME	Notes	Est. 1	ME	Notes	Date	ME
A	10			FOUNDATIONS																					
A	10	10		Standard Foundations																					
A	10	10	.10	Wall Foundations																					
A	10	10	.30	Column Foundations																					
A	10	20		Special Foundations																					
A	10	20	.80	Grade Beams																					
A	20			Subgrade Enclosures																					
A	20	10		Walls for Subgrade Enclosures																					
A	40			Slabs-on-Grade																					
A	40	10		Standard Slabs-on-Grade																					
A	40	20		Structural Slabs-on-Grade																					
B	10			SHELL																					
B	10	10		Floor Construction																					
B	10	10	.10	Floor Structural Frame																					
B	10	10	.10	Concrete																					
B	10	10	.10	Masonry																					

Figure 2

4.1.6 Attribute Tables

A	B	C	D	E	F	G	H	I	J	L	M	N	O				
B - Ext. Wall																	
1	Baseline	This work is licensed under the Creative Commons Attribution-NonCommercial 4.0 International License															
2	Additional	Part 1 - Attribute Description											Part 2 - Project-Specific Milestones (Examples)				
3	Attribute	Date Type	Units - Imp.	Units - Metric	Option Examples	Commentary								Estimating	Estimating	LEED Cert.	LEED Cert
4	Construction	Text			framed, unit masonry, paneled, EIFS, etc.									Est. 1	Bid Pkg.	Check	Submittal
5	Material - Skin	Text			tiles, composite, sheet metal, etc.												
6	Material - Substrate	Text			corrugated metal, plywood, composite panels, etc.												
7	Material - Insulation	Text															
8	Wall Type	Text															
9	Thermal Resistance	Number	R: h-ft ² -F/Btu	m ² /C/W													
10	Thermal Transmittance	Number	U: Btu/(h-ft ² -F/Btu)	W/(m ² °C)													
11	Target LOD	Number	LOD #	LOD #	100, 200, 300, 350, 400												
12	Current LOD	Number	LOD #	LOD #	100, 200, 300, 350, 400												
13	Wind Load Capacity (drag)	Number	psf	Pa													
14	Wind Load Capacity (pressure)	Number	psf	Pa													
15	Fire Rating	Text			options: [UL label - A,B,C,D,E,S]												
16	Impact resistance	Text			options:[T/F, class]												
17	UV Resistance	Text			options:[T/F, class]												
18	Air Infiltration	Text			options:[T/F, class]												
19	Sound Transmission	Text															
20	Acoustic Rating	Text															
21	Security Rating	Text															
22	Glazing Area	Number	ft ²	m ²		Fraction of the glazing area relative to the total area of the filling element.											
23	Combustible	Logical			T/F	Indicates whether the object is made from combustible material.											
24	SurfaceSpreadofFlame	Text															
25	IsExternal	Logical			T/F	Should be set to TRUE for all external walls.											
26	Shop Submittal Parameters:																
27	Date - Issued For Construction	Date Time	yyyy-mm-ddThh:mm	yyyy-mm-ddThh:mm	(DateIFC)												
28	Date - Permitted	Date Time	yyyy-mm-ddThh:mm	yyyy-mm-ddThh:mm	(DatePermitted)												
29	Date - received for Shop Detailing	Date Time	yyyy-mm-ddThh:mm	yyyy-mm-ddThh:mm	(DateReceivedForShopDet)												
30	Date - Detailing Submitted for EOR review \ Out For Approval	Date Time	yyyy-mm-ddThh:mm	yyyy-mm-ddThh:mm	(DateOutForApproval)												
31	Date - Final Erection Drawings Approved for Fab	Date Time	yyyy-mm-ddThh:mm	yyyy-mm-ddThh:mm	(DateFinalForFab)												
32	Date - Fabrication Start	Date Time	yyyy-mm-ddThh:mm	yyyy-mm-ddThh:mm	(DateFabStart)												
33	Date - Fabrication End	Date Time	yyyy-mm-ddThh:mm	yyyy-mm-ddThh:mm	(DateFabEnd)												
34	Date - Fabrication Shipped	Date Time	yyyy-mm-ddThh:mm	yyyy-mm-ddThh:mm	(DateFabShip)												
35	Date - Fabrication Received	Date Time	yyyy-mm-ddThh:mm	yyyy-mm-ddThh:mm	(DateFabReceived)												
36	Date - Erection	Date Time	yyyy-mm-ddThh:mm	yyyy-mm-ddThh:mm	(DateErected)												
37	Date - Inspected	Date Time	yyyy-mm-ddThh:mm	yyyy-mm-ddThh:mm	(DateInspected)												

Figure 3



4.1.7 Attribute Table Anatomy

Attribute Tables consist of three parts.

- 1) Part 1, Attribute Description, lists Attributes relevant to the associated building system(s).
 - Attributes are grouped into two categories as shown – Baseline and Additional.
 - The Baseline is the suggested list of attributes to be populated when no other requirements are known (BIM Uses, specific deliverables, etc.).
 - The Additional category may be thought of as a “shopping list” – a list of possible attributes the team may want to consider.
 - Data Types. For simplicity, the published Attribute Tables use only the following data types, but users setting up data for use in specific software may want to add others.

Text	An alphanumeric string not intended for use in calculations. E.g. room numbers are often considered text (even where they only contain numbers) since the numbers are not useful for calculations.
Number	A numerical value that can be entered directly into a program that will use it as input to calculations. Note that no distinction is made here between integers and real numbers.
Logical	Boolean in computer science terminology. A binary yes/no indication. Values for this type can be T or F, 1 or 0.
Date	ISO format is used in these tables: yyyy-mm-dd
Time	ISO format is used in these tables: hh:mm:ss
Datetime	ISO format is used in these tables: yyyy-mm-ddThh:mm:ss

- 2) Part 2, Milestones, is used to mark the attributes required for specific milestones and deliverables. The tables in Attachment 1 include example milestones, but users will customize the tables by copying the milestones they created for the Model Element Table.

4.1.8 MEPF Attribute Tables

The MEPF attribute tables use a somewhat different format than other sections, since components from multiple systems might be used to make up a specific element. For example, an air handler is primarily a D30 HVAC element, but can include plumbing, fire protection and electrical elements as well.

The MEP Systems tabs are grouped into two types:

- **System component elements:** D20 Plumbing, D30 HVAC, D40 Fire Protection and D50 Electrical.
- **System distribution elements** such as ducts, pipes, and cables: D Air Distribution, D Fluid Gas Distribution and D Electrical Distribution.

MEPF attribute tables are broken down into two main sections

- **Global:** Attributes that are common to all elements within the table
- **Item-Specific:** The suggested set of additional attributes that are specific to an individual type of element. In many tables, the Individual elements are organized into a hierarchy of classes and sub-classes. In these cases, the attributes applicable to a specific element include those listed for the element itself plus those listed in any of the classes above it in the hierarchy. E.g. as Figure 4 shows, the attributes for an oil meter include all those shown in bold.

Note: System Component elements use both the Global and Item-Specific attributes sections, while System Distribution elements use only the Item-Specific attribute section.

Figure 4

4.1.9 Using the Attribute Tables

There are many ways to use the Attribute Tables – three are shown here.

- 1) Project teams adopt the Baseline attribute lists. The pre-populated correlation between Attributes and LODs represents current practices of proficient BIM users in the AEC industry.
- 2) Project teams create a custom correlation between LODs and Attribute population requirements. In this case the project team would edit the LOD Profile section to reflect the specific requirements of the project.
- 3) Project teams create new, project specific milestones and define Attribute population requirements in the Milestones sections. This approach will give project teams the greatest flexibility for defining Attribute population requirements.

Note that the element attribute author can be entered in the LOD profile instead of an “x” to indicate who is responsible for providing the information.



5 SUPPLEMENTARY GUIDELINES

5.1 Clearly Define the Local X,Y,Z Origin: Basis for all LOD

By Will Ikerd, P.E.

This is the simplest rule to implement and sadly the most common and costly single item that goes unaddressed in ignorance on projects. The project general notes of the design drawings and specification should clearly define the local relative Building X, Y, Z coordinates that other trades will use in construction that are coordinated with the structural model. It is recommended to define the X,Y coordinates of the origin (Revit Project Internal 0,0) relative to the Southwest most column grid intersection with a South and West offset of 10, 100 or 1000 feet depending on the project size. The Southwest column intersection is chosen so the structure is in a positive X-Y coordinate system. The offsets of 10, 100 or 1000 feet South and West of the origin are so that any portions of the building that extend South or West of the project origin grid intersections will also be within a positive X-Y coordinate system. The Z elevation should be defined as 0, 100' or absolute elevation depending on firm preference. It is common to use a relative 100' elevation. Plan North is established as being in the positive Y direction.

These rules above form the basis of the project's "local" relative Building coordinate system that becomes part of the legal definition in contracts related to the model and references to LOD. This process aids linking the structural model to third party applications that are based on traditional CAD coordinate systems. A benefit of defining the local relative origin early and stating it in the project's general notes is other models that are developed for shop drawings from the construction documents have a point of reference to follow when they are submitted for review. This local relative building coordinate system is also tied back to the civil engineers' state plane coordinate system referred to as the Civil coordinates in Civil 3D. Larger products will also have a Campus coordinate system normally near the Southwest corner of the project site. There can also be an Object coordinate system used for items such as equipment models. This Object coordinate system is typically referenced relative to the Local Building coordinate system in the form of a grid line offset and floor elevation offset. The Civil coordinate system defined by the state plane absolute coordinate system will then have a set relationship with the structural local Building coordinate system of an X, Y, and Z offset and a Z-axis rotation. Using this set relationship between the Civil absolute and relative Building coordinate system, all federated project models can be easily converted to absolute or relative systems depending on the owner's preference in their facility management models. Ideally, the owner will have a clearly written documentation in the BIM Execution Plan that accurately defines the relationship between Object, Building, Campus and Civil coordinate systems.

In summary, these 4 coordinate systems are:

Object: relative system that defines items such as assemblies and equipment in the structure. For example, the Air Handler Unit will have a relative Object coordinate that reference the Local Building coordinate which defines the mechanical room it resides in.

Building, Local: relative building coordinate system normally defined so that the entire structure is in positive point coordinates. For structure, this should be defined in the construction documents.

Campus, Site: relative coordinate system of the building's site defined so that the entire site is in positive point coordinates.

Civil (State Plane): Absolute coordinate system with Northing and Easting used by surveyors and civil engineers. This is also used by owners tying in their BIM to GIS applications for example.

Steps and Jobs to be done:

Structural engineer needs to be able to set the LOD of the origin of the project with the Architect at the start of the DD phase of the project. This needs to be coordinated with the civil engineer and site surveyors state plane coordinates. Following this, any manufacture will reference the building coordinates for the placing of their content.

CAMPUS COORDINATES

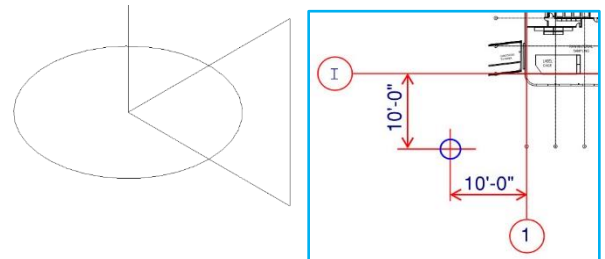
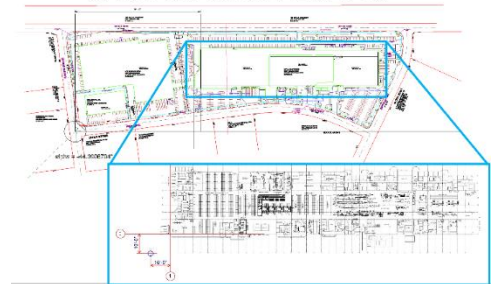

LOCAL BUILDING COORDINATES

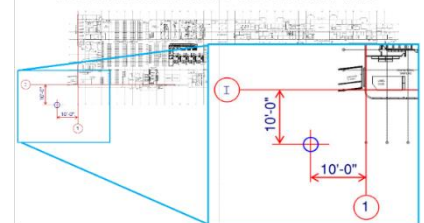

SITE PLAN & CAMPUS COORDINATES

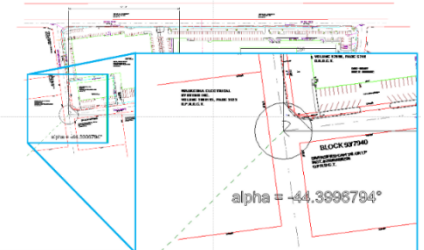

Images courtesy of lkerd.com.